



***The Ultimate***  
Flags, Flagpoles &  
Accessories Catalog

AMERICA 250 EDITION



**EDER FLAG**<sup>®</sup>

American Made ★ Employee Owned



**DEAR VALUED CUSTOMERS,**

In 2026, our nation marks a historic milestone—250 years of liberty, unity, and the enduring symbol of the American flag. For over a century, Eder Flag has proudly supplied the flags and flagpoles that tell that story—on front porches, town squares, stadium fields and national landmarks alike.

This special edition catalog honors our shared heritage and looks forward to the future. We invite you to explore our full line of American-made flags and industry-leading flagpoles as we celebrate this once-in-a-generation moment—together.

***– The Eder Flag Team***

*America*  
**250**

**HONORING THE PAST.**  
*Inspiring the Future.*

In 1976, as America celebrated its 200th birthday, Eder Flag was proudly producing thousands of flags to mark the nation's Bicentennial. From historical flag sets and Bennington flags to the grandest of them all - the American Flag, our dedication to craftsmanship and patriotism flew high across the country.

Today, nearly 50 years later, we're doing the same - only greater. With skilled hands, time honored methods, and the same unwavering spirit, Eder Flag continues to weave the story of our nation - one star, one stripe, one stitch at a time.

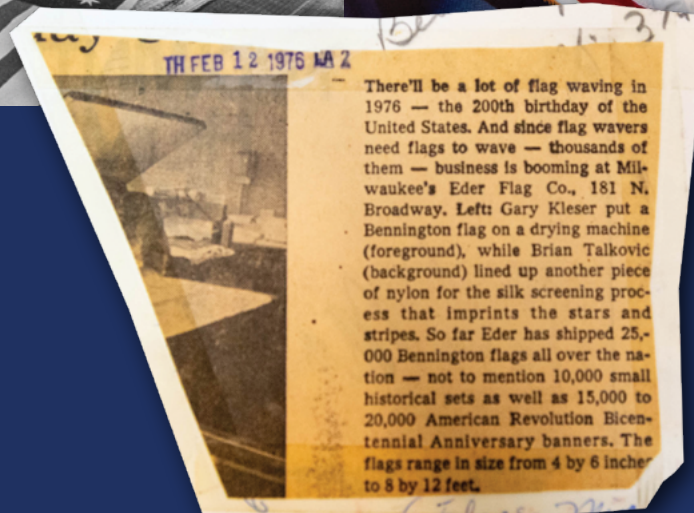

# TABLE OF CONTENTS

## MILITARY ANNIVERSARY FLAGS

Page 79



## DELUXE LED SOLAR FLAGPOLE LIGHT

Page 175



### FLAG TYPES, MATERIAL AND ADD-ONS 4

- Mounted Flags 4
- Indoor/Parade Flags 4
- Outdoor Flags 5
- Caring for Your New Flag 5

### U.S. FLAGS 6

- Eder Flag American Made U.S. Flags 6
- Watch The Flagmakers 6
- Flag Features 7
  - U.S. Flag Construction Specifications 7
  - Stars 7
  - Stitching 7
  - Header Features 8
  - Fly Stitching Reinforcements 9
  - Vertical Stitching and Reinforced Corners 9
- Outdoor Flags 10
  - Poly-Max™ U.S. Flags 10
  - Endura-Nylon™ U.S. Flags 11
  - Modified U.S. Flags 12
  - Modified U.S. Flag Construction Specifications 13
  - Modified U.S. Flag Construction Options 14
  - 3' X 5' Endura-Nylon II U.S. Outdoor Flags 16
  - Endura-Nylon U.S. Outdoor Banner Flags 16
  - Endura-PC™ U.S. Outdoor Flag 16
  - Endura-Tex™ Cotton U.S. Outdoor Flags 17
  - Sun-Brite™ Nylon U.S. Flags 17
- Residential Outdoor Sets 18
  - Replacement Parts for Flag Sets 18
  - Spinning Pole Flag Sets 19
  - Regal Flag Sets 19
- Indoor & Sets 20
  - Deluxe U.S. Nylon Indoor/Parade Flag Sets 20
  - Freedom Flag Set 21
- Mounted 23
- Fans, Decorations & Bunting 24

### STATE AND TERRITORY FLAGS 26

- State Indoor & Outdoor Flags 26
  - Complete 50 State Flag Sets 26
- State Outdoor Flags 27
- Texas Outdoor Flags 31
- Territory Outdoor Flags 32
- Chicago & District of Columbia Outdoor Flags 32

### FLAGS OF THE WORLD 33

- Indoor & Outdoor Flags 33
  - Complete World Organization Flag Sets 33
- Outdoor Flags 34
- Canadian Provinces & Territories 52

### RELIGIOUS FLAGS & SETS 53

- Christian Flags 53
- Israel Flags 54
- United Methodist Flags 54
- Papal Flags 55
- Additional Religious Flags 55

### INDOOR & PARADE ACCESSORIES 56

- Ornaments 56
- Floor Stands 59
- Poles 61
- Miscellaneous Accessories 66
- Table Bases 69

### HISTORICAL FLAGS OF THE U.S. 70

- Evolution of Old Glory 70
- 3' X 5' Outdoor Nylon 72

### MILITARY AND CIVILIAN SERVICE 74

- Military 74
- Civilian 80
- Accessories 81
  - Thermoplastic Memorial Markers 81
  - Memorial Cases 82

### NAUTICAL FLAGS 83

### SPECIALTY FLAGS 86

- Celebration 86
- Unity 87
- Message 88
- Racing & Sports 90

**NATURAL ALUMINUM FLYING EAGLES**

Page 146



<b>ATTENTION FLAGS</b>	<b>92</b>
• Solid Color	92
• Feather & Tear Drop Accessories	92
• Feather Flag Accessories	92
• Tear Drop Flag Accessories	93
<b>CUSTOM FLAGS &amp; BANNERS</b>	<b>94</b>
• Custom Printed Flags and Banners	94
• Appliqué Flags	96
<b>BRACKETS, HOLDERS &amp; ACCESSORIES</b>	<b>97</b>
• Deluxe Banner Arm Mounting Sets	97
• Neverfurls	105
<b>OUTDOOR FLAGPOLES</b>	<b>106</b>
• Residential Flagpoles	106
• Fly It Flagpole Set with Flag	112
• White Titan Flagpole Sets	113
• Homesteader Flagpole Sets (No Flag)	114
• 20' Tapered Homesteader Flagpole	115
• Commercial Grade - American Made	116
• Outdoor Flagpole Lifetime Warranty	117
• M-Winch Highlights	118
• Flagpole Height and Flag Size	119
• Halyard Systems	120
• Location	122
• Ground Set Cone Tapered Aluminum Flagpoles Wind Load Chart	122
• Flagpole Finishes	123

**TEXAS FLAGS**

Fully sewn outdoor nylon & poly-max with vertical stitching & reinforced corners

Page 31



• Commercial Flagpoles	<b>124</b>
• Architectural Series	124
• Hurricane Series	125
• Economy Extra Series	126
• Atlas Series	127
• Special Budget Series	128
• Sectional Special Budget Series	129
• Deluxe IH with M-Winch	130
• Hurricane Deluxe IH Series with M-Winch	132
• Vanguard Series	133
• Nautical Series with Yardarm	134
• Nautical Series with Yardarm & Gaff	136
• Alternative Bases	139
• Vertical Wall Mount Series	140
• Outrigger Wall Mount Series	142
• Franklin Series	144
<b>OUTDOOR FLAGPOLE ACCESSORIES</b>	<b>145</b>
• Ornaments	145
• Trucks & Accessories	147
• Cleats, Halyard, Snaps & Accessories	154
• Internal Halyard Parts & Accessories	161
• Flash Collars - Standard	170
• Flash Collars - Split	171
• Sleeves, Lights & Miscellaneous	173
• Galvanized Steel Foundation Sleeves	173
<b>TERMS AND CONDITIONS</b>	<b>177</b>
<b>RETAILER TOOLS</b>	<b>179</b>
<b>FLAG ETIQUETTE</b>	
• When to Display the American Flag	8
• American Flag Display Guidelines	13
• Conduct During Hoisting, Lowering, or Passing of the American Flag	51
• Honoring the American Flag:	
How to Retire It with Dignity	91
• How to Fly the American Flag	106
• Flag Etiquette Brochure	109

# FLAG TYPES, MATERIALS AND ADD-ONS

## MOUNTED FLAGS

Small, handheld flags, also known as mini or stick flags, are miniature versions of national or other symbolic flags securely mounted on a stick for easy waving or display. They can range in sizes from 4" x 6" to 12" x 18" and the flags are offered in a variety of materials.



### LIGHTWEIGHT POLY COTTON

#### U.S. Flags Only

- Printed on lightweight cotton.
- Hemmed on all four sides.
- **Most popular economy choice.**



### COTTON NO-FRAY

- Made of special no-fray material that doesn't require hemming.
- Mounted on 3/16" x 10" natural wood staff with no tip.
- **Ideal for larger promotions and giveaways.**

## INDOOR / PARADE FLAGS

### POLE HEM OR POLE HEM & FRINGE ADD-ON

Add the pricing below to any outdoor flag to determine the price for an indoor/parade flag. All pole hems include a leather tab for mounting flag on a pole. Fringe is 2" wide.

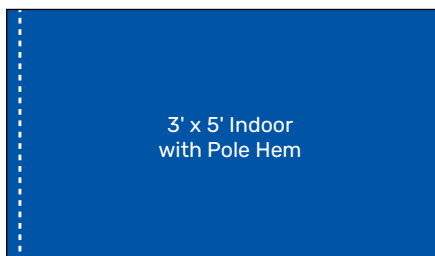

Flag Size	Pole Hem Only
2' x 3'	\$17.00
3' x 5'	21.50
4' x 6'	24.00
5' x 8'	29.50
6' x 10'	39.00



Flag Size	Pole Hem & Fringe
2' x 3'	\$34.00
3' x 5'	43.00
4' x 6'	48.00
5' x 8'	61.00
6' x 10'	79.00

## OUTDOOR FLAGS

Outdoor flags are designed to withstand the elements and are typically used for display purposes, both decorative and symbolic. Our outdoor flags are made from the most durable materials like nylon and polyester and feature reinforced stitching and a sturdy canvas header to ensure longevity in outdoor conditions.

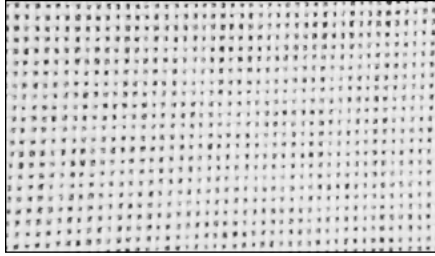

### POLY-MAX™ FLAGS

- Made of 2-ply 100% polyester bunting.
- Open weave construction reduces wind resistance, increasing flag life.
- Extremely durable.
- Finished with canvas header and brass grommets.
- **Ideal for commercial applications and high wind areas.**

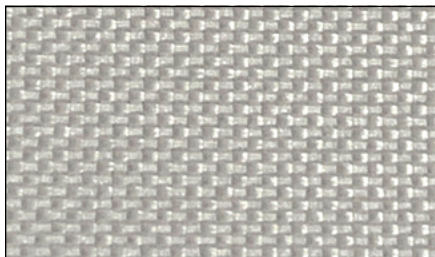

### ENDURA-NYLON™ FLAGS

- Made of 100% heavyweight, 200-denier nylon bunting.
- Aniline-dyed for vibrant color and enhanced UV resistance.
- Treated to resist fading.
- Fast drying.
- Finished with canvas header and brass grommets.
- **Flies in the slightest breeze.**

## CARING FOR YOUR NEW FLAG



Your flag is more than fabric—it's a symbol of honor, pride, and tradition. Every flag endures the elements differently, and with proper care, you can extend its life and keep it flying beautifully. Take these simple steps to protect your flag and preserve its beauty:



Avoid exposing your flag to high winds or extreme weather conditions, which can shorten the overall life of a flag considerably. Be proactive and take the flag down BEFORE inclement weather occurs. If storing the flag and it has become wet, be sure to spread the flag out to dry completely before folding.



If needed, hand-wash with mild detergent and cold water. Rinse with cold water and lay flat to air dry.



Repair the flag after initial signs of fraying and have back-up flags available, rotating them often.



Do not fly a flag where it can come into contact with other surfaces such as building walls, gutters, trees, wires, etc. Your flag could quickly become tattered or torn.



**100% MADE IN AMERICA**

- Every flag is fully manufactured in the United States, using American-sourced materials and labor. This dedication supports U.S. jobs and meets the Federal Trade Commission’s strict “Made in USA” guidelines.
- Eder Flag is a proud, certified member of the **Flag Manufacturers Association of America (FMAA)**, ensuring our products meet verified standards of American origin.



**EDER FLAG AMERICAN MADE U.S. FLAGS**



Eder Flag’s handcrafted U.S. flags are more than just fabric—they represent Made in America values, skilled craftsmanship, and a deep-rooted tradition of excellence.

**EXPERT CRAFTSMANSHIP**

- Each flag is meticulously sewn by experienced flag makers.
- We focus on precision stitching, reinforced fly ends, and intricate star detailing—whether embroidered or appliquéd—for lasting durability and beauty.

**A TRADITION OF EXCELLENCE**

- Established in 1887, Eder Flag has over a century of experience in flag making.
- We uphold time-honored techniques passed down through generations of skilled flag makers.
- Our legacy reflects a steadfast commitment to quality, durability, and American pride.
- Trusted by government agencies and municipalities, veterans, and patriotic families across the country.

**WATCH THE FLAGMAKERS**

The Flagmakers offers a powerful, behind-the-scenes look at the people and purpose behind Eder Flag. It brings the story to life in ways that go beyond words on a page:

- **Humanizes the Craft:** The film follows the diverse team of immigrants, refugees, and lifelong Americans who come together every day to handcraft U.S. flags. Their stories reflect the very values the flags stand for—resilience, unity, and hope.
- **Illustrates Our Values:** Viewers see firsthand how Eder Flag’s commitment to Made in America, skilled craftsmanship, and a tradition of excellence is carried out on the factory floor.
- **Deepens the Meaning of Eder Flag Product:** The documentary makes it clear that each flag is not just sewn—it’s shaped by real lives and meaningful stories.

**AS FEATURED IN**



THE **FLAGMAKERS**

Every flag is proudly handcrafted at our Eder Flag headquarters in Oak Creek, Wisconsin.



Meet the staff that help handcraft our flags.

## U.S. FLAG CONSTRUCTION SPECIFICATIONS

Flag Size	Header Width	Fly End Lock Stitching	No. of Thimbles	No. of Grommets	Grommet Reinforcement	Corner Patches	Zig Zag Stitching On Each Fly End Corner	Stars
3' x 5'	1-1/2"	4 rows	–	2	–	–	–	Embroidered
4' x 6'	1-1/2"	4 rows	–	2	–	–	–	Embroidered
5' x 8'	1-1/2"	4 rows	–	2	–	–	–	Embroidered
5' x 9-1/2'	1-1/2"	4 rows	–	2	–	–	–	Embroidered
6' x 10'	2"	6 rows	–	2	–	–	–	Embroidered
8' x 12'	2"	6 rows	2	1	Yes	–	Yes	Embroidered
10' x 15'	2"	6 rows	2	1	Yes	Yes	Yes	Embroidered
10' x 19'	2"	6 rows	2	1	Yes	Yes	Yes	Embroidered
12' x 18'	2"	6 rows	2	1	Yes	Yes	Yes	Embroidered
15' x 25'	2"	6 rows	2	3	Yes	Yes	Yes	Appliqued
20' x 30'	3" doubled	6 rows	2	3	Yes	Yes	Yes	Appliqued
20' x 38'	3" doubled	6 rows	2	3	Yes	Yes	Yes	Appliqued
25' x 40'	3" doubled	8 rows	2	5	Yes	Yes	Yes	Appliqued
30' x 50'	3" doubled	8 rows	2	7	Yes	Yes	Yes	Appliqued
30' x 60'	3" doubled	8 rows	2	7	Yes	Yes	Yes	Appliqued
40' x 70'	3" doubled	8 rows	2	9	Yes	Yes	Yes	Appliqued
40' x 75'	3" doubled	8 rows	2	9	Yes	Yes	Yes	Appliqued
50' x 80'	3" doubled	8 rows	2	11	Yes	Yes	Yes	Appliqued

## STARS

### EMBROIDERED STARS

12' x 18' and smaller flags come standard with embroidered white stars.



### APPLIQUED STARS

15' x 25' and larger flags have opaque white nylon stars with zigzag stitching throughout.



## STITCHING

### CHAIN-STITCHED

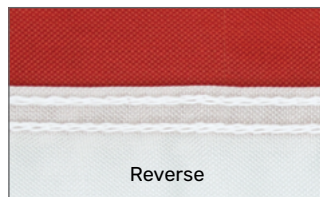
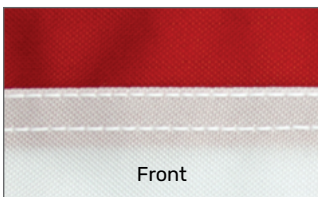

### LOCK-STITCHED

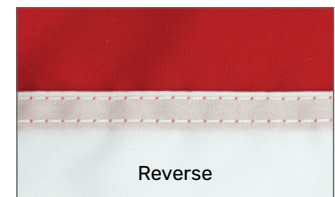
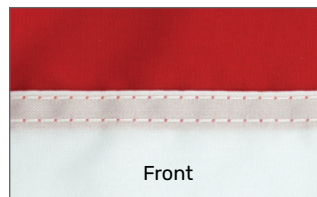

## HEADER FEATURES

### HEADERS

All headers are made with a heavy-duty, white cotton-polyester blend army duck cloth.

2x3 through 6x10 flags are constructed with canvas header and brass grommets.



### ROPE THIMBLE

8' x 12' and larger flags include plated steel rope thimbles. Thimbles are attached to white rope using a triple crimped rope sleeve. The length of the rope is sewn into the header to stabilize its position and prevent bunching.

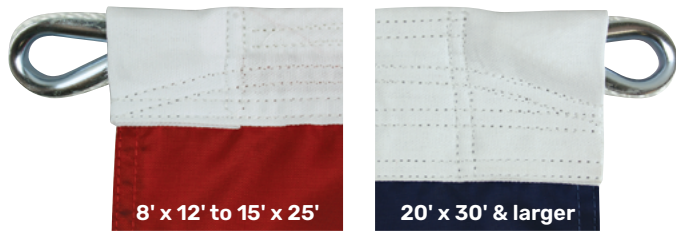

### GROMMETS

All grommets are solid brass. Grommets are spaced evenly throughout the length of the header. 12" x 18" flags have #1 grommets and 16" x 24" and larger flags have #2 grommets.



#1 Flat Rimmed

#2 Rolled Rimmed with tooth washer

### CORNER PATCHES

10' x 15' and larger flags include a 2-ply corner patch sewn into each header corner.



### GROMMET REINFORCEMENT

8' x 12' and larger flags include a heavy-duty plastic reinforcement sleeve at each grommet location.

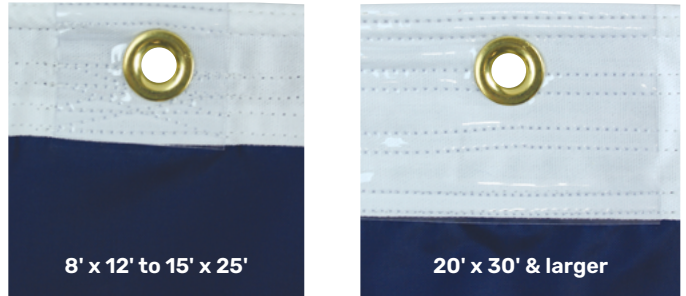

8' x 12' to 15' x 25'

20' x 30' & larger

## FLAG ETIQUETTE

### WHEN TO DISPLAY THE AMERICAN FLAG

The flag should be displayed on all days when weather permits, especially on legal holidays or other special occasions. It is customary to display the flag from sunrise to sunset on buildings or on stationary flagstaffs in the open. However, on special occasions it may be displayed at night, preferably lighted. In several places the flag flies day and night; among these are the Capitol in Washington, D.C., and the Fort Henry National Monument in Baltimore, which was the inspiration for "The Star Spangled Banner" by Francis Scott Key.

The flag should be displayed...

- on or near the main administration building of every public institution
- in or near polling places on election days
- in or near schools when they are in session

A citizen may fly the flag on any day they wish.



## FLY STITCHING REINFORCEMENTS

**3' x 5' – 5' x 9-1/2'**  
1" Double Fold

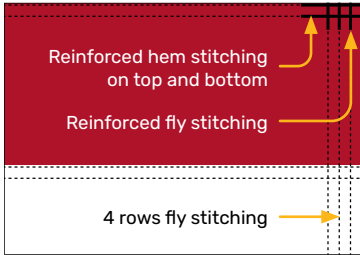

**6' x 10'**  
1-1/4" Double Fold

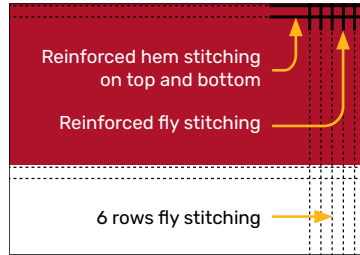

**8' x 12' – 12' x 18'**  
1-1/2" Double Fold

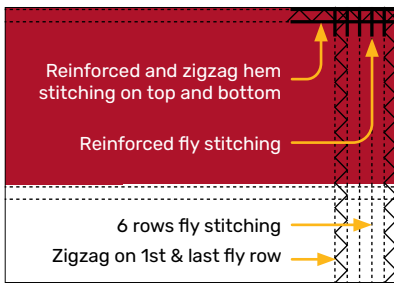

**15' x 25' – 20' x 38'**  
1-1/2" Double Fold

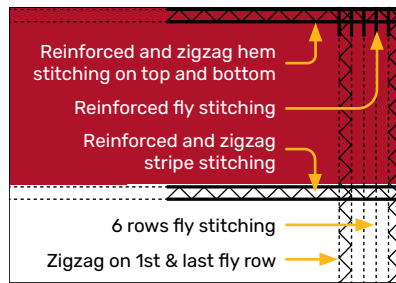

**25' x 40' & LARGER**  
2" Double Fold

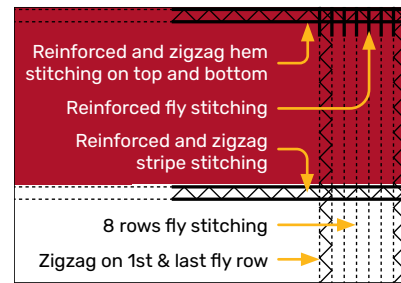

## VERTICAL STITCHING & REINFORCED CORNERS

Can be added to any flag in this catalog.

**Vertical Stitching & Reinforced Corners (shown on a 25' x 40' or larger flag).**

Yellow represents the extra vertical stitching and green represents the reinforced corners.

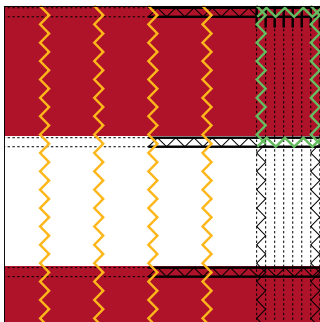

Size	Price	Size	Price
3' x 5'	\$25.50	15' x 25'	\$101.00
4' x 6'	28.00	20' x 30'	127.00
5' x 8'	33.00	20' x 38'	127.00
5' x 9-1/2'	33.00	25' x 40'	151.00
6' x 10'	42.00	30' x 50'	189.00
8' x 12'	53.00	30' x 60'	189.00
10' x 15'	77.00	40' x 70'	405.00
10' x 19'	77.00	40' x 75'	405.00
12' x 18'	88.00	50' x 80'	505.00

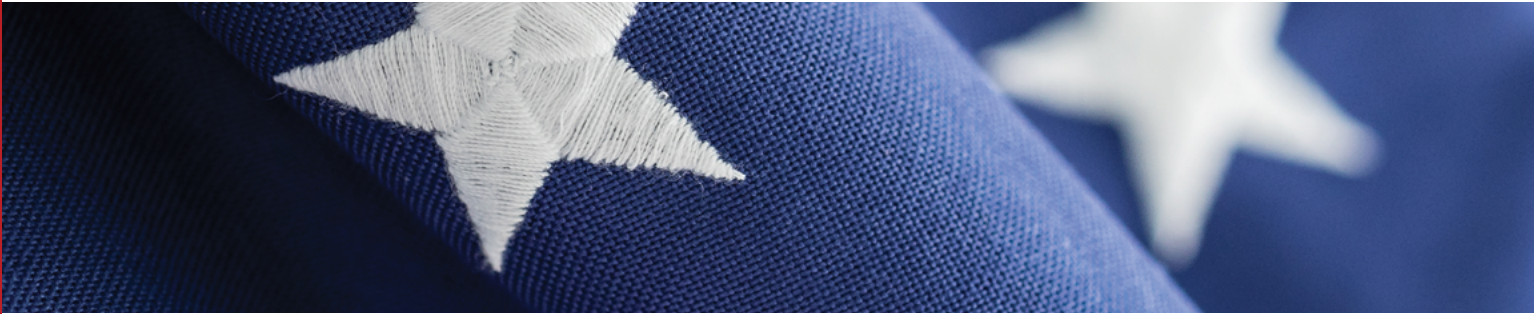

### POLY-MAX™ U.S. FLAGS

Our Poly-Max Flags are crafted using 2-ply 100% polyester bunting. The open weave construction reduces wind resistance, increasing flag life. Poly-Max material is extremely durable and ideal for commercial applications and high wind areas. Finished with white poly-cotton header. See [page 7](#) for additional flag specifications.

\* The PF80 and PF80-VS are not intended to be used on a flagpole. This size in polyester would be for display purposes only.

Model	Item #	Size	1-5	6-11	12+	Lbs.	Qty/Case
PF5	010045	3' x 5'	\$68.20	\$59.10	\$56.30	.95	25
PF6	010046	4' x 6'	95.50	83.40	79.00	1.4	15
PF8	010047	5' x 8'	151.00	130.40	123.00	2.2	10
PF9	010048	5' x 9-1/2'	177.00	162.00	149.00	2.8	10
PF10	010049	6' x 10'	229.00	199.00	184.00	3.2	6
PF12	010050	8' x 12'	334.00	328.00	312.00	5.1	3
PF15	010051	10' x 15'	511.00	507.00	480.00	7.6	2
PF19	010052	10' x 19'	600.00	586.00	554.00	9.0	2
PF18	010053	12' x 18'	697.00	683.00	652.00	11	1
PF25	010054	15' x 25'	1,250.00	1,220.00	1,180.00	18	1
PF30	010055	20' x 30'	1,920.00	1,880.00	1,800.00	32	1
PF38	010056	20' x 38'	2,170.00	2,140.00	2,080.00	38	1
PF40	010057	25' x 40'	2,910.00	2,850.00	2,820.00	50	1
PF50	010058	30' x 50'	4,410.00	4,310.00	4,150.00	82	1
PF60	010059	30' x 60'	5,150.00	4,930.00	4,670.00	92	1
PF70	010292	40' x 70'	12,970.00	12,640.00	12,260.00	143	1
PF75	010294	40' x 75'	13,690.00	13,330.00	13,000.00	153	1
PF80*	010298	50' x 80'	14,260.00	13,910.00	13,550.00	204	1

### WITH VERTICAL STITCHING & REINFORCED CORNERS

Includes ADDITIONAL zigzag stitching reinforcement: 4 vertical rows on fly end and zigzag stitching on fly end corners. See [illustration on page 9](#).

Model	Item #	Size	1-5	6-11	12+	Lbs.	Qty/Case
PF5-VS	010061	3' x 5'	\$93.70	\$84.60	\$81.80	.95	25
PF6-VS	010062	4' x 6'	123.50	111.40	107.00	1.4	15
PF8-VS	010063	5' x 8'	184.00	163.40	156.00	2.2	10
PF9-VS	010064	5' x 9-1/2'	210.00	195.00	182.00	2.8	10
PF10-VS	010065	6' x 10'	271.00	241.00	226.00	3.2	6
PF12-VS	010066	8' x 12'	387.00	381.00	365.00	5.1	3
PF15-VS	010067	10' x 15'	588.00	584.00	557.00	7.6	2
PF19-VS	010068	10' x 19'	677.00	663.00	631.00	9.0	2
PF18-VS	010069	12' x 18'	785.00	771.00	740.00	11	1
PF25-VS	010070	15' x 25'	1,350.00	1,320.00	1,290.00	18	1
PF30-VS	010071	20' x 30'	2,040.00	2,010.00	1,930.00	32	1
PF38-VS	010072	20' x 38'	2,300.00	2,270.00	2,210.00	38	1
PF40-VS	010073	25' x 40'	3,070.00	3,000.00	2,970.00	50	1
PF50-VS	010074	30' x 50'	4,600.00	4,490.00	4,340.00	82	1
PF60-VS	010075	30' x 60'	5,340.00	5,120.00	4,850.00	92	1
PF70-VS	010293	40' x 70'	13,360.00	13,030.00	12,650.00	143	1
PF75-VS	010295	40' x 75'	14,080.00	13,720.00	13,390.00	153	1
PF80-VS*	010301	50' x 80'	14,750.00	14,400.00	14,040.00	204	1

## ENDURA-NYLON™ U.S. FLAGS

Our Endura-Nylon flags are crafted using aniline-dyed 100% heavyweight 200-denier nylon bunting. Endura-Nylon material is fast drying, treated to resist fading and flies in the slightest breeze. Finished with white poly-cotton header. See [page 7](#) for additional flag specifications.

\* The NF80 and NF80-VS are not intended to be used on a flagpole. This size in nylon would be for display purposes only.

Model	Item #	Size	1-5	6-11	12+	Lbs.	Qty/Case
NF3	010003	2' x 3'	33.50	30.40	27.70	.30	70
NF4	010004	2-1/2' x 4'	39.10	36.70	34.70	.45	50
NF5	010005	3' x 5'	55.30	49.60	44.90	.60	40
NF6	010006	4' x 6'	68.00	63.30	58.70	.85	25
NF8	010007	5' x 8'	106.50	98.80	90.80	1.3	20
NF9	010008	5' x 9-1/2'	134.90	113.10	108.00	1.5	15
NF10	010009	6' x 10'	149.00	144.00	133.00	1.9	12
NF12	010010	8' x 12'	277.00	269.00	246.00	3.1	8
NF15	010011	10' x 15'	405.00	402.00	385.00	4.4	5
NF19	010012	10' x 19'	454.00	449.00	434.00	5.5	3
NF18	010013	12' x 18'	542.00	540.00	525.00	6.5	3
NF25	010014	15' x 25'	960.00	940.00	880.00	11	2
NF30	010015	20' x 30'	1,290.00	1,230.00	1,110.00	17	1
NF38	010016	20' x 38'	1,490.00	1,430.00	1,290.00	20	1
NF40	010017	25' x 40'	2,090.00	2,080.00	2,070.00	34	1
NF50	010018	30' x 50'	2,940.00	2,930.00	2,770.00	44	1
NF60	010019	30' x 60'	3,480.00	3,380.00	3,140.00	54	1
NF80*	010297	50' x 80'	12,440.00	11,760.00	10,580.00	119	1

## WITH VERTICAL STITCHING & REINFORCED CORNERS

Includes ADDITIONAL zigzag stitching reinforcement: 4 vertical rows on fly end and zigzag stitching on fly end corners.

See illustration on [page 9](#).

Model	Item #	Size	1-5	6-11	12+	Lbs.	Qty/Case
NF5-VS	010025	3' x 5'	\$80.80	\$75.10	\$70.40	.60	40
NF6-VS	010026	4' x 6'	96.00	91.30	86.70	.85	25
NF8-VS	010027	5' x 8'	139.50	131.80	123.80	1.3	20
NF9-VS	010028	5' x 9-1/2'	167.90	146.10	141.00	1.5	15
NF10-VS	010029	6' x 10'	191.00	186.00	175.00	1.9	12
NF12-VS	010030	8' x 12'	330.00	322.00	299.00	3.1	8
NF15-VS	010031	10' x 15'	482.00	479.00	462.00	4.4	5
NF19-VS	010032	10' x 19'	531.00	526.00	511.00	5.5	3
NF18-VS	010033	12' x 18'	630.00	628.00	613.00	6.5	3
NF25-VS	010034	15' x 25'	1,060.00	1,040.00	980.00	11	2
NF30-VS	010035	20' x 30'	1,410.00	1,350.00	1,240.00	17	1
NF38-VS	010036	20' x 38'	1,620.00	1,560.00	1,410.00	20	1
NF40-VS	010037	25' x 40'	2,240.00	2,230.00	2,220.00	34	1
NF50-VS	010038	30' x 50'	3,120.00	3,110.00	2,960.00	44	1
NF60-VS	010039	30' x 60'	3,670.00	3,570.00	3,330.00	54	1
NF80-VS*	010305	50' x 80'	12,930.00	12,250.00	11,070.00	119	1

## MODIFIED U.S. FLAGS

Welcome to the premier collection of Modified & Stadium Size American Flags, where unmatched craftsmanship meets monumental scale. Whether you're outfitting a grand arena, hosting a major event, or making a powerful patriotic statement, our flags are designed to command attention and inspire pride.

Explore our exclusive line of top- and framed-header American flags, expertly modified for secure, high-visibility hanging in expansive indoor or outdoor spaces. Ideal for stadiums, auditoriums, and large-scale ceremonies, these flags are built to perform and impress.

*Need something even bigger?* Our Stadium Flags with Handles – available in sizes up to 150' x 300' – deliver breathtaking impact for sporting events, arenas, and national celebrations. **These flags are 100% made in the USA.**



## MODIFIED U.S. FLAG CONSTRUCTION SPECIFICATIONS

Flag Size	Stars	Grommet Reinforcement	Header Width	Top Header	Framed Header	Invisible Header	Double Rope		
				Number of Grommets			Header Width	Number of Grommets	Corner Patches
8' x 12'	Embroidered	Yes	1-1/2"	4	10	6	2"	2	–
10' x 15'	Embroidered	Yes	1-1/2"	5	14	7	2"	2	Yes, ALL
10' x 19'	Embroidered	Yes	1-1/2"	7	18	9	2"	2	Yes, ALL
12' x 18'	Embroidered	Yes	1-1/2"	6	16	8	2"	2	Yes, ALL
15' x 25'	Appliqued	Yes	1-1/2"	6	16	8	2"	6	Yes, ALL
20' x 30'	Appliqued	Yes	2"	6	16	8	3" doubled	6	Yes, ALL
20' x 38'	Appliqued	Yes	2"	8	20	10	3" doubled	6	Yes, ALL
25' x 40'	Appliqued	Yes	2"	8	22	10	3" doubled	10	Yes, ALL
30' x 50'	Appliqued	Yes	2"	10	28	12	3" doubled	14	Yes, ALL
30' x 60'	Appliqued	Yes	2"	12	32	14	3" doubled	14	Yes, ALL

FLAG ETIQUETTE

### AMERICAN FLAG DISPLAY GUIDELINES

#### PROCESSIONS & GROUP DISPLAYS

- When carried in procession with other flags, the U.S. Flag should lead: positioned at the right-front of the column or, if in a line, at the center front.
- The flag must never be carried flat or horizontally—it should always be held aloft and free.
- When grouped with other flags on staffs, the U.S. Flag belongs in the center or at the highest point.
- When crossed with another flag, the U.S. Flag should be on its own right, with its staff in front.

#### DISPLAY FROM BUILDINGS

- When flown from a staff projecting from a window, balcony, or building front, the union should be at the peak (unless flown at half-staff).
- When displayed flat—indoors or outdoors—the union must be positioned uppermost and to the flag's own right (the observer's left).
- In windows, the union should also be to the observer's left.

#### STREET & SIDEWALK DISPLAYS

- When hung over the middle of a street, display the flag vertically: union to the north on east-west streets, and to the east on north-south streets.
- When suspended over a sidewalk from a rope extending from a building to a pole, hoist the flag outward from the building, union first.

#### PLATFORMS, PULPITS & AUDITORIUMS

- On a speaker's platform, the U.S. Flag may be displayed flat behind the speaker or flown from a staff on the speaker's right; other flags go to the speaker's left.
- In churches, the flag should be on a staff to the clergyman's right as he faces the congregation; other flags to his left.
- When displayed on the floor of a church or auditorium, place the flag to the audience's right.

#### MULTIPLE FLAGS & HALYARDS

- When flown with state, city, or organizational flags on the same halyard, the U.S. Flag must always be at the peak.
- When flown on adjacent staffs, it should be raised first and lowered last.

#### CASKET DISPLAY

- When used on a casket, position the union at the head and over the left shoulder.
- The flag should not touch the ground or be lowered into the grave.
- The casket is carried foot-first from the hearse to the grave.

## MODIFIED U.S. FLAG CONSTRUCTION OPTIONS

### TOP HEADER

The grommets are spaced evenly across the top header only. The quantity is determined by the flag size.

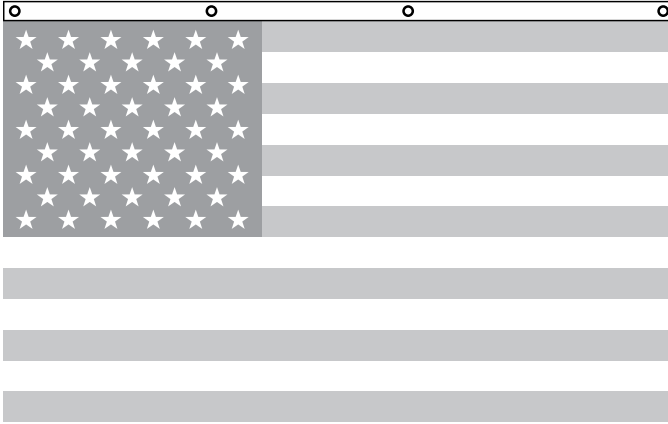

### FRAMED HEADER

The grommets are spaced evenly on all four header sides. The quantity on the top and bottom headers is the same as that of a top-header flag of the same size. The remaining grommets are spaced evenly along the left and right headers.

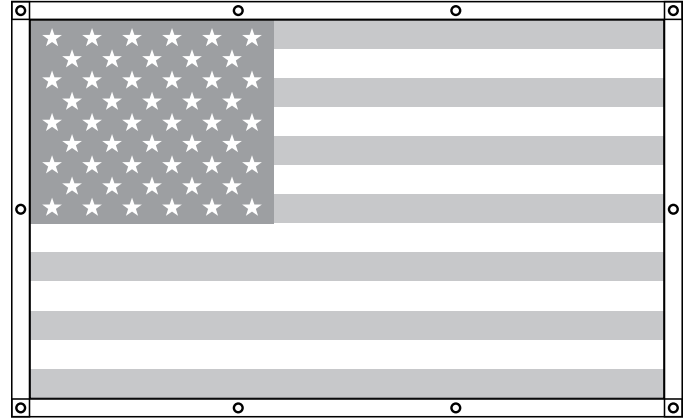

### POLY-MAX™ U.S. FLAGS

Model	Item #	Size	1-5	6-11	12+	Lbs.	Qty/ Case
PF12	010348-T	8' x 12'	\$396	\$385	\$369	5.1	3
PF15	010349-T	10' x 15'	574	557	534	7.6	2
PF19	010350-T	10' x 19'	664	645	618	9	2
PF18	010351-T	12' x 18'	760	738	707	11	1
PF25	010352-T	15' x 25'	1,310	1,271	1,219	18	1
PF30	010353-T	20' x 30'	1,978	1,919	1,840	32	1
PF38	010354-T	20' x 38'	2,236	2,169	2,080	38	1
PF40	010355-T	25' x 40'	2,978	2,889	2,770	50	1
PF50	010356-T	30' x 50'	4,472	4,338	4,159	82	1
PF60	010357-T	30' x 60'	5,212	5,056	4,848	92	1

### POLY-MAX™ U.S. FLAGS

Model	Item #	Size	1-5	6-11	12+	Lbs.	Qty/ Case
PF12	010348-F	8' x 12'	\$458	\$445	\$426	5.5	3
PF15	010349-F	10' x 15'	636	617	592	8	2
PF19	010350-F	10' x 19'	726	705	676	9.4	2
PF18	010351-F	12' x 18'	822	798	765	11.4	1
PF25	010352-F	15' x 25'	1,370	1,329	1,275	18.5	1
PF30	010353-F	20' x 30'	2,040	1,979	1,898	32.5	1
PF38	010354-F	20' x 38'	2,298	2,230	2,138	38.5	1
PF40	010355-F	25' x 40'	3,040	2,949	2,828	50.6	1
PF50	010356-F	30' x 50'	4,532	4,397	4,215	82.6	1
PF60	010357-F	30' x 60'	5,274	5,116	4,905	92.6	1

### ENDURA-NYLON™ U.S. FLAGS

Model	Item #	Size	1-5	6-11	12+	Lbs.	Qty/ Case
NF12	010338-T	8' x 12'	\$340	\$330	\$317	3.1	8
NF15	010339-T	10' x 15'	468	454	436	4.4	5
NF19	010340-T	10' x 19'	518	503	482	5.5	3
NF18	010341-T	12' x 18'	604	586	562	6.5	3
NF25	010342-T	15' x 25'	1,020	990	949	11	2
NF30	010343-T	20' x 30'	1,350	1,310	1,256	17	1
NF38	010344-T	20' x 38'	1,556	1,510	1,448	20	1
NF40	010345-T	25' x 40'	2,154	2,090	2,004	34	1
NF50	010346-T	30' x 50'	2,998	2,909	2,789	44	1
NF60	010347-T	30' x 60'	3,544	3,438	3,296	54	1

### ENDURA-NYLON™ U.S. FLAGS

Model	Item #	Size	1-5	6-11	12+	Lbs.	Qty/ Case
NF12	010338-F	8' x 12'	\$402	\$390	\$374	3.5	8
NF15	010339-F	10' x 15'	530	515	493	4.8	5
NF19	010340-F	10' x 19'	578	561	538	5.9	3
NF18	010341-F	12' x 18'	666	647	620	6.9	3
NF25	010342-F	15' x 25'	1,082	1,050	1,007	11.5	2
NF30	010343-F	20' x 30'	1,412	1,370	1,314	17.5	1
NF38	010344-F	20' x 38'	1,618	1,570	1,505	20.5	1
NF40	010345-F	25' x 40'	2,216	2,150	2,061	34.6	1
NF50	010346-F	30' x 50'	3,060	2,969	2,846	44.6	1
NF60	010347-F	30' x 60'	3,606	3,498	3,354	54.6	1

**INVISIBLE HEADER**

The grommets are spaced evenly across the top header. The quantity is determined by the flag size. Additional grommets are placed in the lower left and right corners.

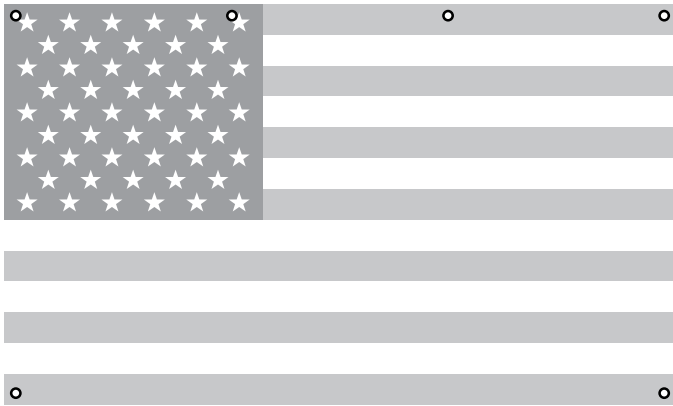

**DOUBLE ROPE**

Rope headers with steel thimbles are attached to the left and right sides of the flag. Grommets are spaced evenly along the headers. The quantity is determined by the flag size.

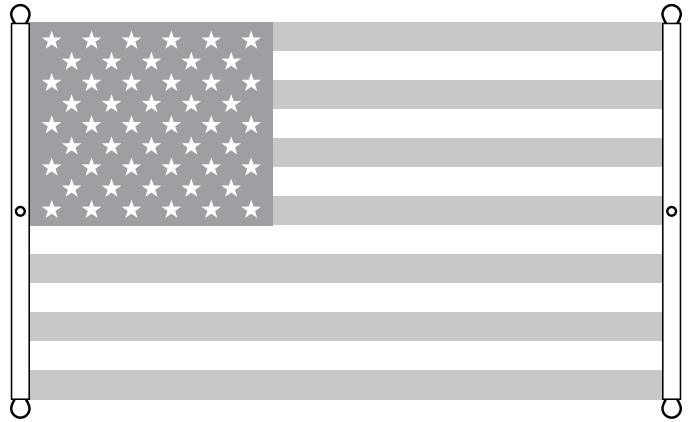

**POLY-MAX™ U.S. FLAGS**

Model	Item #	Size	1-5	6-11	12+	Lbs.	Qty/ Case
PF12	010348-I	8' x 12'	\$620	\$602	\$577	5.5	3
PF15	010349-I	10' x 15'	798	775	743	8	2
PF19	010350-I	10' x 19'	888	862	826	9.4	2
PF18	010351-I	12' x 18'	984	955	916	11.4	1
PF25	010352-I	15' x 25'	1,534	1,488	1,427	18.5	1
PF30	010353-I	20' x 30'	2,242	2,175	2,086	32.5	1
PF38	010354-I	20' x 38'	2,500	2,425	2,325	38.5	1
PF40	010355-I	25' x 40'	3,242	3,145	3,016	50.6	1
PF50	010356-I	30' x 50'	4,736	4,594	4,405	82.6	1
PF60	010357-I	30' x 60'	5,476	5,312	5,093	92.6	1

**POLY-MAX™ U.S. FLAGS**

Model	Item #	Size	1-5	6-11	12+	Lbs.	Qty/ Case
PF12	010348-D	8' x 12'	\$540	\$524	\$503	6	3
PF15	010349-D	10' x 15'	718	697	668	8.5	2
PF19	010350-D	10' x 19'	808	784	752	9.6	2
PF18	010351-D	12' x 18'	904	877	841	12	1
PF25	010352-D	15' x 25'	1,454	1,411	1,353	19	1
PF30	010353-D	20' x 30'	2,122	2,059	1,974	32.8	1
PF38	010354-D	20' x 38'	2,380	2,309	2,214	38.8	1
PF40	010355-D	25' x 40'	3,122	3,029	2,904	50.8	1
PF50	010356-D	30' x 50'	4,616	4,478	4,293	82.9	1
PF60	010357-D	30' x 60'	5,356	5,196	4,982	92.9	1

**ENDURA-NYLON™ U.S. FLAGS**

Model	Item #	Size	1-5	6-11	12+	Lbs.	Qty/ Case
NF12	010338-I	8' x 12'	\$512	\$497	\$477	3.5	8
NF15	010339-I	10' x 15'	640	621	596	4.8	5
NF19	010340-I	10' x 19'	690	670	642	5.9	3
NF18	010341-I	12' x 18'	778	755	724	6.9	3
NF25	010342-I	15' x 25'	1,194	1,159	1,111	11.5	2
NF30	010343-I	20' x 30'	1,614	1,566	1,502	17.5	1
NF38	010344-I	20' x 38'	1,820	1,766	1,693	20.5	1
NF40	010345-I	25' x 40'	2,418	2,346	2,249	34.6	1
NF50	010346-I	30' x 50'	3,262	3,165	3,034	44.6	1
NF60	010347-I	30' x 60'	3,808	3,694	3,542	54.6	1

**ENDURA-NYLON™ U.S. FLAGS**

Model	Item #	Size	1-5	6-11	12+	Lbs.	Qty/ Case
NF12	010338-D	8' x 12'	\$432	\$420	\$402	4	8
NF15	010339-D	10' x 15'	560	544	521	5	5
NF19	010340-D	10' x 19'	610	592	568	6	3
NF18	010341-D	12' x 18'	698	678	650	7	3
NF25	010342-D	15' x 25'	1,114	1,081	1,037	12	2
NF30	010343-D	20' x 30'	1,494	1,450	1,390	18	1
NF38	010344-D	20' x 38'	1,700	1,649	1,581	21	1
NF40	010345-D	25' x 40'	2,298	2,230	2,138	35	1
NF50	010346-D	30' x 50'	3,142	3,048	2,923	45	1
NF60	010347-D	30' x 60'	3,688	3,578	3,430	55	1



### 3' X 5' ENDURA-NYLON II U.S. OUTDOOR FLAGS

**With Embroidered Stars, Sewn Stripes and Chain-Stitching**

Identical to Endura-Nylon Flag Item #010005, except the stripes are chain-stitched instead of lock-stitched. See [Stitching on page 7](#).

Item #	1-5	6-11	12+	Lbs.	Qty/Case
010262	\$41.90	\$40.10	\$35.50	.60	40



### ENDURA-NYLON U.S. OUTDOOR BANNER FLAGS

**Embroidered Stars And Sewn Stripes**

These flags can replace any decorative flag or banner. Finished with white pole sleeve and leather tab.

Item #	Size	1-5	6-11	12-35	36+	Lbs.
010041	3' x 5'	\$62.60	\$57.00	\$50.70	\$47.10	.60



### ENDURA-PC™ U.S. OUTDOOR FLAG

This fully printed poly-cotton flag has the look and feel of a cotton flag with the advantages of a polyester flag. Double-stitched fly ends and canvas header with brass grommets.

Item #	Size	1-23	24-71	72-143	144+	Lbs.
010125	3' x 5'	\$23.70	\$17.50	\$16.80	\$16.20	.40

## ENDURA-TEX™ COTTON U.S. OUTDOOR FLAGS

### Embroidered Stars and Sewn Stripes

Our Endura-Tex™ U.S. Flags are carefully manufactured using traditional heavyweight 2x2 ply mercerized cotton bunting. Extra rugged weave meets U.S. Government specifications and the most modern dyeing techniques ensure brilliant colors that are fast to sun and rain.

Model	Item #	Size	1-5	6-11	12+	Lbs.
CF5	010078	3' x 5'	\$60.20	\$58.70	\$55.50	.85
CF9	010081	5' x 9-1/2'	156.00	150.00	147.00	2.3

### FLY ENDS

**3' x 5' & 5' x 9-1/2'**  
1" Double Fold

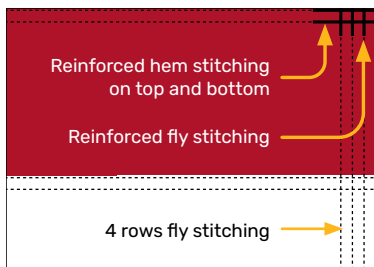

### HEADERS

**HEADER:** 1-1/2" heavy-duty, bright white cotton polyester blend army duck cloth.

**GROMMETS:** Two solid brass #2 rolled rimmed with tooth washer grommets.



## SUN-BRITE™ NYLON U.S. FLAGS

These flags are ideal for residential or commercial applications. Sun-Brite™ Flags are fully printed on SolarMax nylon using our aniline dyeing process.

Item #	Size	1-5	6-11	12-35	36+	Lbs.
010093	12" x 18"	\$16.00	\$15.00	\$14.60	\$13.00	.07
010096	2' x 3'	39.10	38.20	37.70	37.20	.21
010259	4' x 6'	87.00	—	—	—	.70
010260	5' x 8'	125.00	—	—	—	1.0



### HEADERS

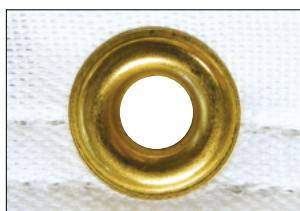

**12" x 18"**  
**HEADER:** 1" heavy-duty, bright white cotton polyester blend army duck cloth.

**GROMMETS:** Two solid brass #1 flat rimmed grommets.

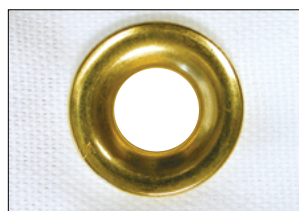

**16" x 24" – 5' x 8'**  
**HEADER:** 1-1/2" heavy-duty, bright white cotton polyester blend army duck cloth.

**GROMMETS:** Two solid brass #2 rolled rimmed with tooth washer grommets.

### FLY ENDS

**12" x 18"**  
3/8" Double Fold

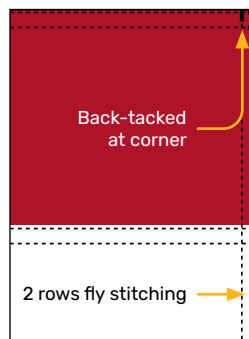

**16" x 24" – 5' x 8'**  
1" Double Fold

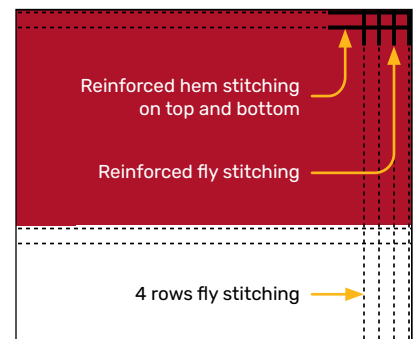



ECONOMY FLAG SET PARTS



DELUXE FLAG SET PARTS

**3' X 5' OUTDOOR FLAG MOUNTING SETS ONLY**

- No Flag
- Individually poly-bagged

Type	Pole Size	Pole Material	Plastic Eagle	Stamped Steel Bracket	Flag Mountings
Economy	6' X 3/4" 3-Piece	Silver Steel	Gold	Silver	Nylon Flag Ties
Deluxe	6' X 3/4" 3-Piece	Gold Aluminum	Brass Plated	Gold	EZ-Mount Flag Rings

Item #	Hardware	1-23	24-71	72-143	144+	Lbs.
010160	Economy	\$13.60	\$12.70	\$12.10	\$11.40	1.0
010162	Deluxe	26.00	25.00	24.50	24.00	.90

**REPLACEMENT PARTS FOR FLAG SETS**

**PLASTIC SLIP FIT EAGLES**

See [page 56](#) for more slip fit eagles.

**Brass Plated**

For Pole	Ht.	Wing Span	Lbs.	Item #	Price
3/4" Aluminum	3-1/4"	4-1/4"	.05	050031	\$5.18
3/4" Steel	3-1/4"	4-1/4"	.05	050032	5.18

**Gold Gilt**

For Pole	Ht.	Wing Span	Lbs.	Item #	Price
3/4" Steel	3-1/4"	4-1/4"	.05	050035	\$1.78

**CLEAR PLASTIC EZ-MOUNT FLAG RING**

- See [page 104](#) for more EZ-Mount flag rings
- Priced per ring

Item #	Model	For Pole Dia.	1-71	72-143	144+	Lbs.
310104	EZ-34	3/4"	\$1.64	\$1.38	\$1.30	.02

**STAMPED STEEL BRACKET**

See [page 101](#) for more stamped steel brackets.

Item #	Color	For Pole Dia.	1-71	72-143	144+	Lbs.
310061	Gold	3/4"	\$5.28	\$4.26	\$4.08	.20

**NYLON FLAG TIE**

See [page 104](#) for more nylon flag ties.

Item #	Model	Max. Pole Dia.	1-71	72-143	144+	Lbs.
310110	NFT4	3/4"	\$0.52	\$0.40	\$0.32	.001



### SPINNING POLE FLAG SETS

With your choice of 6' silver or white aluminum pole

- Flag made in USA
- Pole keeps flag unfurled
- Bracket adjusts to 13 different positions including vertical and horizontal
- 3' x 5' Endura-Nylon II U.S. Outdoor Flag. [See page 16.](#)
- 6' Aluminum Anti-Furl Rotating Pole with ball ornament and EZ-Mount flag rings. [See page 106.](#)
- Aluminum Ultimate Adjustable Bracket with mounting screws. [See page 100.](#)

Item #	Finish	1-11	12-23	24+	Lbs.
010334	Silver Pole/ Silver Ball	\$94.00	\$90.00	\$84.50	3.8
010335	White Pole/ Gold Ball	91.50	87.00	82.50	3.8

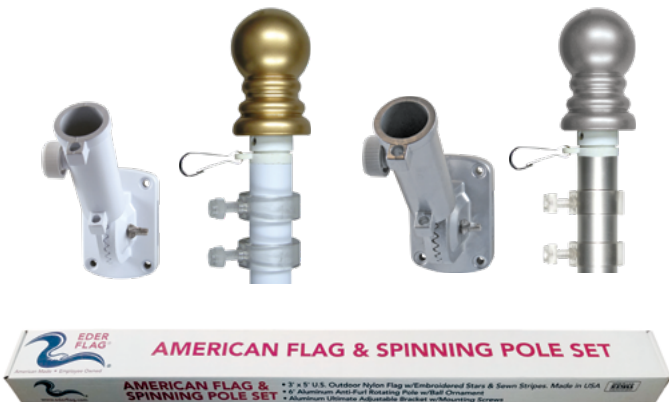

### REGAL FLAG SETS

With your choice of 6' white or black fiberglass pole

- NeverFurl Flag unfurler. [See page 105.](#)
- Solid brass acorn ornament. [See page 58.](#)
- Solid brass mounting bracket with mounting screws. [See page 102.](#)
- 6' fiberglass pole. [See page 108.](#)

### COMPLETE SETS WITH 6' POLE & 3' X 5' NYLON U.S. FLAG

Item #	Pole	1-11	12-23	24+	Lbs.
010275	1" White	\$168.00	\$162.00	\$156.00	4.7
010277	1" Black	168.00	162.00	156.00	4.7

### COMPLETE SETS WITH 6' POLE (NO FLAG)

Item #	Pole	1-11	12-23	24+	Lbs.
010276	1" White	\$126.00	\$117.00	\$112.00	4.1
010278	1" Black	126.00	117.00	112.00	4.1



### BLACK NYLON MOURNING STREAMERS

Item #	Size	Style	Price	Lbs.
070481	2" x 5'	Single	\$16.80	.02
070482	2" x 5'	Double	20.50	.03

## DELUXE U.S. NYLON INDOOR/PARADE FLAG SETS

**ALL SETS INCLUDE:**

- Brass plated metal eagle ornament
- Gold cord & tassel
- 2-piece pole with brass screw joint
- Gold anodized Endura floor stand.

All complete sets also include a U.S. Nylon Flag with embroidered stars and sewn stripes, pole hem, leather tabs and gold fringe.



Perched Eagle



Endura™ Stand



Oak Pole



Gold Aluminum Pole



Cord & Tassel



**With Gold Aluminum Poles**

Item #	Model	Type	Flag Size	Pole Size	Eagle Type	Eagle Ht.	Eagle Wing Span	Stand Dia.	Price	Lbs.
010166	FA-301	Complete Set	3' x 5'	8' x 1-1/8"	Perched	6-3/4"	7-1/2"	12"	\$320.00	20
010302	FA-301MS	Mounting Set Only	—	8' x 1-1/8"	Perched	6-3/4"	7-1/2"	12"	235.00	19
010168	FA-46	Complete Set	4' x 6'	9' x 1-1/8"	Perched	6-3/4"	7-1/2"	12"	370.00	22
010169	FA-303	Complete Set	5' x 8'	11' x 1-1/8"	Perched	6-3/4"	7-1/2"	12"	460.00	22

**With Oak Poles**

Item #	Model	Type	Flag Size	Pole Size	Eagle Type	Eagle Ht.	Eagle Wing Span	Stand Dia.	Price	Lbs.
010170	F-300	Complete Set	2' x 3'	7' x 15/16"	Perched	5"	5"	9"	\$271.00	13
010172	FW-301	Complete Set	3' x 5'	8' x 1-1/8"	Perched	6-3/4"	7-1/2"	12"	330.00	22
010303	FW-301MS	Mounting Set Only	—	8' x 1-1/8"	Perched	6-3/4"	7-1/2"	12"	238.00	21
010174	FW-46	Complete Set	4' x 6'	9' x 1-1/8"	Perched	6-3/4"	7-1/2"	12"	360.00	23



**FREEDOM FLAG SET**

- Hi-impact, shiny gold plated ABS styrene perched eagle ornament
- 3' x 5' Nylon U.S. Flag with embroidered stars, sewn stripes, pole hem and gold fringe
- Gold cord & tassel
- 8' X 1-1/4" oak pole with precision machined brass screw joint
- 12" Diameter shiny gold plated plastic regent floor stand

Item #	Model	Eagle Height	Wing Span	Price		Lbs.
				1-5	6+	
010289	FFS-35	7"	7-1/2"	\$296.00	\$281.00	15



Oak Pole



Regent Stand



Gold Perched Eagle



Cord & Tassel

**U.S. NYLON INDOOR/PARADE FLAGS**

Complete with embroidered stars and sewn stripes, pole hem and leather tabs.

**With Gold Fringe**

Item #	Model	Size	Price	Lbs.
010175	FN-5	2' x 3'	\$78.30	.45
010177	FN-3	3' x 5'	92.10	.80
010179	FN-46	4' x 6'	135.20	1.1
010180	FN-7	5' x 8'	210.00	1.7

**Without Fringe**

Item #	Model	Size	Price	Lbs.
010181	FNH-5	2' x 3'	\$61.60	.35
010183	FNH-3	3' x 5'	68.00	.65
010185	FNH-46	4' x 6'	88.10	.90
010186	FNH-7	5' x 8'	175.00	1.3

**INDOOR/PARADE MOUNTING SET**

Complete with a brass plated eagle ornament (5" high with 5" wing span), gold cord & tassel, EZ-Mount flag rings, 2-piece 8' x 1" gold anodized aluminum pole with top adapter, and 12" diameter gold Viscount floor stand.

**Complete Set**

Item #	Price	Lbs.
010270	\$188.00	5.9

**Pole Only**

Pole includes 2 EZ-Mount flag rings

Item #	1-11	12+	Lbs.
050534	\$72.00	\$68.50	1.2



Perched Eagle



Cord & Tassel



Viscount Stand



EZ-Mount Flag Rings



Gold Aluminum Pole with Ornament Adapter

**FLAG SPREADER**

For 1" to 1-1/4" Outside Diameter Poles

The Spreader has a vinyl coated bracket pole attachment and sure-grip flag clips that hold the flag securely in place.

Item #	1-5	6+	Lbs.
050542	\$37.50	\$34.00	.45

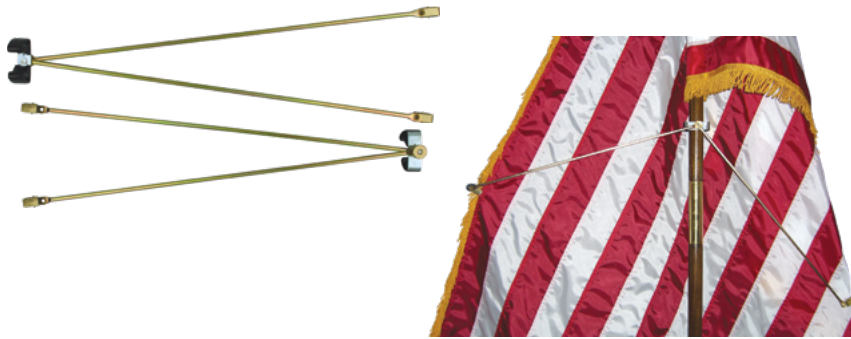

**INDOOR MOUNTING SETS (NO FLAG)**

- 8' x 1-1/4" oak pole with precision machined brass screw joint
- 12" diameter shiny gold plated plastic Regent floor stand
- Gold cord & tassel
- Choice of either a shiny gold plated ABS styrene eagle or spear ornament

Item #	Description	Price	Lbs.
050549	With Eagle	\$222.00	14
050550	With Spear	219.00	14



**ENDURA-GLOSS™ U.S. MOUNTED FLAGS**

Beautifully printed on silk-like material, these flags offer the highest quality in a hand-held, desk or classroom flag. Hem stitched on all four sides for longer lasting beauty. Comes complete with a gold spear.

Item #	Flag Size	Staff Size	Staff Material	Staff Color	1-143	144+	Lbs.
010196	8" x 12"	1/4" x 18"	Wood	Black	\$4.82	\$4.60	.05



**LIGHTWEIGHT POLY-COTTON U.S. MOUNTED FLAGS**

Printed on soft poly-cotton sheeting and hemmed on all four sides. All sizes come complete with a gold spear.

Item #	Flag Size	Staff Size	Staff Material	Staff Color	1-11	12-143	144-1439	1440+	Lbs.
010230	8" x 12"	5/16" x 24"	Wood	Natural	\$2.26	\$2.18	\$2.14	\$2.08	.07
010231	12" x 18"	3/8" x 30"	Wood	Natural	3.82	3.66	3.54	3.28	.13



12" x 18"

**PLASTIC U.S. MOUNTED FLAGS**

3-1/2 mil virgin plastic. Mounted with a pole sleeve. Comes complete with a gold spear.

Item #	Flag Size	Staff Size	Staff Material	Staff Color	1-11	12-143	144-1439	1440+	Lbs.
010247	4" x 6"	3/16" x 10"	Plastic	Gold	\$0.68	\$0.60	\$0.54	\$0.50	.02

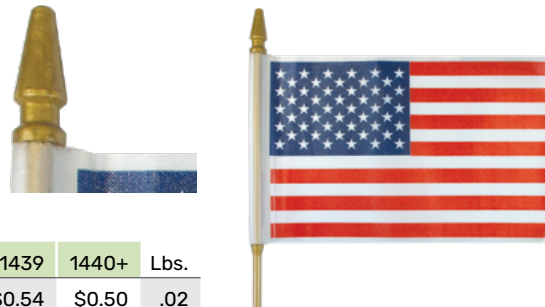

**NO-FRAY POLY-COTTON FLAGS WITH GOLD SPEAR**

Item #	Flag Size	Staff Size	Staff Material	Staff Color	1-11	12-143	144-1439	1440+	Lbs.
010205	4" x 6"	3/16" x 10"	Wood	Natural	\$0.76	\$0.72	\$0.68	\$0.64	.02
010286	8" x 12"	5/16" x 24"	Wood	Natural	1.68	1.62	1.50	1.36	.05
010208	12" x 18"	5/16" x 30"	Wood	Natural	2.60	2.42	2.28	2.16	.10

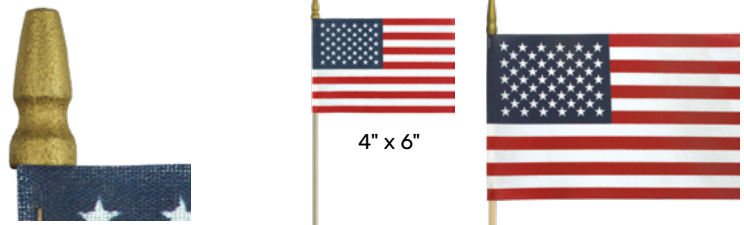

4" x 6"

8" x 12"  
#010286

# U.S. FLAGS

MOUNTED

## NO-FRAY POLY-COTTON FLAGS WITH GOLD BALL



Item #	Flag Size	Staff Size	Material	Staff Color	1-11	12-143	144-1439	1440+	Lbs.
010213	4" x 6"	3/16" x 10"	Wood	Natural	\$0.84	\$0.82	\$0.76	\$0.74	.02

## NO-FRAY POLY-COTTON FLAGS NO TIP

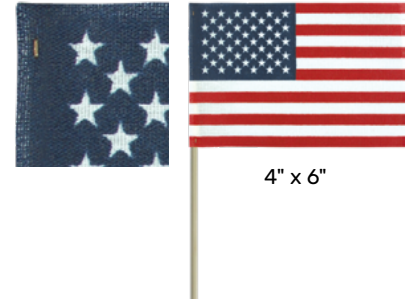

Item #	Flag Size	Staff Size	Material	Staff Color	1-11	12-143	144-1439	1440+	Lbs.
010221	4" x 6"	3/16" x 10"	Wood	Natural	\$0.60	\$0.54	\$0.52	\$0.48	.02
010223	8" x 12"	5/16" x 24"	Wood	Natural	1.66	1.62	1.42	1.28	.05
010224	12" x 18"	5/16" x 30"	Wood	Natural	2.52	2.32	2.18	2.04	.10

## U.S. AUTO WINDOW FLAG

Comes complete with 11-1/2" x 14" U.S. polyester flag. Complete set supplied with 1-piece plastic bracket. Bracket only is a 2-piece plastic bracket.

**Custom flag designs are also available.**



Item #	Description	1-23	24-71	72-143	144+	Lbs.
010252	Complete Set	\$21.20	\$20.90	\$19.40	\$18.50	.30
010253	2-Piece Bracket Only	10.80	9.90	9.10	8.70	.25

## COTTON PLEATED FANS FULLY PRINTED

Size	Item #	No Stars - Fully Printed			With Stars - Fully Printed			
		1-11	12+	Lbs.	Item #	1-11	12+	Lbs.
18" x 36"	-	-	-	-	160064	\$22.10	\$19.10	.30
3' x 6'	160007	\$46.80	\$37.90	.75	160009	48.20	39.00	.80



## 3' X 3' PLEATED HALF FANS FULLY SEWN, NO STARS

Item #	Material	1-11	12+	Lbs.
160025	Nylon	\$70.10	\$65.40	.95



## NYLON PLEATED FANS FULLY SEWN, NO STARS

Size	Model	Item #	1-11	12+	Lbs.
16" x 32"	-	160011	\$40.10	\$37.30	.30
27" x 54"	NFAN-1	160012	57.80	52.90	.60
3' x 6'	NFAN-2	160013	65.90	60.90	.80
4' x 8'	NFAN-3	160014	96.00	90.00	1.8
5' x 10'	NFAN-4	160015	149.10	136.90	3.2

All fans come with Canvas Header & Brass Grommets

FANS, DECORATIONS & BUNTING



**ENDURA-POLY™ PLEATED FANS**  
FULLY PRINTED

Style	Item #	Size	1-11	12+	Lbs.
Americana	160004	3' x 6'	\$40.80	\$37.70	.55



**POLY-COTTON ILLUSION FANS**

Uniquely printed giving the effect of a traditional fully pleated fan.

Item #	Size	1-71	72+	Lbs.
160063	18" x 36"	\$15.70	\$12.80	.20

**NYLON U.S. PULLDOWNS**  
EMBROIDERED STARS - SEWN STRIPES

With canvas header and brass grommets

Item #	Size	1-11	12+	Lbs.
160045	20" x 8'	\$36.20	\$33.30	.55
160046	20" x 10'	40.10	37.30	.60
160047	20" x 12'	43.70	40.50	.65



160045

**18" X 48" U.S. ECONOMY PULLDOWNS**

FULLY PRINTED

- With canvas header and brass grommets
- Poly-cotton

Item #	1-11	12+	Lbs.
160054	\$27.20	\$24.00	.20



**COTTON RED, WHITE & BLUE BUNTING**

Order a minimum of **5 YARDS** and quantity in **5 YARD** increments only. You may receive a seam.

Item #	Desc.	Stripes	Stars	Width	Lbs.	5-65 Yards	70+ Yards
160058	Fully Printed	5	—	36"	.20	\$9.60	\$8.10
160059	Fully Printed	5	Yes	36"	.20	9.90	8.30
160068	Fully Printed	5	Yes	18"	.10	5.60	4.80



160058



160059



160068

**NYLON RED, WHITE & BLUE BUNTING**

Order a minimum of **5 YARDS** and quantity in **5 YARD** increments only. You may receive a seam.

Item #	Desc.	Stripes	Stars	Width	Lbs.	5-65 Yards	70+ Yards
160060	Fully Sewn	5	—	36"	.25	\$31.00	\$29.50



**FLAG PATTERN BUNTING**

Cotton, hemmed on all four sides.

Item #	Pattern	Size	1-11	12+	Lbs.
160067	12" x 18"	12" x 25'	\$34.10	\$30.80	1.2



Our State flags are crafted in accordance with each state's official design specifications, ensuring accurate representation of their symbols and heritage.

The flags are produced using high-quality, durable materials designed to withstand the elements, making them suitable for both indoor and outdoor display.

The outdoor State flag selection has a unique pricing guide that assigns a state design into a pricing category, A-E. The pricing is located at the bottom of each page by size and pricing category.

See [page 4](#) for pricing add-ons for pole hem & fringe flags and pole hem only flags.



## COMPLETE 50 STATE FLAG SETS

### OUTDOOR FLAGS

Item #	Size	Material	Price	Lbs.
022048	2' x 3'	Nylon	\$1,480.00	13
022054	3' x 5'	Nylon	2,360.00	24
022060	4' x 6'	Nylon	4,470.00	36
022066	5' x 8'	Nylon	6,500.00	52
022072	6' x 10'	Nylon	10,550.00	86
022075	8' x 12'	Nylon	19,600.00	147

### INDOOR & PARADE FLAGS WITH POLE HEM

Item #	Size	Material	Price	Lbs.
022049	2' x 3'	Nylon	\$2,330.00	11
022055	3' x 5'	Nylon	3,440.00	21
022061	4' x 6'	Nylon	5,670.00	33
022067	5' x 8'	Nylon	7,980.00	47
022073	6' x 10'	Nylon	12,500.00	79

### INDOOR & PARADE FLAGS WITH POLE HEM & FRINGE

Item #	Size	Material	Price	Lbs.
022050	2' x 3'	Nylon	\$3,180.00	16
022056	3' x 5'	Nylon	4,510.00	39
022062	4' x 6'	Nylon	6,870.00	48
022068	5' x 8'	Nylon	9,550.00	62
022074	6' x 10'	Nylon	14,500.00	97



# STATE & TERRITORY FLAGS



		ALABAMA		ALASKA		ARIZONA		ARKANSAS		CALIFORNIA		
PRICE CATEGORY		A		A		E		A		A		
		Item #	Lbs.	Item #	Lbs.	Item #	Lbs.	Item #	Lbs.	Item #	Lbs.	
SIZE & MATERIAL	12" x 18"	Nylon	020004	.10	—	—	—	—	020115	.10	—	—
	2' x 3'	Nylon	020005	.25	020042	.25	020079	.25	020116	.25	020153	.25
	3' x 5'	Nylon	020007	.45	020044	.45	020081	.45	020118	.45	020155	.45
	4' x 6'	Nylon	020009	.70	020046	.70	020083	.70	020120	.70	020157	.70
	5' x 8'	Nylon	020011	1.0	020048	1.0	020085	1.0	020122	1.0	020159	1.0
	6' x 10'	Nylon	020013	1.6	020050	1.8	020087	1.8	020124	1.7	020161	1.6
	8' x 12'	Nylon	020014	2.9	020051	3.0	020088	2.6	020125	2.9	020162	3.0
	10' x 15'	Nylon	022113	5.8	022114	4.8	022115	4.4	022116	4.7	022117	4.7
	12' x 18"	Nylon	020010	6.5	020052	6.8	020089	5.9	020126	6.6	020163	6.7
	3' x 5'	Poly-Max	022197	.65	022198	.65	022199	.65	022200	.65	022201	.65
	4' x 6'	Poly-Max	022249	.95	022250	.95	022251	.95	022252	.95	022253	.95
	5' x 8'	Poly-Max	022301	1.5	022302	1.5	022303	1.5	022304	1.5	022305	1.5



		COLORADO		CONNECTICUT		DELAWARE		FLORIDA		GEORGIA		
PRICE CATEGORY		A		C		D		D		A		
		Item #	Lbs.	Item #	Lbs.	Item #	Lbs.	Item #	Lbs.	Item #	Lbs.	
SIZE & MATERIAL	12" x 18"	Nylon	—	—	020226	.10	020263	.10	—	—	022173	.10
	2' x 3'	Nylon	020190	.25	020227	.25	020264	.25	020301	.25	022174	.25
	3' x 5'	Nylon	020192	.45	020229	.45	020266	.45	020303	.45	022176	.45
	4' x 6'	Nylon	020194	.70	020231	.70	020268	.70	020305	.70	022177	.70
	5' x 8'	Nylon	020196	1.0	020233	1.0	020270	1.0	020307	1.0	022178	1.0
	6' x 10'	Nylon	020198	2.7	020235	1.7	020272	1.7	020309	1.8	022179	1.7
	8' x 12'	Nylon	020199	4.1	020236	2.9	020273	2.9	020310	3.0	022180	2.9
	10' x 15'	Nylon	022118	5.8	022119	4.7	022120	4.6	022121	4.7	022196	4.4
	12' x 18"	Nylon	020200	9.2	020237	6.6	020274	6.5	020311	6.7	—	—
	3' x 5'	Poly-Max	022202	.65	022203	.65	022204	.65	022205	.65	022206	.65
	4' x 6'	Poly-Max	022254	.95	022255	.95	022256	.95	022257	.95	022258	.95
	5' x 8'	Poly-Max	022306	1.5	022307	1.5	022308	1.5	022309	1.5	022310	1.5

## STATE OUTDOOR FLAG PRICE GUIDE

PRICE CATEGORY		A - STATES		B - STATES		C - STATES		D - STATES		E - STATES		
QUANTITY		1-11	12+	1-11	12+	1-11	12+	1-11	12+	1-11	12+	
SIZE & MATERIAL	12" x 18"	Nylon	\$14.50	\$13.10	\$14.50	\$13.10	\$14.50	\$13.10	\$14.50	\$13.10	\$14.50	\$13.10
	2' x 3'	Nylon	32.40	29.10	48.50	43.70	32.40	29.10	32.40	29.10	32.40	29.10
	3' x 5'	Nylon	50.60	45.70	85.60	76.90	50.60	45.70	50.60	45.70	50.60	45.70
	4' x 6'	Nylon	85.50	82.00	121.50	116.00	93.00	88.50	101.50	96.00	101.50	96.00
	5' x 8'	Nylon	119.50	113.50	181.50	172.00	134.50	127.50	155.50	147.00	155.50	147.00
	6' x 10'	Nylon	214.00	192.00	279.00	253.00	226.00	202.00	250.00	226.00	401.00	362.00
	8' x 12'	Nylon	426.00	385.00	451.00	412.00	433.00	392.00	437.00	394.00	602.00	543.00
	10' x 15'	Nylon	530.00	504.00	630.00	597.00	545.00	519.00	625.00	585.00	700.00	656.00
	12' x 18"	Nylon	644.00	611.00	837.00	796.00	644.00	611.00	837.00	796.00	1290.00	1228.00
	3' x 5'	Poly-Max	91.90	88.80	204.50	185.30	101.40	98.30	105.20	102.30	105.20	102.30
	4' x 6'	Poly-Max	136.00	132.00	278.50	272.00	143.50	141.00	147.00	142.50	147.00	142.00
	5' x 8'	Poly-Max	210.50	206.50	400.00	393.00	215.00	210.50	220.00	215.00	220.00	215.00

# STATE & TERRITORY FLAGS

Quantity discounts apply to the same flag & size on pages 26-52.

STATE OUTDOOR FLAGS

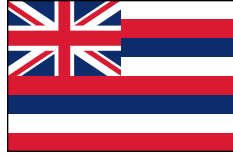

		HAWAII		IDAHO		ILLINOIS		INDIANA		IOWA		
PRICE CATEGORY		A		D		D		A		A		
		Item #	Lbs.	Item #	Lbs.	Item #	Lbs.	Item #	Lbs.	Item #	Lbs.	
SIZE & MATERIAL	12" x 18"	Nylon	—	—	020411	.10	020448	.10	—	—	020522	.10
	2' x 3'	Nylon	020375	.25	020412	.25	020449	.25	020486	.25	020523	.25
	3' x 5'	Nylon	020377	.45	020414	.45	020451	.45	020488	.45	020525	.45
	4' x 6'	Nylon	020379	.70	020416	.70	020453	.70	020490	.70	020527	.70
	5' x 8'	Nylon	020381	1.0	020418	1.0	020455	1.0	020492	1.0	020529	1.0
	6' x 10'	Nylon	020383	1.8	020420	1.7	020457	1.7	020494	1.6	020531	1.7
	8' x 12'	Nylon	020384	3.1	020421	2.7	020458	2.7	020495	2.8	020532	2.7
	10' x 15'	Nylon	022123	4.9	022124	4.5	022125	4.4	022126	4.5	022127	4.4
	12' x 18'	Nylon	020385	7.0	020422	6.1	020459	6.0	020496	6.2	020533	6.0
	3' x 5'	Poly-Max	022207	.65	022208	.65	022209	.65	022210	.65	022211	.65
	4' x 6'	Poly-Max	022259	.95	022260	.95	022261	.95	022262	.95	022263	.95
	5' x 8'	Poly-Max	022311	1.5	022312	1.5	022313	1.5	022314	1.5	022315	1.5



		KANSAS		KENTUCKY		LOUISIANA		MAINE		MARYLAND		
PRICE CATEGORY		D		D		C		D		C		
		Item #	Lbs.	Item #	Lbs.	Item #	Lbs.	Item #	Lbs.	Item #	Lbs.	
SIZE & MATERIAL	12" x 18"	Nylon	020559	.10	020596	.10	020633	.10	—	—	—	—
	2' x 3'	Nylon	020560	.25	020597	.25	022424	.25	020671	.25	020708	.25
	3' x 5'	Nylon	020562	.45	020599	.45	020636	.45	020673	.45	020710	.45
	4' x 6'	Nylon	020564	.70	020601	.70	020638	.70	020675	.70	020712	.70
	5' x 8'	Nylon	020566	1.0	020603	1.0	020640	1.0	020677	1.0	020714	1.0
	6' x 10'	Nylon	020568	1.7	020605	1.7	020642	1.7	020679	1.7	020716	1.8
	8' x 12'	Nylon	020569	3.1	020606	2.9	020643	3.0	020680	2.9	020717	3.0
	10' x 15'	Nylon	022128	4.8	022129	4.7	022130	4.7	022131	4.7	—	—
	12' x 18'	Nylon	020570	6.9	020607	6.6	020644	6.7	020681	6.6	—	—
	3' x 5'	Poly-Max	022212	.65	022213	.65	022214	.65	022215	.65	022216	.65
	4' x 6'	Poly-Max	022264	.95	022265	.95	022266	.95	022267	.95	022268	.95
	5' x 8'	Poly-Max	022316	1.5	022317	1.5	022318	1.5	022319	1.5	022320	1.5

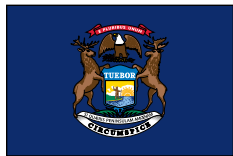

		MASSACHUSETTS		MICHIGAN		MINNESOTA		MISSISSIPPI		MISSOURI		
PRICE CATEGORY		A		D		C		C		C		
		Item #	Lbs.	Item #	Lbs.	Item #	Lbs.	Item #	Lbs.	Item #	Lbs.	
SIZE & MATERIAL	12" x 18"	Nylon	020744	.10	—	—	—	—	020855	.10	020892	.10
	2' x 3'	Nylon	020745	.25	020782	.25	022449	.25	020856	.25	020893	.25
	3' x 5'	Nylon	020747	.45	020784	.45	022450	.45	020858	.45	020895	.45
	4' x 6'	Nylon	020749	.70	020786	.70	022451	.70	020860	.70	020897	.70
	5' x 8'	Nylon	020751	1.0	020788	1.0	022452	1.0	020862	1.0	020899	1.0
	6' x 10'	Nylon	020753	1.7	020790	1.6	022467	1.6	020864	1.7	020901	1.7
	8' x 12'	Nylon	020754	2.9	020791	2.9	022468	2.9	020865	3.8	020902	3.0
	10' x 15'	Nylon	022132	4.7	022133	4.7	022469	4.7	022135	5.6	022136	4.7
	12' x 18'	Nylon	020755	6.6	020792	6.6	022470	6.6	—	—	020903	6.7
	3' x 5'	Poly-Max	022217	.65	022218	.65	022464	.65	022220	.65	022221	.65
	4' x 6'	Poly-Max	022269	.95	022270	.95	022465	.95	022272	.95	022273	.95
	5' x 8'	Poly-Max	022321	1.5	022322	1.5	022466	1.5	022324	1.5	022325	1.5

# STATE & TERRITORY FLAGS



		MONTANA		NEBRASKA		NEVADA		NEW HAMPSHIRE		NEW JERSEY		
PRICE CATEGORY		D		A		A		D		D		
		Item #	Lbs.	Item #	Lbs.	Item #	Lbs.	Item #	Lbs.	Item #	Lbs.	
SIZE & MATERIAL	12" x 18"	Nylon	020929	.10	020966	.10	021003	.10	021040	.10	021077	.10
	2' x 3'	Nylon	020930	.25	020967	.25	021004	.25	021041	.25	021078	.25
	3' x 5'	Nylon	020932	.45	020969	.45	021006	.45	021043	.45	021080	.45
	4' x 6'	Nylon	020934	.70	020971	.70	021008	.70	021045	.70	021082	.70
	5' x 8'	Nylon	020936	1.0	020973	1.0	021010	1.0	021047	1.0	021084	1.0
	6' x 10'	Nylon	020938	1.9	020975	1.8	021012	1.7	021049	1.5	021086	1.7
	8' x 12'	Nylon	020939	3.2	020976	3.2	021013	2.9	021050	3.0	021087	3.0
	10' x 15'	Nylon	022137	5.0	022138	5.0	022139	4.6	022140	4.7	022141	4.7
	12' x 18"	Nylon	020940	7.2	020977	7.2	021014	6.5	021051	6.7	021088	6.7
	3' x 5'	Poly-Max	022222	.65	022223	.65	022224	.65	022225	.65	022226	.65
	4' x 6'	Poly-Max	022274	.95	022275	.95	022276	.95	022277	.95	022278	.95
	5' x 8'	Poly-Max	022326	1.5	022327	1.5	022328	1.5	022329	1.5	022330	1.5



		NEW MEXICO		NEW YORK		NORTH CAROLINA		NORTH DAKOTA		OHIO		
PRICE CATEGORY		A		D		A		C		C		
		Item #	Lbs.	Item #	Lbs.	Item #	Lbs.	Item #	Lbs.	Item #	Lbs.	
SIZE & MATERIAL	12" x 18"	Nylon	—	—	—	—	—	—	—	021262	.10	
	2' x 3'	Nylon	021115	.25	021152	.25	021189	.25	021226	.25	021263	.25
	3' x 5'	Nylon	021117	.45	021154	.45	021191	.45	021228	.45	021265	.45
	4' x 6'	Nylon	021119	.70	021156	.70	021193	.70	021230	.70	021267	.70
	5' x 8'	Nylon	021121	1.0	021158	1.0	021195	1.0	021232	1.0	021269	1.0
	6' x 10'	Nylon	021123	1.8	021160	1.8	021197	1.5	021234	1.8	021271	1.8
	8' x 12'	Nylon	021124	3.1	021161	2.9	021198	2.7	021235	2.7	021272	2.7
	10' x 15'	Nylon	022142	4.9	022143	4.7	022144	4.5	022145	4.4	022146	4.4
	12' x 18"	Nylon	021125	7.0	021162	6.6	021199	6.1	021236	6.0	—	—
	3' x 5'	Poly-Max	022227	.65	022228	.65	022229	.65	022230	.65	022231	.65
	4' x 6'	Poly-Max	022279	.95	022280	.95	022281	.95	022282	.95	022283	.95
	5' x 8'	Poly-Max	022331	1.5	022332	1.5	022333	1.5	022334	1.5	022335	1.5

## STATE OUTDOOR FLAG PRICE GUIDE

PRICE CATEGORY		A - STATES		B - STATES		C - STATES		D - STATES		E - STATES		
QUANTITY		1-11	12+	1-11	12+	1-11	12+	1-11	12+	1-11	12+	
SIZE & MATERIAL	12" x 18"	Nylon	\$14.50	\$13.10	\$14.50	\$13.10	\$14.50	\$13.10	\$14.50	\$13.10	\$14.50	\$13.10
	2' x 3'	Nylon	32.40	29.10	48.50	43.70	32.40	29.10	32.40	29.10	32.40	29.10
	3' x 5'	Nylon	50.60	45.70	85.60	76.90	50.60	45.70	50.60	45.70	50.60	45.70
	4' x 6'	Nylon	85.50	82.00	121.50	116.00	93.00	88.50	101.50	96.00	101.50	96.00
	5' x 8'	Nylon	119.50	113.50	181.50	172.00	134.50	127.50	155.50	147.00	155.50	147.00
	6' x 10'	Nylon	214.00	192.00	279.00	253.00	226.00	202.00	250.00	226.00	401.00	362.00
	8' x 12'	Nylon	426.00	385.00	451.00	412.00	433.00	392.00	437.00	394.00	602.00	543.00
	10' x 15'	Nylon	530.00	504.00	630.00	597.00	545.00	519.00	625.00	585.00	700.00	656.00
	12' x 18"	Nylon	644.00	611.00	837.00	796.00	644.00	611.00	837.00	796.00	1290.00	1228.00
	3' x 5'	Poly-Max	91.90	88.80	204.50	185.30	101.40	98.30	105.20	102.30	105.20	102.30
	4' x 6'	Poly-Max	136.00	132.00	278.50	272.00	143.50	141.00	147.00	142.50	147.00	142.00
	5' x 8'	Poly-Max	210.50	206.50	400.00	393.00	215.00	210.50	220.00	215.00	220.00	215.00

# STATE & TERRITORY FLAGS

Quantity discounts apply to the same flag & size on pages 26-52.

STATE OUTDOOR FLAGS



		OKLAHOMA		OREGON		PENNSYLVANIA		RHODE ISLAND		SOUTH CAROLINA		
PRICE CATEGORY		C		B		D		A		A		
		Item #	Lbs.	Item #	Lbs.	Item #	Lbs.	Item #	Lbs.	Item #	Lbs.	
SIZE & MATERIAL	12" x 18"	Nylon	—	—	—	021373	.10	021410	.10	—	—	
	2' x 3'	Nylon	021300	.25	021337	.30	021374	.25	021411	.25	021448	.25
	3' x 5'	Nylon	021302	.45	021339	.60	021376	.45	021413	.45	021450	.45
	4' x 6'	Nylon	021304	.70	021341	1.0	021378	.70	021415	.70	021452	.70
	5' x 8'	Nylon	021306	1.0	021343	1.4	021380	1.0	021417	1.0	021454	1.0
	6' x 10'	Nylon	021308	1.6	021345	2.1	021382	1.7	021419	1.7	021456	1.7
	8' x 12'	Nylon	021309	3.0	021346	3.2	021383	2.6	021420	2.9	021457	2.8
	10' x 15'	Nylon	022147	4.8	022148	4.9	022149	4.4	022150	4.7	022151	4.6
	12' x 18'	Nylon	021310	6.8	021347	7.1	021384	5.9	021421	6.6	021458	6.3
	3' x 5'	Poly-Max	022232	.65	022233	.95	022234	.65	022235	.65	022236	.65
	4' x 6'	Poly-Max	022284	.95	022285	1.4	022286	.95	022287	.95	022288	.95
	5' x 8'	Poly-Max	022336	1.5	022337	2.3	022338	1.5	022339	1.5	022340	1.5

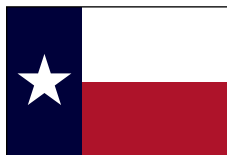

		SOUTH DAKOTA		TENNESSEE		TEXAS		UTAH*		VERMONT		
PRICE CATEGORY		C		A		(TX)		D		D		
		Item #	Lbs.	Item #	Lbs.			Item #	Lbs.	Item #	Lbs.	
SIZE & MATERIAL	12" x 18"	Nylon	021484	.10	021521	.10	SEE NEXT PAGE FOR TEXAS FLAGS		—	—	021637	.10
	2' x 3'	Nylon	021485	.25	021522	.25			022427	.25	021638	.25
	3' x 5'	Nylon	021487	.45	021524	.45			022428	.45	021640	.45
	4' x 6'	Nylon	021489	.70	021526	.70			022429	.70	021642	.70
	5' x 8'	Nylon	021491	1.0	021528	1.0			022430	1.0	021644	1.0
	6' x 10'	Nylon	021493	1.7	021530	2.3			022431	1.7	021646	1.8
	8' x 12'	Nylon	021494	2.9	021531	3.0			022432	2.7	021647	2.9
	10' x 15'	Nylon	022152	4.6	022153	4.8			022434	4.4	022156	4.7
	12' x 18'	Nylon	021495	6.5	021532	6.8			022433	6.0	021648	6.6
	3' x 5'	Poly-Max	022237	.65	022238	.65			022461	.65	022241	.65
	4' x 6'	Poly-Max	022289	.95	022290	.95			022462	.95	022293	.95
	5' x 8'	Poly-Max	022341	1.5	022342	1.5			022463	1.5	022345	1.5

\* The previous version of the Utah flag design is still available. Email sales at [sales@ederflag.com](mailto:sales@ederflag.com) or call 1-800-558-6044 for ordering information.



		VIRGINIA		WASHINGTON		WEST VIRGINIA		WISCONSIN		WYOMING		
PRICE CATEGORY		D		B		D		D		A		
		Item #	Lbs.	Item #	Lbs.	Item #	Lbs.	Item #	Lbs.	Item #	Lbs.	
SIZE & MATERIAL	12" x 18"	Nylon	—	—	—	021748	.10	021785	.10	021822	.10	
	2' x 3'	Nylon	021675	.25	021712	.30	021749	.25	021786	.25	021823	.25
	3' x 5'	Nylon	021677	.45	021714	.55	021751	.45	021788	.45	021825	.45
	4' x 6'	Nylon	021679	.70	021716	.80	021753	.70	021790	.70	021827	.70
	5' x 8'	Nylon	021681	1.0	021718	1.3	021755	1.0	021792	1.0	021829	1.0
	6' x 10'	Nylon	021683	1.6	021720	1.9	021757	1.7	021794	1.7	021831	1.7
	8' x 12'	Nylon	021684	2.8	021721	3.5	021758	3.2	021795	3.2	021832	3.0
	10' x 15'	Nylon	022157	4.5	022158	5.3	022159	4.9	022077	4.5	022160	4.9
	12' x 18'	Nylon	021685	6.2	021722	7.9	021759	7.1	021796	7.1	021833	6.8
	3' x 5'	Poly-Max	022242	.65	022243	.95	022244	.65	022245	.65	022246	.65
	4' x 6'	Poly-Max	022294	.95	022295	1.4	022296	.95	022297	.95	022298	.95
	5' x 8'	Poly-Max	022346	1.5	022347	2.3	022348	1.5	022349	1.5	022350	1.5

**MOUNTED**

Sold by the dozen

Item #	Size	Material	1-143	144+	Lbs.
021554	4" x 6"	Plastic	\$0.58	\$0.50	.02
021558	12" x 18"	Plastic	2.26	1.88	.10

**FULLY PRINTED OUTDOOR**

Item #	Size	Material	1-11	12+	Lbs.
021564	3' x 5'	Nylon	\$50.70	\$45.70	.45

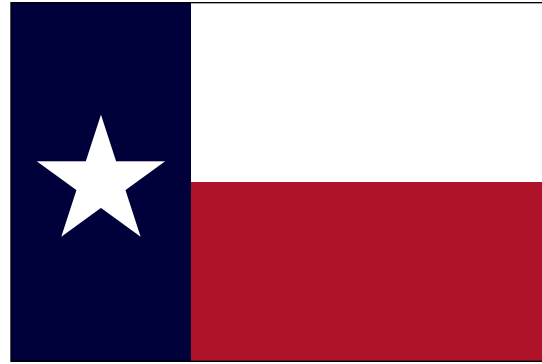

**FULLY SEWN OUTDOOR NYLON**

Item #	Size	1-11	12+	Lbs.
021562	2' x 3'	\$24.60	\$21.70	.35
021565	3' x 5'	38.80	35.50	.75
021567	4' x 6'	53.00	51.00	1.1
021569	5' x 8'	75.50	73.00	1.8
021571	6' x 10'	171.00	164.00	2.1
021572	8' x 12'	255.00	248.00	3.0
022076	10' x 15'	328.00	313.00	4.4
022418	10' x 19'	390.00	386.00	5.5
021573	12' x 18'	445.00	435.00	6.5
022356	15' x 25'	672.00	637.00	11
022415	20' x 30'	939.00	882.00	17
022357	20' x 38'	1,288.00	1,218.00	20
022437	25' x 40'	2,170.00	2,080.00	34
022420	30' x 50'	2,470.00	2,450.00	43
022422	30' x 60'	3,080.00	2,910.00	52

**FULLY SEWN OUTDOOR POLY-MAX**

Item #	Size	1-11	12+	Lbs.
022417	2' x 3'	\$43.70	\$40.60	.50
022239	3' x 5'	55.60	54.20	.75
022291	4' x 6'	78.50	75.00	.95
022343	5' x 8'	100.50	98.50	1.7
022358	6' x 10'	214.00	211.00	3.2
022359	8' x 12'	293.00	290.00	5.1
022360	10' x 15'	409.00	406.00	8.0
022419	10' x 19'	531.00	508.00	9.0
022361	12' x 18'	670.00	642.00	11
022362	15' x 25'	935.00	905.00	18
022416	20' x 30'	1,560.00	1,510.00	34
022363	20' x 38'	1,740.00	1,710.00	38
022438	25' x 40'	2,660.00	2,490.00	50
022421	30' x 50'	3,040.00	2,980.00	85
022423	30' x 60'	3,730.00	3,700.00	103

**FULLY SEWN OUTDOOR NYLON WITH VERTICAL STITCHING & REINFORCED CORNERS**



Item #	Size	1-11	12+	Lbs.
022435	3' x 5'	\$64.30	\$61.00	1
022436	4' x 6'	81.50	79.00	1.4
022473	5' x 8'	108.50	106.00	1.9
022475	6' x 10'	213.00	206.00	3.1
022474	8' x 12'	308.00	301.00	2.2
022476	10' x 15'	405.00	390.00	4.5
022477	12' x 18'	533.00	523.00	6.6
022478	15' x 25'	773.00	738.00	12
022479	20' x 30'	1,066.00	1009.00	18
022480	20' x 38'	1,415.00	1345.00	21
022481	25' x 40'	1,420.00	1350.00	36
022482	30' x 50'	2,660.00	2640.00	44
022483	30' x 60'	3,270.00	3100.00	53

**FULLY SEWN OUTDOOR POLY-MAX WITH VERTICAL STITCHING & REINFORCED CORNERS**



Item #	Size	1-11	12+	Lbs.
022484	3' x 5'	\$81.10	\$79.70	0.8
022485	4' x 6'	106.50	103.00	1
022486	5' x 8'	133.50	131.50	1.9
022487	6' x 10'	256.00	253.00	3.5
022488	8' x 12'	346.00	343.00	5.5
022489	10' x 15'	486.00	483.00	9
022490	12' x 18'	758.00	730.00	12
022491	15' x 25'	1,040.00	1,010.00	19
022492	20' x 30'	1,690.00	1,640.00	35
022493	20' x 38'	1,870.00	1,840.00	39
022494	25' x 40'	2,810.00	2,640.00	51
022495	30' x 50'	3,230.00	3,170.00	86
022496	30' x 60'	3,920.00	3,890.00	104

# STATE & TERRITORY FLAGS

Quantity discounts apply to the same flag & size on pages 26-52.



**AMERICAN SAMOA**



**GUAM**

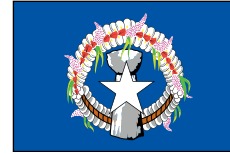

**NORTHERN MARIANAS**

SIZE & MATERIAL	AMERICAN SAMOA				GUAM				NORTHERN MARIANAS				
	Item #	1-11	12+	Lbs.	Item #	1-11	12+	Lbs.	Item #	1-11	12+	Lbs.	
12" x 18"	Nylon	—	—	—	021918	\$14.50	\$13.10	.10	—	—	—	—	
2' x 3'	Nylon	—	—	—	021919	66.10	59.50	.25	—	—	—	—	
3' x 5'	Nylon	021857	\$58.90	\$53.00	.45	021921	58.90	53.00	.45	022024	\$58.90	\$53.00	.45
4' x 6'	Nylon	021859	101.50	96.00	.70	021923	101.50	96.00	.70	022026	101.50	96.00	.70
5' x 8'	Nylon	021861	147.00	133.00	1.0	021925	192.00	173.00	1.0	035829	192.00	173.00	1.0
6' x 10'	Nylon	—	—	—	—	021927	250.00	226.00	1.8	—	—	—	—
8' x 12'	Nylon	—	—	—	—	021928	437.00	394.00	2.9	—	—	—	—



**PUERTO RICO**

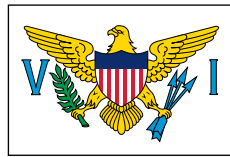

**VIRGIN ISLANDS**

SIZE & MATERIAL	PUERTO RICO				VIRGIN ISLANDS				
	Item #	1-11	12+	Lbs.	Item #	1-11	12+	Lbs.	
2' x 3'	Nylon	021955	\$32.40	\$29.10	.25	021991	\$32.40	\$29.10	.25
3' x 5'	Nylon	021957	58.90	53.00	.45	021993	58.90	53.00	.45
4' x 6'	Nylon	021959	85.50	82.00	.70	021995	101.50	96.00	.70
5' x 8'	Nylon	021961	119.50	113.50	1.0	021997	119.50	113.50	1.0
6' x 10'	Nylon	021963	214.00	192.00	1.7	021999	221.00	199.00	1.8
8' x 12'	Nylon	021964	426.00	385.00	3.2	022000	426.00	385.00	2.7
10' x 15'	Nylon	022163	530.00	504.00	4.9	—	—	—	—
3' x 5'	Poly-Max	022248	88.50	85.50	.65	—	—	—	—
4' x 6'	Poly-Max	022300	131.00	126.50	.95	—	—	—	—
5' x 8'	Poly-Max	022352	171.00	167.00	1.5	—	—	—	—



**CHICAGO**



**DISTRICT OF COLUMBIA**

SIZE & MATERIAL	CHICAGO				DISTRICT OF COLUMBIA				
	Item #	1-5	6+	Lbs.	Item #	1-11	12+	Lbs.	
12" x 18"	Nylon	—	—	—	021882	\$14.50	\$13.10	.10	
2' x 3'	Nylon	034923	\$54.40	\$49.20	.25	021883	32.40	29.10	.25
3' x 5'	Nylon	034925	82.50	74.00	.45	021885	58.90	53.00	.45
4' x 6'	Nylon	034926	120.50	108.00	.70	021887	85.50	82.00	.70
5' x 8'	Nylon	034927	193.00	184.00	1.0	021889	119.50	113.50	1.0
6' x 10'	Nylon	034928	309.00	-	1.8	021891	214.00	192.00	1.8
8' x 12'	Nylon	034929	417.00	-	3.1	021892	426.00	385.00	3.1
10' x 15'	Nylon	—	—	—	022161	530.00	504.00	4.8	
3' x 5'	E-Poly	034924	42.00	38.00	.27	—	—	—	—
3' x 5'	Poly-Max	—	—	—	022247	88.50	85.50	.65	
4' x 6'	Poly-Max	—	—	—	022299	131.00	126.50	.95	
5' x 8'	Poly-Max	—	—	—	022351	171.00	167.00	1.5	

TERRITORY OUTDOOR FLAGS

CHICAGO & DISTRICT OF COLUMBIA OUTDOOR FLAGS

## COMPLETE WORLD ORGANIZATION FLAG SETS

See [page 4](#) for pricing add-ons for pole hem & fringe flags and pole hem only flags.

### 35 MEMBER COMPLETE O.A.S. SETS



### OUTDOOR FLAGS

Item #	Size	Material	Description	Price	Lbs.
034648	2' x 3'	Nylon	Outdoor	\$1,500.00	8.8
034654	3' x 5'	Nylon	Outdoor	2,220.00	16
034657	4' x 6'	Nylon	Outdoor	3,210.00	25
034660	5' x 8'	Nylon	Outdoor	4,680.00	32

### INDOOR/PARADE FLAGS WITH POLE HEM

Item #	Size	Material	Description	Price	Lbs.
034649	2' x 3'	Nylon	with Pole Hem	\$2,100.00	7.1
034655	3' x 5'	Nylon	with Pole Hem	2,970.00	15
034658	4' x 6'	Nylon	with Pole Hem	4,050.00	23
034661	5' x 8'	Nylon	with Pole Hem	5,710.00	29

### INDOOR/PARADE FLAGS WITH POLE HEM & FRINGE

Item #	Size	Material	Description	Price	Lbs.
034650	2' x 3'	Nylon	with Pole Hem and Fringe	\$2,690.00	11
034656	3' x 5'	Nylon	with Pole Hem and Fringe	3,720.00	22
034659	4' x 6'	Nylon	with Pole Hem and Fringe	4,890.00	34
034662	5' x 8'	Nylon	with Pole Hem and Fringe	6,820.00	39

### 193 MEMBER COMPLETE U.N. SETS



### OUTDOOR FLAGS

Item #	Size	Material	Description	Price	Lbs.
034632	2' x 3'	Nylon	Outdoor	\$7,410.00	48
034635	3' x 5'	Nylon	Outdoor	10,990.00	86
034638	4' x 6'	Nylon	Outdoor	16,010.00	133
034641	5' x 8'	Nylon	Outdoor	23,710.00	171

### INDOOR/PARADE FLAGS WITH POLE HEM

Item #	Size	Material	Description	Price	Lbs.
034633	2' x 3'	Nylon	with Pole Hem	\$10,690.00	38
034636	3' x 5'	Nylon	with Pole Hem	15,140.00	76
034639	4' x 6'	Nylon	with Pole Hem	20,640.00	123
034642	5' x 8'	Nylon	with Pole Hem	29,400.00	152

### INDOOR/PARADE FLAGS WITH POLE HEM & FRINGE

Item #	Size	Material	Description	Price	Lbs.
034634	2' x 3'	Nylon	with Pole Hem and Fringe	\$13,970.00	57
034637	3' x 5'	Nylon	with Pole Hem and Fringe	19,290.00	114
034640	4' x 6'	Nylon	with Pole Hem and Fringe	25,270.00	180
034643	5' x 8'	Nylon	with Pole Hem and Fringe	35,480.00	209

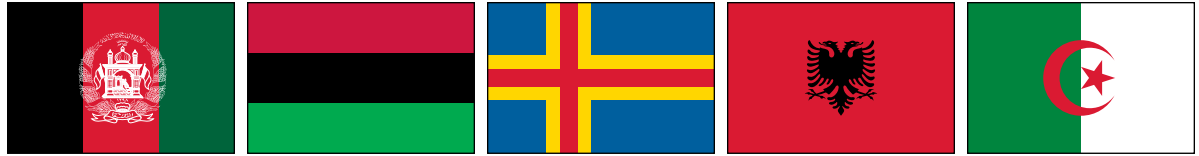

		AFGHANISTAN (UN)		AFRO-AMERICAN		ÅLAND ISLANDS		ALBANIA (UN)		ALGERIA (UN)		
PRICE CATEGORY		D		A		F		D		D		
		Item #	Lbs.	Item #	Lbs.	Item #	Lbs.	Item #	Lbs.	Item #	Lbs.	
SIZE & MATERIAL	2' x 3'	Nylon	030024	.25	030042	.25	-	-	030062	.25	030079	.25
	3' x 5'	Nylon	030026	.45	030044	.45	030058	.45	030064	.45	030081	.45
	4' x 6'	Nylon	030027	.70	030045	.70	-	-	030065	.70	030082	.70
	5' x 8'	Nylon	030028	1.0	030046	1.0	-	-	030066	1.0	030083	1.0
	6' x 10'	Nylon	035002	1.8	035003	1.8	-	-	035004	1.8	035005	1.8



		ANDORRA w/SEAL (UN)		ANDORRA (NO SEAL)		ANGOLA (UN)		ANGUILLA		ANTIGUA & BARBUDA (UN/OAS)		
PRICE CATEGORY		F		A		D		E		E		
		Item #	Lbs.	Item #	Lbs.	Item #	Lbs.	Item #	Lbs.	Item #	Lbs.	
SIZE & MATERIAL	12" x 18"	Nylon	-	-	-	-	-	-	035753	.10	035754	.10
	2' x 3'	Nylon	030096	.25	030113	.25	030126	.25	030143	.25	030164	.25
	3' x 5'	Nylon	030098	.45	030114	.45	030128	.45	030145	.45	030166	.45
	4' x 6'	Nylon	030099	.70	030115	.70	030129	.70	030146	.70	030167	.70
	5' x 8'	Nylon	030100	1.0	030116	1.0	030130	1.0	030147	1.0	030168	1.0
	6' x 10'	Nylon	035007	1.8	035006	1.8	035008	1.8	-	-	035010	1.8



		ARGENTINA w/SEAL (UN/OAS)		ARGENTINA (NO SEAL)		ARMENIA (UN)		ARUBA		AUSTRALIA (UN)		
PRICE CATEGORY		C		A		A		D		C		
		Item #	Lbs.	Item #	Lbs.	Item #	Lbs.	Item #	Lbs.	Item #	Lbs.	
SIZE & MATERIAL	12" x 18"	Nylon	-	-	-	-	-	-	030244	.10	-	-
	2' x 3'	Nylon	030188	.25	030207	.25	030223	.25	030245	.25	030266	.25
	3' x 5'	Nylon	030190	.45	030208	.45	030225	.45	030247	.45	030268	.45
	4' x 6'	Nylon	030191	.70	030209	.70	030226	.70	030248	.70	030269	.70
	5' x 8'	Nylon	030192	1.0	030210	1.0	030227	1.0	030249	1.0	030270	1.0
	6' x 10'	Nylon	035012	1.8	035011	1.8	035013	1.8	035014	1.8	035015	1.8
	3' x 5'	E-Poly	030189	.27	-	-	-	-	-	-	030267	.27

### FLAGS OF THE WORLD OUTDOOR PRICE GUIDE

PRICE CATEGORY		A - WORLD		B - WORLD		C - WORLD		D - WORLD		E - WORLD		F - WORLD		
QUANTITY		1-5	6+	1-5	6+	1-5	6+	1-5	6+	1-5	6+	1-5	6+	
SIZE & MATERIAL	12" x 18"	Nylon	\$16.10	\$14.40	\$17.00	\$15.60	\$18.80	\$17.00	\$20.70	\$18.60	\$20.70	\$18.60	\$20.70	\$18.60
	2' x 3'	Nylon	27.80	25.30	34.80	31.00	40.40	36.60	45.50	41.10	48.60	42.80	61.80	55.50
	3' x 5'	Nylon	37.50	33.50	55.50	50.50	64.00	56.50	65.00	58.50	74.50	67.50	85.50	76.00
	4' x 6'	Nylon	52.00	46.50	89.00	80.50	93.50	84.00	97.00	88.50	107.00	96.00	119.50	107.00
	5' x 8'	Nylon	80.00	77.00	115.00	111.00	130.00	125.00	132.00	126.00	151.00	146.00	161.00	150.00
	6' x 10'	Nylon	130.00	-	212.00	-	239.00	-	260.00	-	298.00	-	333.00	-
3' x 5'	E-Poly	30.00	26.50	30.00	26.50	30.00	26.50	30.00	26.50	30.00	26.50	30.00	26.50	



		AUSTRIA NO EAGLE (UN)		AUSTRIA w/EAGLE		AZERBAIJAN (UN)		BAHAMAS (UN/OAS)		BAHRAIN (UN)		
PRICE CATEGORY		A		F		E		D		C		
		Item #	Lbs.	Item #	Lbs.	Item #	Lbs.	Item #	Lbs.	Item #	Lbs.	
SIZE & MATERIAL	2' x 3'	Nylon	030295	.25	030313	.25	030329	.25	030355	.25	030374	.25
	3' x 5'	Nylon	030297	.45	030315	.45	030331	.45	030357	.45	030376	.45
	4' x 6'	Nylon	030298	.70	030316	.70	030332	.70	030358	.70	030377	.70
	5' x 8'	Nylon	030299	1.0	030317	1.0	030333	1.0	030359	1.0	030378	1.0
	6' x 10'	Nylon	035016	1.8	035017	1.8	035018	1.8	035019	1.8	035020	1.8

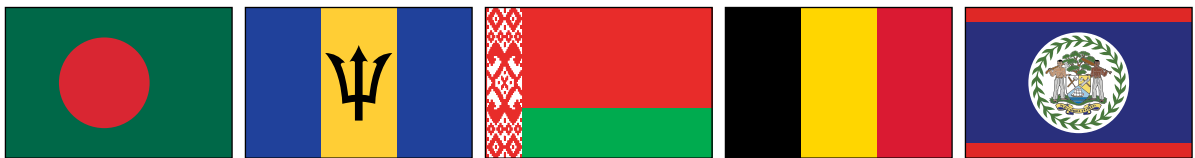

		BANGLADESH (UN)		BARBADOS (UN/OAS)		BELARUS (UN)		BELGIUM (UN)		BELIZE (UN/OAS)		
PRICE CATEGORY		D		D		D		A		F		
		Item #	Lbs.	Item #	Lbs.	Item #	Lbs.	Item #	Lbs.	Item #	Lbs.	
SIZE & MATERIAL	12" x 18"	Nylon	-	-	035755	.10	-	-	-	-	035756	.10
	2' x 3'	Nylon	030391	.25	030409	.25	030432	.25	030450	.25	030469	.25
	3' x 5'	Nylon	030393	.45	030411	.45	030433	.45	030452	.45	030471	.45
	4' x 6'	Nylon	030394	.70	030412	.70	030434	.70	030453	.70	030472	.70
	5' x 8'	Nylon	030395	1.0	030413	1.0	030435	1.0	030454	1.0	030473	1.0
	6' x 10'	Nylon	035021	1.8	035022	1.8	-	-	035025	1.8	035026	1.8
	3' x 5'	E-Poly	-	-	-	-	-	-	030451	.27	-	-

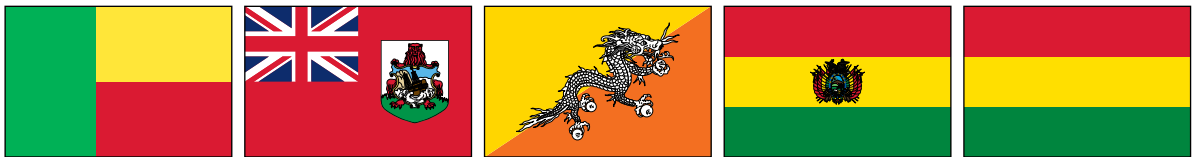

		BENIN (UN)		BERMUDA		BHUTAN (UN)		BOLIVIA w/SEAL (UN/OAS)		BOLIVIA (NO SEAL)		
PRICE CATEGORY		A		F		E		F		A		
		Item #	Lbs.	Item #	Lbs.	Item #	Lbs.	Item #	Lbs.	Item #	Lbs.	
SIZE & MATERIAL	2' x 3'	Nylon	030486	.25	030505	.25	030523	.25	030541	.25	030559	.25
	3' x 5'	Nylon	030488	.45	030507	.45	030525	.45	030543	.45	030560	.45
	4' x 6'	Nylon	030489	.70	030508	.70	030526	.70	030544	.70	030561	.70
	5' x 8'	Nylon	030490	1.0	030509	1.0	030527	1.0	030545	1.0	030562	1.0
	6' x 10'	Nylon	035027	1.8	035028	1.8	035029	1.8	035031	1.8	035030	1.8
	3' x 5'	E-Poly	-	-	-	-	-	-	030542	.27	-	-

FLAGS OF THE WORLD OUTDOOR PRICE GUIDE

PRICE CATEGORY		A - WORLD		B - WORLD		C - WORLD		D - WORLD		E - WORLD		F - WORLD		
QUANTITY		1-5	6+	1-5	6+	1-5	6+	1-5	6+	1-5	6+	1-5	6+	
SIZE & MATERIAL	12" x 18"	Nylon	\$16.10	\$14.40	\$17.00	\$15.60	\$18.80	\$17.00	\$20.70	\$18.60	\$20.70	\$18.60	\$20.70	\$18.60
	2' x 3'	Nylon	27.80	25.30	34.80	31.00	40.40	36.60	45.50	41.10	48.60	42.80	61.80	55.50
	3' x 5'	Nylon	37.50	33.50	55.50	50.50	64.00	56.50	65.00	58.50	74.50	67.50	85.50	76.00
	4' x 6'	Nylon	52.00	46.50	89.00	80.50	93.50	84.00	97.00	88.50	107.00	96.00	119.50	107.00
	5' x 8'	Nylon	80.00	77.00	115.00	111.00	130.00	125.00	132.00	126.00	151.00	146.00	161.00	150.00
	6' x 10'	Nylon	130.00	-	212.00	-	239.00	-	260.00	-	298.00	-	333.00	-
3' x 5'	E-Poly	30.00	26.50	30.00	26.50	30.00	26.50	30.00	26.50	30.00	26.50	30.00	26.50	



		BOSNIA & HERZEGOVINA (UN)		BOTSWANA (UN)		BRAZIL (UN/OAS)		BRITISH NAVY		BRITISH VIRGIN ISLANDS		
PRICE CATEGORY		E		A		D		C		F		
		Item #	Lbs.	Item #	Lbs.	Item #	Lbs.	Item #	Lbs.	Item #	Lbs.	
SIZE & MATERIAL	2' x 3'	Nylon	030572	.25	030577	.25	030601	.25	030622	.25	030635	.25
	3' x 5'	Nylon	030573	.45	030579	.45	030603	.45	030623	.45	030637	.45
	4' x 6'	Nylon	030574	.70	030580	.70	030604	.70	030624	.70	030638	.70
	5' x 8'	Nylon	030575	1.0	030581	1.0	030605	1.0	030625	1.0	030639	1.0
	6' x 10'	Nylon	035032	1.8	035033	1.8	035034	1.8	035035	1.8	035036	1.8
	3' x 5'	E-Poly	-	-	-	-	030602	.27	-	-	-	-



		BRUNEI (UN)		BULGARIA (UN)		BURKINA FASO (UN)		BURUNDI (UN)		CAMBODIA (UN)		
PRICE CATEGORY		E		A		B		E		E		
		Item #	Lbs.	Item #	Lbs.	Item #	Lbs.	Item #	Lbs.	Item #	Lbs.	
SIZE & MATERIAL	2' x 3'	Nylon	030652	.25	030670	.25	030684	.25	030701	.25	030718	.25
	3' x 5'	Nylon	030654	.45	030671	.45	030686	.45	030703	.45	030719	.45
	4' x 6'	Nylon	030655	.70	030672	.70	030687	.70	030704	.70	030720	.70
	5' x 8'	Nylon	030656	1.0	030673	1.0	030688	1.0	030705	1.0	030721	1.0
	6' x 10'	Nylon	035037	1.8	035038	1.8	035039	1.8	035040	1.8	035041	1.8

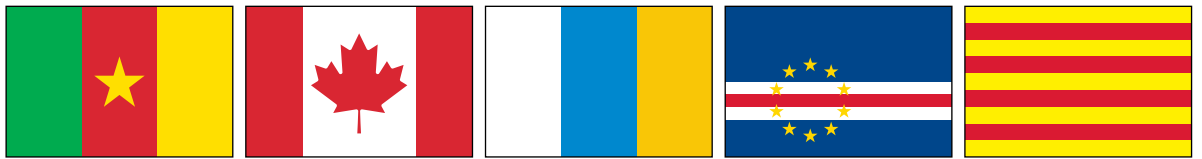

		CAMEROON (UN)		CANADA (UN/OAS)		CANARY ISLANDS		CAPE VERDE (UN)		CATALONIA		
PRICE CATEGORY		B		B		A		E		B		
		Item #	Lbs.	Item #	Lbs.	Item #	Lbs.	Item #	Lbs.	Item #	Lbs.	
SIZE & MATERIAL	2' x 3'	Nylon	030732	.25	030754	.25	030780	.25	030794	.25	030811	.25
	3' x 5'	Nylon	030734	.45	030756	.45	030781	.45	030796	.45	030813	.45
	4' x 6'	Nylon	030735	.70	030757	.70	030782	.70	030797	.70	030814	.70
	5' x 8'	Nylon	030736	1.0	030758	1.0	030783	1.0	030798	1.0	030815	1.0
	6' x 10'	Nylon	035042	1.8	035043	1.8	035044	1.8	035045	1.8	035046	1.8

FLAGS OF THE WORLD OUTDOOR PRICE GUIDE														
PRICE CATEGORY		A - WORLD		B - WORLD		C - WORLD		D - WORLD		E - WORLD		F - WORLD		
QUANTITY		1-5	6+	1-5	6+	1-5	6+	1-5	6+	1-5	6+	1-5	6+	
SIZE & MATERIAL	12" x 18"	Nylon	\$16.10	\$14.40	\$17.00	\$15.60	\$18.80	\$17.00	\$20.70	\$18.60	\$20.70	\$18.60	\$20.70	\$18.60
	2' x 3'	Nylon	27.80	25.30	34.80	31.00	40.40	36.60	45.50	41.10	48.60	42.80	61.80	55.50
	3' x 5'	Nylon	37.50	33.50	55.50	50.50	64.00	56.50	65.00	58.50	74.50	67.50	85.50	76.00
	4' x 6'	Nylon	52.00	46.50	89.00	80.50	93.50	84.00	97.00	88.50	107.00	96.00	119.50	107.00
	5' x 8'	Nylon	80.00	77.00	115.00	111.00	130.00	125.00	132.00	126.00	151.00	146.00	161.00	150.00
	6' x 10'	Nylon	130.00	-	212.00	-	239.00	-	260.00	-	298.00	-	333.00	-
3' x 5'	E-Poly	30.00	26.50	30.00	26.50	30.00	26.50	30.00	26.50	30.00	26.50	30.00	26.50	



		CAYMAN ISLANDS (BLUE)		CAYMAN ISLANDS (RED)		CENTRAL AFRICAN REPUBLIC (UN)		CHAD (UN)		CHILE (UN/OAS)		
PRICE CATEGORY		F		F		F		A		C		
		Item #	Lbs.	Item #	Lbs.	Item #	Lbs.	Item #	Lbs.	Item #	Lbs.	
SIZE & MATERIAL	12" x 18"	Nylon	035797	.10	030843	.10	-	-	-	-	035760	.10
	2' x 3'	Nylon	030827	.25	030844	.25	030857	.25	030875	.25	030890	.25
	3' x 5'	Nylon	030829	.45	030845	.45	030859	.45	030876	.45	030892	.45
	4' x 6'	Nylon	030830	.70	030846	.70	030860	.70	030877	.70	030893	.70
	5' x 8'	Nylon	030831	1.0	030847	1.0	030861	1.0	030878	1.0	030894	1.0
	6' x 10'	Nylon	035047	1.8	035048	1.8	035049	1.8	035050	1.8	035051	1.8
	3' x 5'	E-Poly	-	-	-	-	-	-	-	-	030891	.27



		CHINA (UN)		COLOMBIA (UN/OAS)		COMOROS (UN)		CONGO DEMOCRATIC REPUBLIC (UN)		CONGO REPUBLIC (UN)		
PRICE CATEGORY		C		A		E		D		D		
		Item #	Lbs.	Item #	Lbs.	Item #	Lbs.	Item #	Lbs.	Item #	Lbs.	
SIZE & MATERIAL	2' x 3'	Nylon	030911	.25	030937	.25	030959	.25	030979	.25	030994	.25
	3' x 5'	Nylon	030913	.45	030939	.45	030961	.45	030980	.45	030995	.45
	4' x 6'	Nylon	030914	.70	030940	.70	030962	.70	030981	.70	030996	.70
	5' x 8'	Nylon	030915	1.0	030941	1.0	030963	1.0	030982	1.0	030997	1.0
	6' x 10'	Nylon	035052	1.8	035054	1.8	035055	1.8	035056	1.8	035057	1.8
	3' x 5'	E-Poly	-	-	030938	.27	-	-	-	-	-	-



		COSTA RICA w/SEAL (UN/OAS)		COSTA RICA (NO SEAL)		CÔTE D'IVOIRE (UN)		CROATIA (UN)		CUBA (UN/OAS)		
PRICE CATEGORY		F		A		A		D		B		
		Item #	Lbs.	Item #	Lbs.	Item #	Lbs.	Item #	Lbs.	Item #	Lbs.	
SIZE & MATERIAL	12" x 18"	Nylon	-	-	-	-	031048	.10	-	-	031086	.10
	2' x 3'	Nylon	031016	.25	031035	.25	031049	.25	031065	.25	031087	.25
	3' x 5'	Nylon	031018	.45	031036	.45	031050	.45	031067	.45	031089	.45
	4' x 6'	Nylon	031019	.70	031037	.70	031051	.70	031068	.70	031090	.70
	5' x 8'	Nylon	031020	1.0	031038	1.0	031052	1.0	031069	1.0	031091	1.0
	6' x 10'	Nylon	035059	1.8	035058	1.8	035060	1.8	035061	1.8	035062	1.8

FLAGS OF THE WORLD OUTDOOR PRICE GUIDE

PRICE CATEGORY		A - WORLD		B - WORLD		C - WORLD		D - WORLD		E - WORLD		F - WORLD		
QUANTITY		1-5	6+	1-5	6+	1-5	6+	1-5	6+	1-5	6+	1-5	6+	
SIZE & MATERIAL	12" x 18"	Nylon	\$16.10	\$14.40	\$17.00	\$15.60	\$18.80	\$17.00	\$20.70	\$18.60	\$20.70	\$18.60	\$20.70	\$18.60
	2' x 3'	Nylon	27.80	25.30	34.80	31.00	40.40	36.60	45.50	41.10	48.60	42.80	61.80	55.50
	3' x 5'	Nylon	37.50	33.50	55.50	50.50	64.00	56.50	65.00	58.50	74.50	67.50	85.50	76.00
	4' x 6'	Nylon	52.00	46.50	89.00	80.50	93.50	84.00	97.00	88.50	107.00	96.00	119.50	107.00
	5' x 8'	Nylon	80.00	77.00	115.00	111.00	130.00	125.00	132.00	126.00	151.00	146.00	161.00	150.00
	6' x 10'	Nylon	130.00	-	212.00	-	239.00	-	260.00	-	298.00	-	333.00	-
	3' x 5'	E-Poly	30.00	26.50	30.00	26.50	30.00	26.50	30.00	26.50	30.00	26.50	30.00	26.50

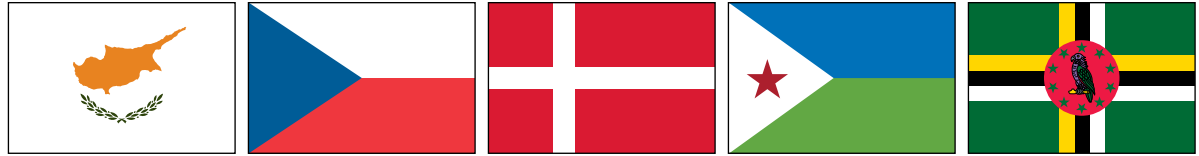

		CYPRUS (UN)		CZECH REPUBLIC (UN)		DENMARK (UN)		DJIBOUTI (UN)		DOMINICA (UN/OAS)		
PRICE CATEGORY		E		C		B		E		F		
		Item #	Lbs.	Item #	Lbs.	Item #	Lbs.	Item #	Lbs.	Item #	Lbs.	
SIZE & MATERIAL	12" x 18"	Nylon	–	–	035861	.10	–	–	–	–	035763	.10
	2' x 3'	Nylon	031111	.25	031131	.25	031154	.25	031173	.25	031191	.25
	3' x 5'	Nylon	031113	.45	031133	.45	031156	.45	031175	.45	031193	.45
	4' x 6'	Nylon	031114	.70	031134	.70	031157	.70	031176	.70	031194	.70
	5' x 8'	Nylon	031115	1.0	031135	1.0	031158	1.0	031177	1.0	031195	1.0
	6' x 10'	Nylon	035063	1.8	035064	1.8	035065	1.8	035066	1.8	035067	1.8
	3' x 5'	E-Poly	–	–	031132	.27	031155	.27	–	–	–	–



		DOMINICAN REPUBLIC w/SEAL (UN/OAS)		DOMINICAN REPUBLIC (NO SEAL)		EAST TIMOR (UN)		ECOLOGY		ECUADOR w/SEAL (UN/OAS)		
PRICE CATEGORY		F		B		C		D		F		
		Item #	Lbs.	Item #	Lbs.	Item #	Lbs.	Item #	Lbs.	Item #	Lbs.	
SIZE & MATERIAL	12" x 18"	Nylon	–	–	031230	.10	–	–	–	–	–	
	2' x 3'	Nylon	031212	.25	031231	.25	035801	.25	031250	.25	031270	.25
	3' x 5'	Nylon	031214	.45	031232	.45	035802	.45	031251	.45	031272	.45
	4' x 6'	Nylon	031215	.70	031233	.70	035803	.70	031252	.70	031273	.70
	5' x 8'	Nylon	031216	1.0	031234	1.0	035804	1.0	031253	1.0	031274	1.0
	6' x 10'	Nylon	035069	1.8	035068	1.8	035814	1.8	031254	1.8	035071	1.8
	3' x 5'	E-Poly	031213	.27	–	–	–	–	–	–	031271	.27



		ECUADOR (NO SEAL)		EGYPT (UN)		EL SALVADOR w/SEAL (UN/OAS)		EL SALVADOR (NO SEAL)		ENGLAND		
PRICE CATEGORY		A		C		E		A		B		
		Item #	Lbs.	Item #	Lbs.	Item #	Lbs.	Item #	Lbs.	Item #	Lbs.	
SIZE & MATERIAL	2' x 3'	Nylon	031289	.25	031305	.25	031323	.25	031341	.25	031354	.25
	3' x 5'	Nylon	031290	.45	031307	.45	031325	.45	031342	.45	031356	.45
	4' x 6'	Nylon	031291	.70	031308	.70	031326	.70	031343	.70	031357	.70
	5' x 8'	Nylon	031292	1.0	031309	1.0	031327	1.0	031344	1.0	031358	1.0
	6' x 10'	Nylon	035070	1.8	035072	1.8	035074	1.8	035073	1.8	035075	1.8
	3' x 5'	E-Poly	–	–	–	–	031324	.27	–	–	–	–

FLAGS OF THE WORLD OUTDOOR PRICE GUIDE														
PRICE CATEGORY		A - WORLD		B - WORLD		C - WORLD		D - WORLD		E - WORLD		F - WORLD		
QUANTITY		1-5	6+	1-5	6+	1-5	6+	1-5	6+	1-5	6+	1-5	6+	
SIZE & MATERIAL	12" x 18"	Nylon	\$16.10	\$14.40	\$17.00	\$15.60	\$18.80	\$17.00	\$20.70	\$18.60	\$20.70	\$18.60	\$20.70	\$18.60
	2' x 3'	Nylon	27.80	25.30	34.80	31.00	40.40	36.60	45.50	41.10	48.60	42.80	61.80	55.50
	3' x 5'	Nylon	37.50	33.50	55.50	50.50	64.00	56.50	65.00	58.50	74.50	67.50	85.50	76.00
	4' x 6'	Nylon	52.00	46.50	89.00	80.50	93.50	84.00	97.00	88.50	107.00	96.00	119.50	107.00
	5' x 8'	Nylon	80.00	77.00	115.00	111.00	130.00	125.00	132.00	126.00	151.00	146.00	161.00	150.00
	6' x 10'	Nylon	130.00	-	212.00	-	239.00	-	260.00	-	298.00	-	333.00	-
3' x 5'	E-Poly	30.00	26.50	30.00	26.50	30.00	26.50	30.00	26.50	30.00	26.50	30.00	26.50	



		EQUATORIAL GUINEA (UN)		ERIN GO BRAGH		ERITREA (UN)		ESTONIA (UN)		ETHIOPIA (UN)		
PRICE CATEGORY		F		D		E		A		D		
		Item #	Lbs.	Item #	Lbs.	Item #	Lbs.	Item #	Lbs.	Item #	Lbs.	
SIZE & MATERIAL	2' x 3'	Nylon	031370	.25	031388	.25	031403	.25	031418	.25	031432	.25
	3' x 5'	Nylon	031372	.45	031390	.45	031404	.45	031419	.45	031434	.45
	4' x 6'	Nylon	031373	.70	031391	.70	031405	.70	031420	.70	031435	.70
	5' x 8'	Nylon	031374	1.0	-	-	031406	1.0	031421	1.0	031436	1.0
	6' x 10'	Nylon	035076	1.8	-	-	-	-	035078	1.8	035079	1.8



		ETHIOPIA w/LION		EUROPE		FALKLAND ISLANDS		FAROE ISLANDS		FIJI (UN)		
PRICE CATEGORY		D		D		F		B		F		
		Item #	Lbs.	Item #	Lbs.	Item #	Lbs.	Item #	Lbs.	Item #	Lbs.	
SIZE & MATERIAL	2' x 3'	Nylon	-	-	031452	.25	031469	.25	031487	.25	031504	.25
	3' x 5'	Nylon	-	-	031454	.45	031471	.45	031489	.45	031506	.45
	4' x 6'	Nylon	-	-	031455	.70	031472	.70	031490	.70	031507	.70
	5' x 8'	Nylon	-	-	031456	1.0	031473	1.0	031491	1.0	031508	1.0
	6' x 10'	Nylon	-	-	035080	1.8	035081	1.8	035082	1.8	035083	1.8
	3' x 5'	E-Poly	031448	.27	-	-	-	-	-	-	-	-



		FINLAND (UN)		FRANCE (UN)		FRENCH POLYNESIA		GABON (UN)		GAMBIA (UN)		
PRICE CATEGORY		B		A		E		A		C		
		Item #	Lbs.	Item #	Lbs.	Item #	Lbs.	Item #	Lbs.	Item #	Lbs.	
SIZE & MATERIAL	2' x 3'	Nylon	031525	.25	031551	.25	031569	.25	031586	.25	031601	.25
	3' x 5'	Nylon	031527	.45	031553	.45	031571	.45	031587	.45	031603	.45
	4' x 6'	Nylon	031528	.70	031554	.70	031572	.70	031588	.70	031604	.70
	5' x 8'	Nylon	031529	1.0	031555	1.0	031573	1.0	031589	1.0	031605	1.0
	6' x 10'	Nylon	035084	1.8	035085	1.8	035086	1.8	035087	1.8	035088	1.8
	3' x 5'	E-Poly	-	-	031552	.27	-	-	-	-	-	-

FLAGS OF THE WORLD OUTDOOR PRICE GUIDE

PRICE CATEGORY		A - WORLD		B - WORLD		C - WORLD		D - WORLD		E - WORLD		F - WORLD		
QUANTITY		1-5	6+	1-5	6+	1-5	6+	1-5	6+	1-5	6+	1-5	6+	
SIZE & MATERIAL	12" x 18"	Nylon	\$16.10	\$14.40	\$17.00	\$15.60	\$18.80	\$17.00	\$20.70	\$18.60	\$20.70	\$18.60	\$20.70	\$18.60
	2' x 3'	Nylon	27.80	25.30	34.80	31.00	40.40	36.60	45.50	41.10	48.60	42.80	61.80	55.50
	3' x 5'	Nylon	37.50	33.50	55.50	50.50	64.00	56.50	65.00	58.50	74.50	67.50	85.50	76.00
	4' x 6'	Nylon	52.00	46.50	89.00	80.50	93.50	84.00	97.00	88.50	107.00	96.00	119.50	107.00
	5' x 8'	Nylon	80.00	77.00	115.00	111.00	130.00	125.00	132.00	126.00	151.00	146.00	161.00	150.00
	6' x 10'	Nylon	130.00	-	212.00	-	239.00	-	260.00	-	298.00	-	333.00	-
3' x 5'	E-Poly	30.00	26.50	30.00	26.50	30.00	26.50	30.00	26.50	30.00	26.50	30.00	26.50	



		GEORGIA REPUBLIC (UN)		GERMANY (UN)		GERMANY w/EAGLE		GHANA (UN)		GIBRALTAR		
PRICE CATEGORY		D		A		D		C		E		
		Item #	Lbs.	Item #	Lbs.	Item #	Lbs.	Item #	Lbs.	Item #	Lbs.	
SIZE & MATERIAL	12" x 18"	Nylon	–	–	031669	.10	–	–	–	–	035764	.10
	2' x 3'	Nylon	031619	.25	031670	.25	031638	.25	031689	.25	035796	.25
	3' x 5'	Nylon	031621	.45	031672	.45	031640	.45	031691	.45	031707	.45
	4' x 6'	Nylon	031622	.70	031673	.70	031641	.70	031692	.70	031708	.70
	5' x 8'	Nylon	031623	1.0	031674	1.0	031642	1.0	031693	1.0	031709	1.0
	6' x 10'	Nylon	035089	1.8	035090	1.8	035091	1.8	035092	1.8	035093	1.8
	3' x 5'	E-Poly	–	–	031671	.27	031639	.27	031690	.27	–	–



		GREECE (UN)		GREENLAND		GRENADA (UN/OAS)		GUATEMALA w/SEAL (UN/OAS)		GUATEMALA (NO SEAL)		
PRICE CATEGORY		B		E		E		E		A		
		Item #	Lbs.	Item #	Lbs.	Item #	Lbs.	Item #	Lbs.	Item #	Lbs.	
SIZE & MATERIAL	12" x 18"	Nylon	031723	.10	–	–	035765	.10	–	–	–	–
	2' x 3'	Nylon	031724	.25	–	–	031752	.25	031771	.25	031789	.25
	3' x 5'	Nylon	031726	.45	031744	.45	031754	.45	031773	.45	031790	.45
	4' x 6'	Nylon	031727	.70	–	–	031755	.70	031774	.70	031791	.70
	5' x 8'	Nylon	031728	1.0	–	–	031756	1.0	031775	1.0	031792	1.0
	6' x 10'	Nylon	035094	1.8	–	–	035095	1.8	035097	1.8	035096	1.8
	3' x 5'	E-Poly	031725	.27	–	–	–	–	031772	.27	–	–



		GUINEA (UN)		GUINEA-BISSAU (UN)		GUYANA (UN/OAS)		HAITI w/SEAL (UN/OAS)		HAITI (NO SEAL)		
PRICE CATEGORY		A		C		E		F		A		
		Item #	Lbs.	Item #	Lbs.	Item #	Lbs.	Item #	Lbs.	Item #	Lbs.	
SIZE & MATERIAL	2' x 3'	Nylon	031808	.25	031822	.25	031840	.25	031859	.25	031877	.25
	3' x 5'	Nylon	031809	.45	031824	.45	031842	.45	031861	.45	031878	.45
	4' x 6'	Nylon	031810	.70	031825	.70	031843	.70	031862	.70	031879	.70
	5' x 8'	Nylon	031811	1.0	031826	1.0	031844	1.0	031863	1.0	031880	1.0
	6' x 10'	Nylon	035098	1.8	035099	1.8	035100	1.8	035102	1.8	035101	1.8
	3' x 5'	E-Poly	–	–	–	–	–	–	031860	.27	–	–

### FLAGS OF THE WORLD OUTDOOR PRICE GUIDE

PRICE CATEGORY		A - WORLD		B - WORLD		C - WORLD		D - WORLD		E - WORLD		F - WORLD		
QUANTITY		1-5	6+	1-5	6+	1-5	6+	1-5	6+	1-5	6+	1-5	6+	
SIZE & MATERIAL	12" x 18"	Nylon	\$16.10	\$14.40	\$17.00	\$15.60	\$18.80	\$17.00	\$20.70	\$18.60	\$20.70	\$18.60	\$20.70	\$18.60
	2' x 3'	Nylon	27.80	25.30	34.80	31.00	40.40	36.60	45.50	41.10	48.60	42.80	61.80	55.50
	3' x 5'	Nylon	37.50	33.50	55.50	50.50	64.00	56.50	65.00	58.50	74.50	67.50	85.50	76.00
	4' x 6'	Nylon	52.00	46.50	89.00	80.50	93.50	84.00	97.00	88.50	107.00	96.00	119.50	107.00
	5' x 8'	Nylon	80.00	77.00	115.00	111.00	130.00	125.00	132.00	126.00	151.00	146.00	161.00	150.00
	6' x 10'	Nylon	130.00	–	212.00	–	239.00	–	260.00	–	298.00	–	333.00	–
	3' x 5'	E-Poly	30.00	26.50	30.00	26.50	30.00	26.50	30.00	26.50	30.00	26.50	30.00	26.50



		HONDURAS (UN/OAS)		HONG KONG		HUNGARY (UN)		HUNGARY (1921-1946)		ICELAND (UN)		
PRICE CATEGORY		C		E		A		E		C		
		Item #	Lbs.	Item #	Lbs.	Item #	Lbs.	Item #	Lbs.	Item #	Lbs.	
SIZE & MATERIAL	12" x 18"	Nylon	035766	.10	-	-	-	-	-	-	-	
	2' x 3'	Nylon	031894	.25	031912	.25	031928	.25	031945	.25	031960	.25
	3' x 5'	Nylon	031896	.45	031913	.45	031930	.45	031947	.45	031962	.45
	4' x 6'	Nylon	031897	.70	031914	.70	031931	.70	031948	.70	031963	.70
	5' x 8'	Nylon	031898	1.0	031915	1.0	031932	1.0	031949	1.0	031964	1.0
	6' x 10'	Nylon	035103	1.8	035104	1.8	035105	1.8	035106	1.8	035107	1.8
	3' x 5'	E-Poly	031895	.27	-	-	031929	.27	-	-	-	-



		INDIA (UN)		INDONESIA (UN)		IRAN (UN)		IRAQ (UN)*		IRELAND (UN)		
PRICE CATEGORY		C		A		C		F		A		
		Item #	Lbs.	Item #	Lbs.	Item #	Lbs.	Item #	Lbs.	Item #	Lbs.	
SIZE & MATERIAL	12" x 18"	Nylon	-	-	-	-	-	-	-	032057	.10	
	2' x 3'	Nylon	031983	.25	032003	.25	032020	.25	032037	.25	032058	.25
	3' x 5'	Nylon	031985	.45	032005	.45	032022	.45	032039	.45	032060	.45
	4' x 6'	Nylon	031986	.70	032006	.70	032023	.70	032040	.70	032061	.70
	5' x 8'	Nylon	031987	1.0	032007	1.0	032024	1.0	032041	1.0	032062	1.0
	6' x 10'	Nylon	035108	1.8	035109	1.8	-	-	035111	1.8	035112	1.8
	3' x 5'	E-Poly	031984	.27	-	-	-	-	032038	.27	032059	.27

\*2' x 3' flags sewn back to back. Other sizes two center panels sewn back to back.



		ISRAEL (UN)		ITALIAN ENSIGN		ITALY (UN)		JAMAICA (UN/OAS)		JAPAN (UN)		
PRICE CATEGORY		B		E		A		D		B		
		Item #	Lbs.	Item #	Lbs.	Item #	Lbs.	Item #	Lbs.	Item #	Lbs.	
SIZE & MATERIAL	12" x 18"	Nylon	-	-	-	-	-	-	-	032167	.10	
	2' x 3'	Nylon	032081	.25	032099	.25	032119	.25	032142	.25	032168	.25
	3' x 5'	Nylon	032083	.45	032101	.45	032121	.45	032144	.45	032170	.45
	4' x 6'	Nylon	032084	.70	032102	.70	032122	.70	032145	.70	032171	.70
	5' x 8'	Nylon	032085	1.0	032103	1.0	032123	1.0	032146	1.0	032172	1.0
	6' x 10'	Nylon	040113	1.8	035114	1.8	035115	1.8	035116	1.8	035117	1.8
	3' x 5'	E-Poly	-	-	-	-	-	-	-	-	032169	.27

FLAGS OF THE WORLD OUTDOOR PRICE GUIDE

PRICE CATEGORY		A - WORLD		B - WORLD		C - WORLD		D - WORLD		E - WORLD		F - WORLD		
QUANTITY		1-5	6+	1-5	6+	1-5	6+	1-5	6+	1-5	6+	1-5	6+	
SIZE & MATERIAL	12" x 18"	Nylon	\$16.10	\$14.40	\$17.00	\$15.60	\$18.80	\$17.00	\$20.70	\$18.60	\$20.70	\$18.60	\$20.70	\$18.60
	2' x 3'	Nylon	27.80	25.30	34.80	31.00	40.40	36.60	45.50	41.10	48.60	42.80	61.80	55.50
	3' x 5'	Nylon	37.50	33.50	55.50	50.50	64.00	56.50	65.00	58.50	74.50	67.50	85.50	76.00
	4' x 6'	Nylon	52.00	46.50	89.00	80.50	93.50	84.00	97.00	88.50	107.00	96.00	119.50	107.00
	5' x 8'	Nylon	80.00	77.00	115.00	111.00	130.00	125.00	132.00	126.00	151.00	146.00	161.00	150.00
	6' x 10'	Nylon	130.00	-	212.00	-	239.00	-	260.00	-	298.00	-	333.00	-
	3' x 5'	E-Poly	30.00	26.50	30.00	26.50	30.00	26.50	30.00	26.50	30.00	26.50	30.00	26.50



			JAPANESE ENSIGN		JORDAN (UN)		KAZAKHSTAN (UN)		KENYA (UN)		KIRIBATI (UN)	
PRICE CATEGORY			E		D		D		D		E	
			Item #	Lbs.	Item #	Lbs.	Item #	Lbs.	Item #	Lbs.	Item #	Lbs.
SIZE & MATERIAL	2' x 3'	Nylon	032189	.25	032212	.25	032229	.25	032246	.25	032269	.25
	3' x 5'	Nylon	032191	.45	032214	.45	032231	.45	032248	.45	032271	.45
	4' x 6'	Nylon	032192	.70	032215	.70	032232	.70	032249	.70	032272	.70
	5' x 8'	Nylon	032193	1.0	032216	1.0	032233	1.0	032250	1.0	032273	1.0
	6' x 10'	Nylon	-	-	035119	1.8	-	-	-	-	-	-



			NORTH KOREA (UN)		SOUTH KOREA (UN)		KOSOVO		KUWAIT (UN)		KYRGYZSTAN (UN)	
PRICE CATEGORY			E		D		F		C		E	
			Item #	Lbs.	Item #	Lbs.	Item #	Lbs.	Item #	Lbs.	Item #	Lbs.
SIZE & MATERIAL	2' x 3'	Nylon	032286	.25	032305	.25	035887	.25	032323	.25	032340	.25
	3' x 5'	Nylon	032288	.45	032307	.45	035888	.45	032325	.45	032342	.45
	4' x 6'	Nylon	032289	.70	032308	.70	035889	.70	032326	.70	032343	.70
	5' x 8'	Nylon	032290	1.0	032309	1.0	035890	1.0	032327	1.0	032344	1.0
	6' x 10'	Nylon	035165	1.8	035202	1.8	035891	1.8	035123	1.8	035124	1.8
	3' x 5'	E-Poly	-	-	032306	.27	-	-	-	-	-	-



			LAOS (UN)		LATVIA (UN)		LEBANON (UN)		LESOTHO (UN)		LIBERIA (UN)	
PRICE CATEGORY			C		A		D		D		D	
			Item #	Lbs.	Item #	Lbs.	Item #	Lbs.	Item #	Lbs.	Item #	Lbs.
SIZE & MATERIAL	2' x 3'	Nylon	032357	.25	032375	.25	032392	.25	032409	.25	032426	.25
	3' x 5'	Nylon	032359	.45	032377	.45	032394	.45	032411	.45	032428	.45
	4' x 6'	Nylon	032360	.70	032378	.70	032395	.70	032412	.70	032429	.70
	5' x 8'	Nylon	032361	1.0	032379	1.0	032396	1.0	032413	1.0	032430	1.0
	6' x 10'	Nylon	035125	1.8	035126	1.8	035127	1.8	035128	1.8	035129	1.8

FLAGS OF THE WORLD OUTDOOR PRICE GUIDE														
PRICE CATEGORY			A - WORLD		B - WORLD		C - WORLD		D - WORLD		E - WORLD		F - WORLD	
QUANTITY			1-5	6+	1-5	6+	1-5	6+	1-5	6+	1-5	6+	1-5	6+
SIZE & MATERIAL	12" x 18"	Nylon	\$16.10	\$14.40	\$17.00	\$15.60	\$18.80	\$17.00	\$20.70	\$18.60	\$20.70	\$18.60	\$20.70	\$18.60
	2' x 3'	Nylon	27.80	25.30	34.80	31.00	40.40	36.60	45.50	41.10	48.60	42.80	61.80	55.50
	3' x 5'	Nylon	37.50	33.50	55.50	50.50	64.00	56.50	65.00	58.50	74.50	67.50	85.50	76.00
	4' x 6'	Nylon	52.00	46.50	89.00	80.50	93.50	84.00	97.00	88.50	107.00	96.00	119.50	107.00
	5' x 8'	Nylon	80.00	77.00	115.00	111.00	130.00	125.00	132.00	126.00	151.00	146.00	161.00	150.00
	6' x 10'	Nylon	130.00	-	212.00	-	239.00	-	260.00	-	298.00	-	333.00	-
	3' x 5'	E-Poly	30.00	26.50	30.00	26.50	30.00	26.50	30.00	26.50	30.00	26.50	30.00	26.50



		LIBYA (UN)		LIECHTENSTEIN (UN)		LITHUANIA (UN)		LUXEMBOURG (UN)		MACAU		
PRICE CATEGORY		A		E		A		A		F		
		Item #	Lbs.	Item #	Lbs.	Item #	Lbs.	Item #	Lbs.	Item #	Lbs.	
SIZE & MATERIAL	2' x 3'	Nylon	032444	.25	032461	.25	032479	.25	032499	.25	-	-
	3' x 5'	Nylon	032446	.45	032463	.45	032481	.45	032501	.45	032516	.45
	4' x 6'	Nylon	032447	.70	032464	.70	032482	.70	032502	.70	-	-
	5' x 8'	Nylon	032448	1.0	032465	1.0	032483	1.0	032503	1.0	-	-
	6' x 10'	Nylon	035130	1.8	035131	1.8	035132	1.8	035133	1.8	-	-



		MACEDONIA (UN)		MADAGASCAR (UN)		MALAWI (UN)		MALAYSIA (UN)		MALDIVES (UN)		
PRICE CATEGORY		D		A		D		E		D		
		Item #	Lbs.	Item #	Lbs.	Item #	Lbs.	Item #	Lbs.	Item #	Lbs.	
SIZE & MATERIAL	2' x 3'	Nylon	032520	.25	032534	.25	032551	.25	032568	.25	032585	.25
	3' x 5'	Nylon	032521	.45	032536	.45	032553	.45	032570	.45	032587	.45
	4' x 6'	Nylon	032522	.70	032537	.70	032554	.70	032571	.70	032588	.70
	5' x 8'	Nylon	032523	1.0	032538	1.0	032555	1.0	032572	1.0	032589	1.0
	6' x 10'	Nylon	-	-	035135	1.8	035136	1.8	035137	1.8	035138	1.8



		MALI (UN)		MALTA (UN)		ISLE OF MAN		MARSHALL ISLANDS (UN)		MAURITANIA (UN)		
PRICE CATEGORY		A		D		E		C		E		
		Item #	Lbs.	Item #	Lbs.	Item #	Lbs.	Item #	Lbs.	Item #	Lbs.	
SIZE & MATERIAL	2' x 3'	Nylon	032603	.25	032620	.25	-	-	032645	.25	032662	.25
	3' x 5'	Nylon	032605	.45	032622	.45	032638	.45	032647	.45	032664	.45
	4' x 6'	Nylon	032606	.70	032623	.70	-	-	032648	.70	032665	.70
	5' x 8'	Nylon	032607	1.0	032624	1.0	-	-	032649	1.0	032666	1.0
	6' x 10'	Nylon	035139	1.8	035140	1.8	-	-	035141	1.8	035142	1.8

FLAGS OF THE WORLD OUTDOOR PRICE GUIDE

PRICE CATEGORY		A - WORLD		B - WORLD		C - WORLD		D - WORLD		E - WORLD		F - WORLD		
QUANTITY		1-5	6+	1-5	6+	1-5	6+	1-5	6+	1-5	6+	1-5	6+	
SIZE & MATERIAL	12" x 18"	Nylon	\$16.10	\$14.40	\$17.00	\$15.60	\$18.80	\$17.00	\$20.70	\$18.60	\$20.70	\$18.60	\$20.70	\$18.60
	2' x 3'	Nylon	27.80	25.30	34.80	31.00	40.40	36.60	45.50	41.10	48.60	42.80	61.80	55.50
	3' x 5'	Nylon	37.50	33.50	55.50	50.50	64.00	56.50	65.00	58.50	74.50	67.50	85.50	76.00
	4' x 6'	Nylon	52.00	46.50	89.00	80.50	93.50	84.00	97.00	88.50	107.00	96.00	119.50	107.00
	5' x 8'	Nylon	80.00	77.00	115.00	111.00	130.00	125.00	132.00	126.00	151.00	146.00	161.00	150.00
	6' x 10'	Nylon	130.00	-	212.00	-	239.00	-	260.00	-	298.00	-	333.00	-
	3' x 5'	E-Poly	30.00	26.50	30.00	26.50	30.00	26.50	30.00	26.50	30.00	26.50	30.00	26.50

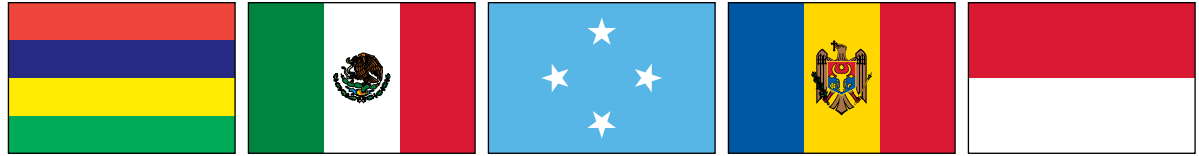

			MAURITIUS (UN)		MEXICO (UN/OAS)		MICRONESIA (UN)		MOLDOVA (UN)		MONACO (UN)	
PRICE CATEGORY			A		B		B		F		A	
			Item #	Lbs.	Item #	Lbs.	Item #	Lbs.	Item #	Lbs.	Item #	Lbs.
SIZE & MATERIAL	2' x 3'	Nylon	032680	.25	032701	.25	032720	.25	032737	.25	032758	.25
	3' x 5'	Nylon	032682	.45	032703	.45	032722	.45	032739	.45	032760	.45
	4' x 6'	Nylon	032683	.70	032704	.70	032723	.70	032740	.70	032761	.70
	5' x 8'	Nylon	032684	1.0	032705	1.0	032724	1.0	032741	1.0	032762	1.0
	6' x 10'	Nylon	035143	1.8	035144	1.8	035145	1.8	035146	1.8	035147	1.8
	3' x 5'	E-Poly	-	-	032702	.27	-	-	-	-	-	-



			MONGOLIA (UN)		MONTENEGRO (UN)		MONTSERRAT		MOROCCO (UN)		MOZAMBIQUE (UN)	
PRICE CATEGORY			D		F		F		E		E	
			Item #	Lbs.	Item #	Lbs.	Item #	Lbs.	Item #	Lbs.	Item #	Lbs.
SIZE & MATERIAL	2' x 3'	Nylon	032777	.25	032794	.25	035828	.25	032820	.25	032837	.25
	3' x 5'	Nylon	032779	.45	032795	.45	032807	.45	032822	.45	032839	.45
	4' x 6'	Nylon	032780	.70	032796	.70	032808	.70	032823	.70	032840	.70
	5' x 8'	Nylon	032781	1.0	032797	1.0	032809	1.0	032824	1.0	032841	1.0
	6' x 10'	Nylon	035148	1.8	035149	1.8	035150	1.8	035151	1.8	035152	1.8



			MYANMAR (UN)		NAMIBIA (UN)		NATO		NAURU (UN)		NEPAL (UN)	
PRICE CATEGORY			D		E		E		E		E	
			Item #	Lbs.	Item #	Lbs.	Item #	Lbs.	Item #	Lbs.	Item #	Lbs.
SIZE & MATERIAL	2' x 3'	Nylon	032854	.25	032868	.25	032885	.25	032902	.25	032919	.20
	3' x 5'	Nylon	032855	.45	032870	.45	032887	.45	032904	.45	032921	.35
	4' x 6'	Nylon	032856	.70	032871	.70	032888	.70	032905	.70	032922	.55
	5' x 8'	Nylon	032857	1.0	032872	1.0	032889	1.0	032906	1.0	032923	.75
	6' x 10'	Nylon	035153	1.8	035154	1.8	035155	1.8	035156	1.8	035157	1.8

FLAGS OF THE WORLD OUTDOOR PRICE GUIDE														
PRICE CATEGORY			A - WORLD		B - WORLD		C - WORLD		D - WORLD		E - WORLD		F - WORLD	
QUANTITY			1-5	6+	1-5	6+	1-5	6+	1-5	6+	1-5	6+	1-5	6+
SIZE & MATERIAL	12" x 18"	Nylon	\$16.10	\$14.40	\$17.00	\$15.60	\$18.80	\$17.00	\$20.70	\$18.60	\$20.70	\$18.60	\$20.70	\$18.60
	2' x 3'	Nylon	27.80	25.30	34.80	31.00	40.40	36.60	45.50	41.10	48.60	42.80	61.80	55.50
	3' x 5'	Nylon	37.50	33.50	55.50	50.50	64.00	56.50	65.00	58.50	74.50	67.50	85.50	76.00
	4' x 6'	Nylon	52.00	46.50	89.00	80.50	93.50	84.00	97.00	88.50	107.00	96.00	119.50	107.00
	5' x 8'	Nylon	80.00	77.00	115.00	111.00	130.00	125.00	132.00	126.00	151.00	146.00	161.00	150.00
	6' x 10'	Nylon	130.00	-	212.00	-	239.00	-	260.00	-	298.00	-	333.00	-
	3' x 5'	E-Poly	30.00	26.50	30.00	26.50	30.00	26.50	30.00	26.50	30.00	26.50	30.00	26.50

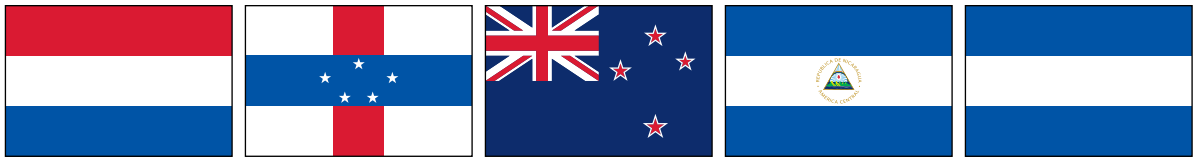

		NETHERLANDS (UN)		NETHERLANDS ANTILLES		NEW ZEALAND (UN)		NICARAGUA w/SEAL (UN/OAS)		NICARAGUA (NO SEAL)		
PRICE CATEGORY		A		E		C		F		A		
		Item #	Lbs.	Item #	Lbs.	Item #	Lbs.	Item #	Lbs.	Item #	Lbs.	
SIZE & MATERIAL	12" x 18"	Nylon	–	–	035767	.10	–	–	–	–	–	–
	2' x 3'	Nylon	032940	.25	032959	.25	032978	.25	032998	.25	033016	.25
	3' x 5'	Nylon	032942	.45	032961	.45	032980	.45	033000	.45	033017	.45
	4' x 6'	Nylon	032943	.70	032962	.70	032981	.70	033001	.70	033018	.70
	5' x 8'	Nylon	032944	1.0	032963	1.0	032982	1.0	033002	1.0	033019	1.0
	6' x 10'	Nylon	035158	1.8	035159	1.8	035160	1.8	035162	1.8	035161	1.8
	3' x 5'	E-Poly	032941	.27	–	–	032979	.27	032999	.27	–	–

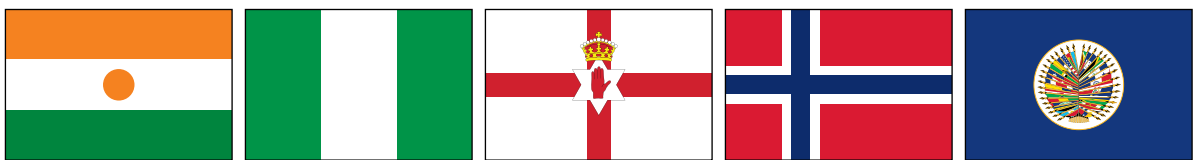

		NIGER (UN)		NIGERIA (UN)		NORTHERN IRELAND		NORWAY (UN)		OAS		
PRICE CATEGORY		C		A		E		B		F		
		Item #	Lbs.	Item #	Lbs.	Item #	Lbs.	Item #	Lbs.	Item #	Lbs.	
SIZE & MATERIAL	2' x 3'	Nylon	033029	.25	033047	.25	–	–	033083	.25	033101	.25
	3' x 5'	Nylon	033031	.45	033049	.45	033070	.45	033085	.45	033103	.45
	4' x 6'	Nylon	033032	.70	033050	.70	–	–	033086	.70	033104	.70
	5' x 8'	Nylon	033033	1.0	033051	1.0	–	–	033087	1.0	033105	1.0
	6' x 10'	Nylon	035163	1.8	035164	1.8	–	–	035166	1.8	035167	1.8
	3' x 5'	E-Poly	–	–	033048	.27	–	–	033084	.27	–	–



		OMAN (UN)		PAKISTAN (UN)		PALAU (UN)		PALESTINE		PANAMA (UN/OAS)		
PRICE CATEGORY		E		C		C		C		C		
		Item #	Lbs.	Item #	Lbs.	Item #	Lbs.	Item #	Lbs.	Item #	Lbs.	
SIZE & MATERIAL	12" x 18"	Nylon	–	–	035826	.10	035827	.10	–	–	–	–
	2' x 3'	Nylon	033131	.25	033149	.25	033167	.25	033184	.25	033205	.25
	3' x 5'	Nylon	033133	.45	033151	.45	033169	.45	033186	.45	033207	.45
	4' x 6'	Nylon	033134	.70	033152	.70	033170	.70	033187	.70	033208	.70
	5' x 8'	Nylon	033135	1.0	033153	1.0	033171	1.0	033188	1.0	033209	1.0
	6' x 10'	Nylon	035168	1.8	035169	1.8	035170	1.8	035171	1.8	035172	1.8
	3' x 5'	E-Poly	–	–	033150	.27	–	–	–	–	033206	.27

FLAGS OF THE WORLD OUTDOOR PRICE GUIDE

PRICE CATEGORY		A - WORLD		B - WORLD		C - WORLD		D - WORLD		E - WORLD		F - WORLD		
QUANTITY		1-5	6+	1-5	6+	1-5	6+	1-5	6+	1-5	6+	1-5	6+	
SIZE & MATERIAL	12" x 18"	Nylon	\$16.10	\$14.40	\$17.00	\$15.60	\$18.80	\$17.00	\$20.70	\$18.60	\$20.70	\$18.60	\$20.70	\$18.60
	2' x 3'	Nylon	27.80	25.30	34.80	31.00	40.40	36.60	45.50	41.10	48.60	42.80	61.80	55.50
	3' x 5'	Nylon	37.50	33.50	55.50	50.50	64.00	56.50	65.00	58.50	74.50	67.50	85.50	76.00
	4' x 6'	Nylon	52.00	46.50	89.00	80.50	93.50	84.00	97.00	88.50	107.00	96.00	119.50	107.00
	5' x 8'	Nylon	80.00	77.00	115.00	111.00	130.00	125.00	132.00	126.00	151.00	146.00	161.00	150.00
	6' x 10'	Nylon	130.00	-	212.00	-	239.00	-	260.00	-	298.00	-	333.00	-
	3' x 5'	E-Poly	30.00	26.50	30.00	26.50	30.00	26.50	30.00	26.50	30.00	26.50	30.00	26.50



		PAPUA NEW GUINEA (UN)		PARAGUAY (UN/OAS)		PERU w/SEAL (UN/OAS)		PERU (NO SEAL)		PHILIPPINES (UN)		
PRICE CATEGORY		E		D		E		A		D		
		Item #	Lbs.	Item #	Lbs.	Item #	Lbs.	Item #	Lbs.	Item #	Lbs.	
SIZE & MATERIAL	2' x 3'	Nylon	033224	.25	033242	.25	033261	.25	033279	.25	033295	.25
	3' x 5'	Nylon	033226	.45	033244	.45	033263	.45	033280	.45	033297	.45
	4' x 6'	Nylon	033227	.70	033245	.70	033264	.70	033281	.70	033298	.70
	5' x 8'	Nylon	033228	1.0	033246	1.0	033265	1.0	033282	1.0	033299	1.0
	6' x 10'	Nylon	035173	1.8	035174	1.8	-	-	035175	1.8	035177	1.8
	3' x 5'	E-Poly	-	-	-	-	033262	.27	-	-	033296	.27



		POLAND NO EAGLE (UN)		POLAND w/EAGLE		PORTUGAL (UN)		QATAR (UN)		ROMANIA (UN)		
PRICE CATEGORY		A		D		E		C		A		
		Item #	Lbs.	Item #	Lbs.	Item #	Lbs.	Item #	Lbs.	Item #	Lbs.	
SIZE & MATERIAL	12" x 18"	Nylon	-	-	-	-	035768	.10	-	-	-	-
	2' x 3'	Nylon	033322	.25	033345	.25	033367	.25	033386	.25	033422	.25
	3' x 5'	Nylon	033324	.45	033347	.45	033369	.45	033388	.45	033424	.45
	4' x 6'	Nylon	033325	.70	033348	.70	033370	.70	033389	.70	033425	.70
	5' x 8'	Nylon	033326	1.0	033349	1.0	033371	1.0	033390	1.0	033426	1.0
	6' x 10'	Nylon	035178	1.8	035179	1.8	035180	1.8	035181	1.8	035183	1.8
	3' x 5'	E-Poly	-	-	-	-	033368	.27	-	-	-	-



		RUSSIAN FEDERATION (UN)		RWANDA (UN)		ST. KITTS-NEVIS (UN/OAS)		ST. LUCIA (UN/OAS)		ST. VINCENT & THE GRENADINES (UN/OAS)		
PRICE CATEGORY		A		C		D		D		E		
		Item #	Lbs.	Item #	Lbs.	Item #	Lbs.	Item #	Lbs.	Item #	Lbs.	
SIZE & MATERIAL	12" x 18"	Nylon	033442	.10	-	-	035770	.10	035771	.10	035772	.10
	2' x 3'	Nylon	033443	.25	033465	.25	033483	.25	033519	.25	033538	.25
	3' x 5'	Nylon	033445	.45	033467	.45	033485	.45	033521	.45	033540	.45
	4' x 6'	Nylon	033446	.70	033468	.70	033486	.70	033522	.70	033541	.70
	5' x 8'	Nylon	033447	1.0	033469	1.0	033487	1.0	033523	1.0	033542	1.0
	6' x 10'	Nylon	035184	1.8	035185	1.8	035206	1.8	035208	1.8	035209	1.8
	3' x 5'	E-Poly	033444	.27	-	-	-	-	-	-	-	-

### FLAGS OF THE WORLD OUTDOOR PRICE GUIDE

PRICE CATEGORY		A - WORLD		B - WORLD		C - WORLD		D - WORLD		E - WORLD		F - WORLD		
QUANTITY		1-5	6+	1-5	6+	1-5	6+	1-5	6+	1-5	6+	1-5	6+	
SIZE & MATERIAL	12" x 18"	Nylon	\$16.10	\$14.40	\$17.00	\$15.60	\$18.80	\$17.00	\$20.70	\$18.60	\$20.70	\$18.60	\$20.70	\$18.60
	2' x 3'	Nylon	27.80	25.30	34.80	31.00	40.40	36.60	45.50	41.10	48.60	42.80	61.80	55.50
	3' x 5'	Nylon	37.50	33.50	55.50	50.50	64.00	56.50	65.00	58.50	74.50	67.50	85.50	76.00
	4' x 6'	Nylon	52.00	46.50	89.00	80.50	93.50	84.00	97.00	88.50	107.00	96.00	119.50	107.00
	5' x 8'	Nylon	80.00	77.00	115.00	111.00	130.00	125.00	132.00	126.00	151.00	146.00	161.00	150.00
	6' x 10'	Nylon	130.00	-	212.00	-	239.00	-	260.00	-	298.00	-	333.00	-
	3' x 5'	E-Poly	30.00	26.50	30.00	26.50	30.00	26.50	30.00	26.50	30.00	26.50	30.00	26.50



		SAMOA (UN)		SAN MARINO w/SEAL (UN)		SAN MARINO (NO SEAL)		SÃO TOMÉ & PRÍNCIPE (UN)		SAUDI ARABIA (UN)		
PRICE CATEGORY		C		F		A		E		C		
		Item #	Lbs.	Item #	Lbs.	Item #	Lbs.	Item #	Lbs.	Item #	Lbs.	
SIZE & MATERIAL	2' x 3'	Nylon	034526	.25	033556	.25	033574	.25	033588	.25	033604	.25
	3' x 5'	Nylon	034528	.45	033558	.45	033575	.45	033589	.45	033606	.45
	4' x 6'	Nylon	034529	.70	033559	.70	033576	.70	033590	.70	033607	.70
	5' x 8'	Nylon	034530	1.0	033560	1.0	033577	1.0	033591	1.0	033608	1.0
	6' x 10'	Nylon	035243	1.8	035187	1.8	035186	1.8	035188	1.8	035189	1.8



		SCOTLAND w/LION		SCOTLAND w/CROSS		SENEGAL (UN)		SERBIA (NO SEAL)		SERBIA w/SEAL (UN)		
PRICE CATEGORY		D		B		C		A		D		
		Item #	Lbs.	Item #	Lbs.	Item #	Lbs.	Item #	Lbs.	Item #	Lbs.	
SIZE & MATERIAL	12" x 18"	Nylon	-	-	033644	.10	-	-	-	-	-	
	2' x 3'	Nylon	033625	.25	033645	.25	033663	.25	033680	.25	035873	.25
	3' x 5'	Nylon	033627	.45	033647	.45	033665	.45	033681	.45	033694	.45
	4' x 6'	Nylon	033628	.70	033648	.70	033666	.70	033682	.70	035874	.70
	5' x 8'	Nylon	033629	1.0	033649	1.0	033667	1.0	033683	1.0	035875	1.0
	6' x 10'	Nylon	035191	1.8	035190	1.8	035192	1.8	035193	1.8	035882	1.8



		SEYCHELLES (UN)		SIERRA LEONE (UN)		SINGAPORE (UN)		SLOVAKIA (UN)		SLOVENIA (UN)		
PRICE CATEGORY		E		A		C		E		E		
		Item #	Lbs.	Item #	Lbs.	Item #	Lbs.	Item #	Lbs.	Item #	Lbs.	
SIZE & MATERIAL	2' x 3'	Nylon	033701	.25	033720	.25	033739	.25	033757	.25	033774	.25
	3' x 5'	Nylon	033703	.45	033722	.45	033741	.45	033759	.45	033776	.45
	4' x 6'	Nylon	033704	.70	033723	.70	033742	.70	033760	.70	033777	.70
	5' x 8'	Nylon	033705	1.0	033724	1.0	033743	1.0	033761	1.0	033778	1.0
	6' x 10'	Nylon	035194	1.8	035195	1.8	035196	1.8	035197	1.8	035198	1.8

FLAGS OF THE WORLD OUTDOOR PRICE GUIDE														
PRICE CATEGORY		A - WORLD		B - WORLD		C - WORLD		D - WORLD		E - WORLD		F - WORLD		
QUANTITY		1-5	6+	1-5	6+	1-5	6+	1-5	6+	1-5	6+	1-5	6+	
SIZE & MATERIAL	12" x 18"	Nylon	\$16.10	\$14.40	\$17.00	\$15.60	\$18.80	\$17.00	\$20.70	\$18.60	\$20.70	\$18.60	\$20.70	\$18.60
	2' x 3'	Nylon	27.80	25.30	34.80	31.00	40.40	36.60	45.50	41.10	48.60	42.80	61.80	55.50
	3' x 5'	Nylon	37.50	33.50	55.50	50.50	64.00	56.50	65.00	58.50	74.50	67.50	85.50	76.00
	4' x 6'	Nylon	52.00	46.50	89.00	80.50	93.50	84.00	97.00	88.50	107.00	96.00	119.50	107.00
	5' x 8'	Nylon	80.00	77.00	115.00	111.00	130.00	125.00	132.00	126.00	151.00	146.00	161.00	150.00
	6' x 10'	Nylon	130.00	-	212.00	-	239.00	-	260.00	-	298.00	-	333.00	-
	3' x 5'	E-Poly	30.00	26.50	30.00	26.50	30.00	26.50	30.00	26.50	30.00	26.50	30.00	26.50



		SOLOMON ISLANDS (UN)		SOMALIA (UN)		SOUTH AFRICA (UN)		SOUTH SUDAN (UN)		SPAIN w/SEAL (UN)		
PRICE CATEGORY		E		B		E		E		F		
		Item #	Lbs.	Item #	Lbs.	Item #	Lbs.	Item #	Lbs.	Item #	Lbs.	
SIZE & MATERIAL	12" x 18"	Nylon	035769	.10	-	-	-	-	-	-	-	
	2' x 3'	Nylon	033794	.25	033811	.25	033833	.25	035902	.25	033854	.25
	3' x 5'	Nylon	033796	.45	033813	.45	033835	.45	035903	.45	033856	.45
	4' x 6'	Nylon	033797	.70	033814	.70	033836	.70	035904	.70	033857	.70
	5' x 8'	Nylon	033798	1.0	033815	1.0	033837	1.0	035905	1.0	033858	1.0
	6' x 10'	Nylon	035199	1.8	035200	1.8	-	-	035906	1.8	035204	1.8
	3' x 5'	E-Poly	-	-	-	-	033834	.27	-	-	033855	.27



		SPAIN (NO SEAL)		SRI LANKA (UN)		SUDAN (UN)		SURINAME (UN/OAS)		SWAZILAND/ESWATINI (UN)		
PRICE CATEGORY		A		E		D		E		E		
		Item #	Lbs.	Item #	Lbs.	Item #	Lbs.	Item #	Lbs.	Item #	Lbs.	
SIZE & MATERIAL	12" x 18"	Nylon	033872	.10	-	-	-	-	-	-	-	
	2' x 3'	Nylon	033873	.25	033886	.25	033903	.25	033921	.25	033939	.25
	3' x 5'	Nylon	033874	.45	033888	.45	033905	.45	033923	.45	033941	.45
	4' x 6'	Nylon	033875	.70	033889	.70	033906	.70	033924	.70	033942	.70
	5' x 8'	Nylon	033876	1.0	033890	1.0	033907	1.0	033925	1.0	033943	1.0
	6' x 10'	Nylon	035203	1.8	035205	1.8	035210	1.8	035211	1.8	035212	1.8



		SWEDEN (UN)		SWITZERLAND (UN)		SYRIA (UN)		TAHITI		TAIWAN		
PRICE CATEGORY		A		B		C		A		C		
		Item #	Lbs.	Item #	Lbs.	Item #	Lbs.	Item #	Lbs.	Item #	Lbs.	
SIZE & MATERIAL	2' x 3'	Nylon	033960	.25	033986	.25	034005	.25	034022	.25	034038	.25
	3' x 5'	Nylon	033962	.45	033988	.45	034007	.45	034023	.45	034040	.45
	4' x 6'	Nylon	033963	.70	033989	.70	034008	.70	034024	.70	034041	.70
	5' x 8'	Nylon	033964	1.0	033990	1.0	034009	1.0	034025	1.0	034042	1.0
	6' x 10'	Nylon	035213	1.8	035214	1.8	035215	1.8	035216	1.8	035217	1.8
	3' x 5'	E-Poly	033961	.27	033987	.27	-	-	-	-	-	-

### FLAGS OF THE WORLD OUTDOOR PRICE GUIDE

PRICE CATEGORY		A - WORLD		B - WORLD		C - WORLD		D - WORLD		E - WORLD		F - WORLD		
QUANTITY		1-5	6+	1-5	6+	1-5	6+	1-5	6+	1-5	6+	1-5	6+	
SIZE & MATERIAL	12" x 18"	Nylon	\$16.10	\$14.40	\$17.00	\$15.60	\$18.80	\$17.00	\$20.70	\$18.60	\$20.70	\$18.60	\$20.70	\$18.60
	2' x 3'	Nylon	27.80	25.30	34.80	31.00	40.40	36.60	45.50	41.10	48.60	42.80	61.80	55.50
	3' x 5'	Nylon	37.50	33.50	55.50	50.50	64.00	56.50	65.00	58.50	74.50	67.50	85.50	76.00
	4' x 6'	Nylon	52.00	46.50	89.00	80.50	93.50	84.00	97.00	88.50	107.00	96.00	119.50	107.00
	5' x 8'	Nylon	80.00	77.00	115.00	111.00	130.00	125.00	132.00	126.00	151.00	146.00	161.00	150.00
	6' x 10'	Nylon	130.00	-	212.00	-	239.00	-	260.00	-	298.00	-	333.00	-
	3' x 5'	E-Poly	30.00	26.50	30.00	26.50	30.00	26.50	30.00	26.50	30.00	26.50	30.00	26.50



		TAJIKISTAN (UN)		TANZANIA (UN)		THAILAND (UN)		TIBET		TOGO (UN)		
PRICE CATEGORY		D		D		A		F		E		
		Item #	Lbs.	Item #	Lbs.	Item #	Lbs.	Item #	Lbs.	Item #	Lbs.	
SIZE & MATERIAL	2' x 3'	Nylon	034057	.25	034074	.25	034091	.25	-	-	034113	.25
	3' x 5'	Nylon	034059	.45	034076	.45	034093	.45	-	-	034115	.45
	4' x 6'	Nylon	034060	.70	034077	.70	034094	.70	-	-	034116	.70
	5' x 8'	Nylon	034061	1.0	034078	1.0	034095	1.0	-	-	034117	1.0
	6' x 10'	Nylon	035218	1.8	035219	1.8	035220	1.8	-	-	035221	1.8
	3' x 5'	E-Poly	-	-	-	-	034092	.27	034108	.27	-	-



		TONGA (UN)		TRINIDAD & TOBAGO (UN/OAS)		TUNISIA (UN)		TURKEY (UN)		TURKMENISTAN (UN)		
PRICE CATEGORY		C		C		D		D		E		
		Item #	Lbs.	Item #	Lbs.	Item #	Lbs.	Item #	Lbs.	Item #	Lbs.	
SIZE & MATERIAL	12" x 18"	Nylon	-	-	035774	.10	-	-	035775	.10	-	-
	2' x 3'	Nylon	034130	.25	034150	.25	034169	.25	034187	.25	034205	.25
	3' x 5'	Nylon	034132	.45	034152	.45	034171	.45	034189	.45	034206	.45
	4' x 6'	Nylon	034133	.70	034153	.70	034172	.70	034190	.70	034207	.70
	5' x 8'	Nylon	034134	1.0	034154	1.0	034173	1.0	034191	1.0	034208	1.0
	6' x 10'	Nylon	035222	1.8	035223	1.8	035224	1.8	035225	1.8	-	-
	3' x 5'	E-Poly	-	-	-	-	-	-	034188	.27	-	-



		TURKS & CAICOS		TUVALU (UN)		UGANDA (UN)		UKRAINE (UN)		UNITED ARAB EMIRATES (UN)		
PRICE CATEGORY		F		E		F		A		B		
		Item #	Lbs.	Item #	Lbs.	Item #	Lbs.	Item #	Lbs.	Item #	Lbs.	
SIZE & MATERIAL	12" x 18"	Nylon	035776	.10	-	-	-	-	-	-	-	
	2' x 3'	Nylon	034219	.25	035818	.25	034244	.25	034262	.25	034279	.25
	3' x 5'	Nylon	034221	.45	034237	.45	034246	.45	034264	.45	034281	.45
	4' x 6'	Nylon	034222	.70	035777	.70	034247	.70	034265	.70	034282	.70
	5' x 8'	Nylon	034223	1.0	035778	1.0	034248	1.0	034266	1.0	034283	1.0
	6' x 10'	Nylon	035227	1.8	035783	1.8	035228	1.8	035230	1.8	035232	1.8

FLAGS OF THE WORLD OUTDOOR PRICE GUIDE

PRICE CATEGORY		A - WORLD		B - WORLD		C - WORLD		D - WORLD		E - WORLD		F - WORLD		
QUANTITY		1-5	6+	1-5	6+	1-5	6+	1-5	6+	1-5	6+	1-5	6+	
SIZE & MATERIAL	12" x 18"	Nylon	\$16.10	\$14.40	\$17.00	\$15.60	\$18.80	\$17.00	\$20.70	\$18.60	\$20.70	\$18.60	\$20.70	\$18.60
	2' x 3'	Nylon	27.80	25.30	34.80	31.00	40.40	36.60	45.50	41.10	48.60	42.80	61.80	55.50
	3' x 5'	Nylon	37.50	33.50	55.50	50.50	64.00	56.50	65.00	58.50	74.50	67.50	85.50	76.00
	4' x 6'	Nylon	52.00	46.50	89.00	80.50	93.50	84.00	97.00	88.50	107.00	96.00	119.50	107.00
	5' x 8'	Nylon	80.00	77.00	115.00	111.00	130.00	125.00	132.00	126.00	151.00	146.00	161.00	150.00
	6' x 10'	Nylon	130.00	-	212.00	-	239.00	-	260.00	-	298.00	-	333.00	-
	3' x 5'	E-Poly	30.00	26.50	30.00	26.50	30.00	26.50	30.00	26.50	30.00	26.50	30.00	26.50

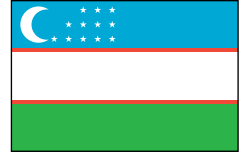

			UNITED KINGDOM (UN)		UNITED NATIONS		U.S.S.R. (1955-1991)		URUGUAY (UN/OAS)		UZBEKISTAN (UN)	
PRICE CATEGORY			D		B		C		E		E	
			Item #	Lbs.	Item #	Lbs.	Item #	Lbs.	Item #	Lbs.	Item #	Lbs.
SIZE & MATERIAL	2' x 3'	Nylon	034300	.25	034320	.25	034338	.25	034359	.25	034377	.25
	3' x 5'	Nylon	034302	.45	034322	.45	034340	.45	034361	.45	034379	.45
	4' x 6'	Nylon	034303	.70	034323	.70	034341	.70	034362	.70	034380	.70
	5' x 8'	Nylon	034304	1.0	034324	1.0	034342	1.0	034363	1.0	034381	1.0
	6' x 10'	Nylon	035229	1.8	035231	1.8	035234	1.8	035233	1.8	035235	1.8
	3' x 5'	E-Poly	034301	.27	034321	.27	034339	.27	-	-	-	-

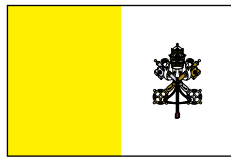

			VANUATU (UN)		VATICAN CITY (PAPAL)*		VENEZUELA w/SEAL (UN/OAS)		VENEZUELA (NO SEAL)		VIETNAM (UN)	
PRICE CATEGORY			E		E		F		D		C	
			Item #	Lbs.	Item #	Lbs.	Item #	Lbs.	Item #	Lbs.	Item #	Lbs.
SIZE & MATERIAL	12" x 18"	Nylon	-	-	-	-	-	-	034450	.10	-	-
	2' x 3'	Nylon	034394	.25	034412	.25	034431	.25	034451	.25	034466	.25
	3' x 5'	Nylon	034396	.45	034414	.45	034433	.45	034452	.45	034468	.45
	4' x 6'	Nylon	034397	.70	034415	.70	034434	.70	034453	.70	034469	.70
	5' x 8'	Nylon	034398	1.0	034416	1.0	034435	1.0	034454	1.0	034470	1.0
	6' x 10'	Nylon	-	-	035237	1.8	035239	1.8	035238	1.8	035240	1.8
	3' x 5'	E-Poly	-	-	-	-	034432	.27	-	-	-	-

\*See page 4 for pole hem and fringe add-ons.

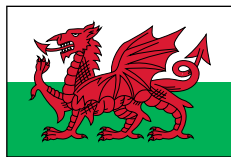

			SOUTH VIETNAM		WALES		WORLD CO-OP		YEMEN (UN)		ZAMBIA (UN)	
PRICE CATEGORY			B		D		C		A		E	
			Item #	Lbs.	Item #	Lbs.	Item #	Lbs.	Item #	Lbs.	Item #	Lbs.
SIZE & MATERIAL	2' x 3'	Nylon	034483	.25	034504	.25	034543	.25	034560	.25	034594	.25
	3' x 5'	Nylon	034485	.45	034506	.45	034544	.45	034561	.45	034596	.45
	4' x 6'	Nylon	034486	.70	034507	.70	034545	.70	034562	.70	034597	.70
	5' x 8'	Nylon	034487	1.0	034508	1.0	034546	1.0	034563	1.0	034598	1.0
	6' x 10'	Nylon	035241	1.8	035242	1.8	035244	1.8	035245	1.8	035247	1.8
	3' x 5'	E-Poly	-	-	034505	.27	-	-	-	-	-	-

## FLAGS OF THE WORLD OUTDOOR PRICE GUIDE

PRICE CATEGORY			A - WORLD		B - WORLD		C - WORLD		D - WORLD		E - WORLD		F - WORLD	
QUANTITY			1-5	6+	1-5	6+	1-5	6+	1-5	6+	1-5	6+	1-5	6+
SIZE & MATERIAL	12" x 18"	Nylon	\$16.10	\$14.40	\$17.00	\$15.60	\$18.80	\$17.00	\$20.70	\$18.60	\$20.70	\$18.60	\$20.70	\$18.60
	2' x 3'	Nylon	27.80	25.30	34.80	31.00	40.40	36.60	45.50	41.10	48.60	42.80	61.80	55.50
	3' x 5'	Nylon	37.50	33.50	55.50	50.50	64.00	56.50	65.00	58.50	74.50	67.50	85.50	76.00
	4' x 6'	Nylon	52.00	46.50	89.00	80.50	93.50	84.00	97.00	88.50	107.00	96.00	119.50	107.00
	5' x 8'	Nylon	80.00	77.00	115.00	111.00	130.00	125.00	132.00	126.00	151.00	146.00	161.00	150.00
	6' x 10'	Nylon	130.00	-	212.00	-	239.00	-	260.00	-	298.00	-	333.00	-
3' x 5'	E-Poly	30.00	26.50	30.00	26.50	30.00	26.50	30.00	26.50	30.00	26.50	30.00	26.50	

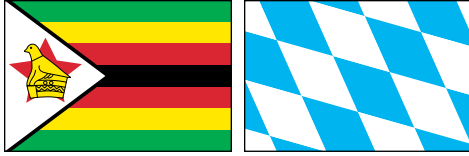

**ZIMBABWE (UN)**      **BAVARIA (NO LIONS)**

PRICE CATEGORY		E		E		
		Item #	Lbs.	Item #	Lbs.	
SIZE & MATERIAL	2' x 3'	Nylon	034611	.25	035864	.25
	3' x 5'	Nylon	034613	.45	034771	.45
	4' x 6'	Nylon	034614	.70	034772	.70
	5' x 8'	Nylon	034615	1.0	034773	1.0
	6' x 10'	Nylon	035248	1.8	-	-

**FLAGS OF THE WORLD OUTDOOR PRICE GUIDE**

PRICE CATEGORY		A - WORLD		B - WORLD		C - WORLD		D - WORLD		E - WORLD		F - WORLD		
QUANTITY		1-5	6+	1-5	6+	1-5	6+	1-5	6+	1-5	6+	1-5	6+	
SIZE & MATERIAL	12" x 18"	Nylon	\$16.10	\$14.40	\$17.00	\$15.60	\$18.80	\$17.00	\$20.70	\$18.60	\$20.70	\$18.60	\$20.70	\$18.60
	2' x 3'	Nylon	27.80	25.30	34.80	31.00	40.40	36.60	45.50	41.10	48.60	42.80	61.80	55.50
	3' x 5'	Nylon	37.50	33.50	55.50	50.50	64.00	56.50	65.00	58.50	74.50	67.50	85.50	76.00
	4' x 6'	Nylon	52.00	46.50	89.00	80.50	93.50	84.00	97.00	88.50	107.00	96.00	119.50	107.00
	5' x 8'	Nylon	80.00	77.00	115.00	111.00	130.00	125.00	132.00	126.00	151.00	146.00	161.00	150.00
	6' x 10'	Nylon	130.00	-	212.00	-	239.00	-	260.00	-	298.00	-	333.00	-
	3' x 5'	E-Poly	30.00	26.50	30.00	26.50	30.00	26.50	30.00	26.50	30.00	26.50	30.00	26.50

FLAG ETIQUETTE

## CONDUCT DURING HOISTING, LOWERING, OR PASSING OF THE AMERICAN FLAG

- When the American Flag is raised, lowered, or flown in a parade or review, all are asked to show the highest respect.
- Those in uniform – Render a proud military salute.
- Members of the Armed Forces and Veterans (not in uniform) – May also salute the flag in honor.
- All other persons –
  - Face the flag and stand tall at attention.
  - Place your right hand over your heart as a sign of respect.
  - If wearing a non-uniform headdress, remove it and hold it at your left shoulder, with your hand over your heart.
- Citizens of other nations – Kindly stand at attention as a gesture of respect.
- When the flag moves past in a parade or procession, render this tribute at the moment the flag passes before you.

**HONOR OUR FLAG. HONOR OUR FREEDOM.**

3' X 5' OUTDOOR NYLON FLAGS



**ALBERTA**

Item #	1-5	6+	Lbs.
034728	\$85.50	\$76.00	.45



**BRITISH COLUMBIA**

Item #	1-5	6+	Lbs.
034729	\$74.50	\$67.50	.45



**MANITOBA**

Item #	1-5	6+	Lbs.
034730	\$85.50	\$76.00	.45



**NEW BRUNSWICK**

Item #	1-5	6+	Lbs.
034731	\$74.50	\$67.50	.45

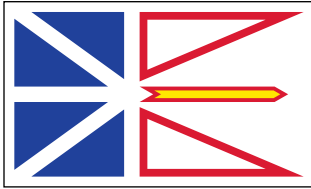

**NEWFOUNDLAND**

Item #	1-5	6+	Lbs.
034732	\$74.50	\$67.50	.45

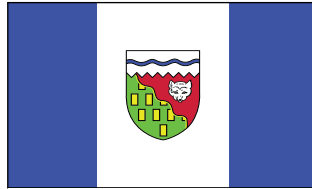

**NW TERRITORIES**

Item #	1-5	6+	Lbs.
034733	\$85.50	\$76.00	.45

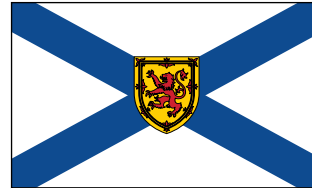

**NOVA SCOTIA**

Item #	1-5	6+	Lbs.
034734	\$74.50	\$67.50	.45

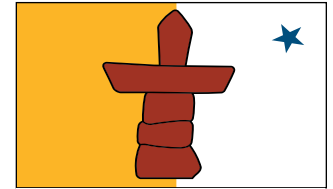

**NUNAVAT**

Item #	1-5	6+	Lbs.
034735	\$74.50	\$67.50	.45

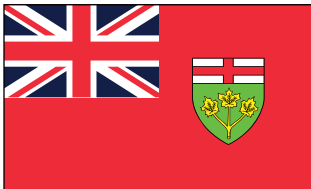

**ONTARIO**

Item #	1-5	6+	Lbs.
034736	\$85.50	\$76.00	.45

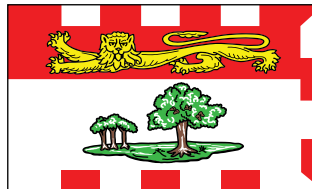

**PRINCE EDWARD ISLAND**

Item #	1-5	6+	Lbs.
034737	\$85.50	\$76.00	.45

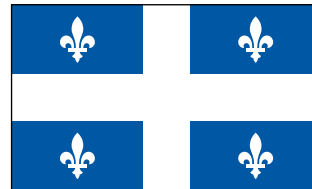

**QUEBEC**

Item #	1-5	6+	Lbs.
034738	\$74.50	\$67.50	.45

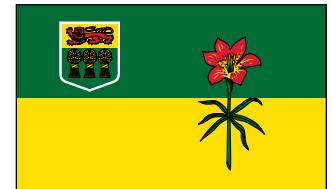

**SASKATCHEWAN**

Item #	1-5	6+	Lbs.
034739	\$74.50	\$67.50	.45



**THE YUKON**

Item #	1-5	6+	Lbs.
034740	\$74.50	\$67.50	.45

## CHRISTIAN FLAGS

### DELUXE SETS INCLUDE:

- Fully sewn, gold fringed nylon flag with appliqued cross
- Gold cord & tassel
- 2-piece pole with brass screw joint
- Brass plated metal Passion Cross
- Gold anodized Endura™ floor stand

### DELUXE NYLON SETS WITH OAK POLES

Item #	Model	Flag Size	Pole Size	Cross Height x Width	Stand Dia.	Price	
040000	FWS-300	2' x 3'	7' x 15/16"	6-1/2" x 4-1/4"	9"	\$255.00	13
040001	FWS-400	2-1/2' x 4'	7' x 15/16"	6-1/2" x 4-1/4"	9"	300.00	13
040002	FWS-301	3' x 5'	8' x 1-1/8"	7-1/2" x 5"	12"	310.00	22
040004	FWS-46	4' x 6'	9' x 1-1/8"	7-1/2" x 5"	12"	350.00	23

### DELUXE NYLON SETS WITH GOLD ALUMINUM POLES

Item #	Model	Flag Size	Pole Size	Cross Height x Width	Stand Dia.	Price	
040016	FSA-300	2' x 3'	7' x 1"	6-1/2" x 4-1/4"	9"	\$255.00	12
040017	FSA-400	2-1/2' x 4'	7' x 1"	6-1/2" x 4-1/4"	9"	285.00	12
040018	FSA-301	3' x 5'	8' x 1-1/8"	7-1/2" x 5"	12"	320.00	20
040020	FSA-46	4' x 6'	9' x 1-1/8"	7-1/2" x 5"	12"	345.00	21

### NYLON INDOOR WITH GOLD FRINGE

With pole hem & mounting tabs

Item #	Model	Size	1-5	6+	Lbs.
040066	FN-6	2' x 3'	\$73.70	\$69.20	.30
040067	FN-10	2-1/2' x 4'	87.70	82.30	.45
040068	FN-4	3' x 5'	99.50	93.40	.60
040070	FNC-46	4' x 6'	134.50	123.00	.95

### NYLON INDOOR – NO FRINGE

With pole hem & mounting tabs

Item #	Size	1-5	6+	Lbs.
040080	2' x 3'	\$57.20	\$52.50	.20
040081	2-1/2' x 4'	64.80	60.70	.30
040082	3' x 5'	76.20	70.40	.40
040084	4' x 6'	107.50	97.50	.65



### NYLON OUTDOOR

With canvas header & brass grommets

Item #	Size	1-5	6+	Lbs.
040094	2' x 3'	\$40.20	\$35.50	.25
040096	2-1/2' x 4'	47.80	43.70	.35
040098	3' x 5'	54.70	48.90	.45
040101	4' x 6'	83.50	73.50	.70
040103	5' x 8'	105.50	95.00	1.0
040105	6' x 10'	150.00	147.00	2.0



## ISRAEL FLAGS

### DELUXE SETS INCLUDE:

- Gold fringed nylon flag
- Gold cord & tassel
- 2-piece pole with brass screw joint
- Brass plated metal Star of David
- Gold anodized Endura™ floor stand

See [pages 41](#) for individual Israel flag options.

### DELUXE NYLON SETS WITH OAK POLES

Item #	Model	Flag Size	Pole Size	Star Height x Width	Stand Dia.	Price	Lbs.
040013	ZW-20	3' x 5'	8' x 1-1/8"	6-3/4" x 4-3/4"	12"	\$335.00	22
040015	ZW-46	4' x 6'	9' x 1-1/8"	6-3/4" x 4-3/4"	12"	390.00	23

### DELUXE NYLON SETS WITH GOLD ALUMINUM POLES

Item #	Model	Flag Size	Pole Size	Star Height x Width	Stand Dia.	Price	Lbs.
040033	ZA-20	3' x 5'	8' x 1-1/8"	6-3/4" x 4-3/4"	12"	\$350.00	20
040035	ZA-46	4' x 6'	9' x 1-1/8"	6-3/4" x 4-3/4"	12"	390.00	21



## UNITED METHODIST FLAGS

### DELUXE SETS INCLUDE:

- Gold fringed nylon flag
- Gold cord & tassel
- 2-piece pole with brass screw joint
- Brass plated metal Passion Cross
- Gold anodized Endura™ floor stand

### DELUXE NYLON SETS WITH OAK POLES

Item #	Flag Size	Pole Size	Cross Height x Width	Stand Dia.	Price	Lbs.
040129	3' x 5'	8' x 1-1/8"	7-1/2" x 5"	12"	\$330.00	22
040130	4' x 6'	9' x 1-1/8"	7-1/2" x 5"	12"	405.00	23

### DELUXE NYLON SETS WITH GOLD ALUMINUM POLES

Item #	Flag Size	Pole Size	Cross Height x Width	Stand Dia.	Price	Lbs.
040131	3' x 5'	8' x 1-1/8"	7-1/2" x 5"	12"	\$330.00	20
040132	4' x 6'	9' x 1-1/8"	7-1/2" x 5"	12"	405.00	21



### INDOOR WITH GOLD FRINGE

With pole hem & mounting tabs

Item #	Size	1-5	6+	Lbs.
040133	3' x 5'	\$106.40	\$100.00	.45
040161	4' x 6'	139.50	132.00	.70

### INDOOR – NO FRINGE

With pole hem & mounting tabs

Item #	Size	1-5	6+	Lbs.
040135	3' x 5'	\$84.90	\$78.50	.40
040162	4' x 6'	115.50	108.00	.55

### OUTDOOR

With canvas header & brass grommets

Item #	Size	1-5	6+	Lbs.
040137	3' x 5'	\$63.40	\$57.00	.45
040138	4' x 6'	91.50	84.00	.70
040167	5' x 8'	140.50	129.00	1

**PAPAL FLAGS**

**DELUXE SETS INCLUDE:**

- Gold fringed nylon flag
- Gold cord & tassel
- 2-piece pole with brass screw joint
- Brass plated metal Passion Cross
- Gold anodized Endura™ floor stand

See [page 50](#) for individual Papal flag options.

**DELUXE NYLON SETS WITH OAK POLES**

Item #	Model	Flag Size	Pole Size	Cross Height x Width	Stand Dia.	Price	Lbs.
040006	FPW-1	3' x 5'	8' x 1-1/8"	7-1/2" x 5"	12"	\$360.00	22
040008	FPW-46	4' x 6'	9' x 1-1/8"	7-1/2" x 5"	12"	415.00	23

**DELUXE NYLON SETS WITH GOLD ALUMINUM POLES**

Item #	Model	Flag Size	Pole Size	Cross Height x Width	Stand Dia.	Price	Lbs.
040024	FPA-1	3' x 5'	8' x 1-1/8"	7-1/2" x 5"	12"	\$360.00	20
040026	FPA-46	4' x 6'	9' x 1-1/8"	7-1/2" x 5"	12"	415.00	21



**ADDITIONAL RELIGIOUS FLAGS**



**EPISCOPAL NYLON OUTDOOR FLAGS**

With canvas header & brass grommets

Item #	Size	1-5	6+	Lbs.
040108	3' x 5'	\$87.50	\$81.50	.45
040110	4' x 6'	123.00	110.50	.70
040111	5' x 8'	152.50	149.00	1.0



**BUDDHIST NYLON OUTDOOR FLAGS**

With canvas header & brass grommets

Item #	Size	1-5	6+	Lbs.
040157	3' x 5'	\$63.40	\$57.00	.45

# INDOOR & PARADE ACCESSORIES

## METAL FLYING EAGLES

For indoor use only.

See [page 146](#) for outdoor metal flying eagles.

Model	Color	Ht.	Wing Span	With Ferrule (For Oak Poles)			No Ferrule (For Poles With Top Adapter)		
				Item #	Price	Lbs.	Item #	Price	Lbs.
E-6	Gold	5"	6-1/2"	050000	\$59.00	1.0	050012	\$50.50	.85
E-8	Gold	7"	8-1/4"	050002	73.00	1.4	050014	66.00	1.2



## METAL PERCHED EAGLES

Model	Color	Ht.	Wing Span	With Ferrule (For Oak Poles)			No Ferrule (For Poles With Top Adapter)		
				Item #	Price	Lbs.	Item #	Price	Lbs.
E-5	Gold	5"	5"	050018	\$63.00	.80	050026	\$59.00	.70
E-7	Gold	6-3/4"	7-1/2"	050020	66.00	1.8	050028	63.00	1.7



## HI-IMPACT ABS STYRENE PERCHED EAGLE ORNAMENT

With a shiny multi-layer gold plated finish this eagle is extremely durable. Comes with gold mounting screw. This ABS styrene perched eagle can only be mounted on our oak finished wood poles.

Model	Item #	Color	Ht.	Wing Span	1-11	12+	Lbs.
E-7S	050537	Gold	8-1/4"	7"	\$37.00	\$35.50	.65



## PLASTIC SLIP FIT EAGLES

For Pole	Ht.	Wing Span	Lbs.	Brass Plated		Gold Gilt	
				Item #	Price	Item #	Price
3/4" Aluminum	3-1/4"	4-1/4"	.05	050031	\$5.18	-	-
3/4" Steel	3-1/4"	4-1/4"	.05	050032	5.18	050035	\$1.78
1" Aluminum	3-1/4"	4-1/4"	.05	-	-	050036	1.78



Brass Plated Gold



Gold Gilt Finish



### Standard Ferrule

Where indicated on this page, our ornaments can be used with a ferrule. A ferrule is for indoor use on our oak finished wood poles. When using an ornament for an indoor aluminum pole with a top adapter already installed, a ferrule is not required.

**METAL PASSION CROSS**

Model	Color	Ht.	Width	With Ferrule (For Oak Poles)			No Ferrule (For Poles With Top Adapter)		
				Item #	Price	Lbs.	Item #	Price	Lbs.
R-30	Gold	7-1/2"	5"	050039	\$64.00	.85	050047	\$54.00	.70



**METAL STAR OF DAVID**

Model	Color	Ht.	Width	With Ferrule (For Oak Poles)			No Ferrule (For Poles With Top Adapter)		
				Item #	Price	Lbs.	Item #	Price	Lbs.
SD-1	Gold	6-3/4"	4-3/4"	050073	\$71.50	.85	050077	\$63.50	.70



**METAL ROUND SPEAR**

Model	Color	Ht.	Width	With Ferrule (For Oak Poles)			No Ferrule (For Poles With Top Adapter)		
				Item #	Price	Lbs.	Item #	Price	Lbs.
S-105	Gold	8"	1-3/4"	050087	\$82.00	.80	050099	\$74.50	.68



**METAL FLAT SPEARS**

Model	Color	Ht.	Width	With Ferrule (For Oak Poles)			No Ferrule (For Poles With Top Adapter)		
				Item #	Price	Lbs.	Item #	Price	Lbs.
S-102	Gold	7-1/2"	1-3/4"	050103	\$74.50	.55	050111	\$67.50	.50
S-102	Silver	7-1/2"	1-3/4"	050104	74.50	.65	050112	67.50	.50



**METAL ARMY SPEARS**

Model	Color	Ht.	Width	With Ferrule (For Oak Poles)			No Ferrule (For Poles With Top Adapter)		
				Item #	Price	Lbs.	Item #	Price	Lbs.
S-100	Gold	8-1/4"	3-1/2"	050115	\$82.00	.70	050119	\$74.50	.70
S-100	Silver	8-1/4"	3-1/2"	050116	82.00	.70	050120	74.50	.70



050115 & 050116:  
With removable spear top

050119 & 050120:  
One piece construction

**HI-IMPACT ABS STYRENE SPEAR ORNAMENT**

With a shiny multi-layer gold plated finish this spear is extremely durable. Comes with gold mounting screw. **This ABS styrene spear can only be mounted on our oak finished wood poles.**

Item #	Color	Height	Width	1-11	12+	Lbs.
050548	Gold	8"	2-1/4"	\$25.00	\$23.50	.12



# INDOOR & PARADE ACCESSORIES

## METAL PARADE BALLS

Model	Color	Ht.	Width	With Ferrule (For Oak Poles)			No Ferrule (For Poles With Top Adapter)		
				Item #	Price	Lbs.	Item #	Price	Lbs.
PB-3	Gold	4-1/4"	3"	050127	\$62.50	.80	050131	\$50.50	.70
PB-3	Silver	4-1/4"	3"	050128	62.50	.80	050132	50.50	.58



## VINYL SLIP FIT BALLS

Gold only



Model	Item #	Fits Outside		Ht.	Dia.	Price	Lbs.
		Pole Dia.	Ht.				
VB1	050140	1"	2-1/8"	1-3/4"	\$2.94	.05	
VB150	050142	1-1/2"	3-1/4"	2-1/2"	4.48	.10	
VB158	050143	1-5/8"	3-1/4"	2-1/2"	4.48	.10	
VB175	050144	1-3/4"	4-1/4"	3-1/2"	11.96	.20	

## PLASTIC SLIP FIT BALL

Gold only



Model	Item #	Fits Outside			Price	Lbs.
		Pole Dia.	Ht.	Dia.		
GPB-1	050145	1"	1-3/8"	1-5/8"	\$2.78	.05

## METAL TEXAS STAR

Model	Color	Ht.	Width	With Ferrule (For Oak Poles)			No Ferrule (For Poles With Top Adapter)		
				Item #	Price	Lbs.	Item #	Price	Lbs.
TS-1	Gold	6-3/4"	4-1/4"	050150	\$71.50	.95	050154	\$60.50	.80



## METAL MAPLE LEAF

Model	Color	Ht.	Width	With Ferrule (For Oak Poles)			No Ferrule (For Poles With Top Adapter)		
				Item #	Price	Lbs.	Item #	Price	Lbs.
ML-1	Gold	5-1/4"	4"	050167	\$74.00	.70	050171	\$67.00	.80



## PLASTIC SLIP FIT ACORNS



Model	Item #	Color	Fits Outside		Price	Lbs.
			Pole Dia.	Ht.		
PA-12	050183	Gold	1/2"	1-3/8"	1"	\$2.40 .02
PA-34	050184	Gold	3/4"	2"	1-1/2"	4.30 .03
PA-1	050186	Gold	1"	2-3/8"	2"	4.50 .04
PA-1S	050566	Silver	1"	2-3/8"	2"	4.50 .04

## SOLID BRASS SLIP FIT ACORNS



Item #	Fits Outside			Price	Lbs.
	Pole Dia.	Ht.	Width		
050522	1"	2-3/8"	2"	\$14.50	.07

Floor Stands on pages 59-60 are not intended for outdoor display. Floor stand weights are for shipping purposes.

## INDOOR & PARADE ACCESSORIES

ORNAMENTS

### SLIP FIT WOOD BALL

Natural color with lacquer finish



Model	Item #	Fits Outside			Price	Lbs.
		Pole Dia.	Ht.	Width		
SFB	050166	15/16" or 1"	2-1/4"	1-3/4"	\$4.60	.09

### METAL AWARD RIBBON POLE RINGS

Fits over our wood poles with ferrule or our aluminum poles with top adapter already installed. Outside diameter is 3-1/2". Inside diameter is 7/8".

Army Spear, ferrule & pole are sold separately and are not included in the price.

Item #	Color	Price	Lbs.
050148	Gold	\$63.50	.20
050149	Silver	57.00	.20

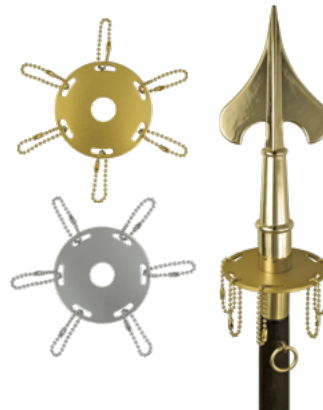

### METAL POINTED BOTTOM FERRULES

Fits a 13/16" outside pole diameter and is 5-1/4" long. For use with our Guidon poles.

Model	Item #	Color	Price	Lbs.
BF-1	050146	Gold	\$76.00	.70
BF-2	050147	Silver	91.00	.70



See [Page 104](#) For Clear Plastic EZ-Mount™ Flag Rings

### ENDURA™ FLOOR STANDS

Our most popular floor stand. Comes complete with weighted inner core and brilliant anodized finish.

Model	For Pole Dia.	Dia.	Ht.	Lbs.	Item #	Gold		Silver		
						1-11	12+	1-11	12+	
E200-1516	15/16"	9"	4-1/2"	7.7	050187	\$72.00	\$69.50	050194	\$72.00	\$69.50
E200-1	1"	9"	4-1/2"	7.7	050188	74.00	71.50	050195	74.00	71.50
E100-1516	15/16"	12"	6"	13.5	—	—	—	050196	98.50	96.00
E100-1	1"	12"	6"	13.5	050190	98.50	96.00	050197	98.50	96.00
E100-118	1-1/8"	12"	6"	13.5	050191	98.50	96.00	050198	98.50	96.00
E100-114	1-1/4"	12"	6"	13.5	050192	98.50	96.00	050199	98.50	96.00
E100-112	1-1/2"	12"	6"	13.5	050193	98.50	96.00	050200	98.50	96.00



### AMERICAN BEAUTY FLOOR STANDS

These cast stands are designed to complement any flag set. Easily movable, these are the most practical stands for general use. See [page 64](#) for our Guidon stand.

\* Supplied with adapter sleeves.

Model	For Pole Dia.	Dia.	Ht.	Lbs.	Item #	Gold		Silver		
						1-11	12+	1-11	12+	
B101-VAR*	15/16", 1"	9"	5-1/2"	7	050568	\$64.00	\$61.50	050569	\$64.00	\$61.50
B100-VAR*	1", 1-1/8", 1-1/4"	12"	6"	13	050540	115.00	111.50	050541	115.00	111.50
B100-138	1-3/8"	12"	6"	13	050205	113.50	110.50	050210	113.50	110.50



FLOOR STANDS



### U.S. FLOOR STANDS

Comes complete with gold anodized aluminum outer shell formed around a rugged, cast inner shell.

- Model US-101
- Weight: 20.3 lbs.

Item #	Color	For Pole Dia.	Dia.	Ht.	1-11	12+
050213	Gold	1-1/8"	12"	5-1/2"	\$217.00	\$193.00
050214	Gold	1-1/4"	12"	5-1/2"	217.00	193.00

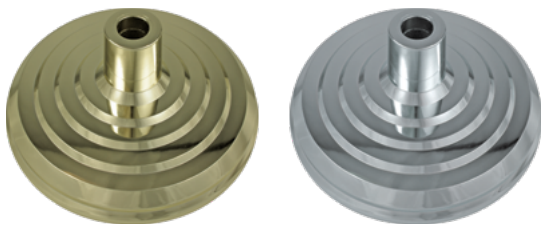

### REGENT FLOOR STANDS

Tough, beautiful plated plastic stand complete with adapter sleeves to accommodate various pole diameters.

- Model PMB-M
- Weight: 2.7 lbs., approx. 10 lbs. when filled with sand (not included)

Item #	Color	For Pole Dia.	Dia.	Ht.	1-11	12+
050217	Gold	1", 1-1/8", 1-1/4"	12"	5-1/2"	\$76.00	\$70.00
050218	Silver	1", 1-1/8", 1-1/4"	12"	5-1/2"	76.00	70.00

### PORTABLE FLOOR STAND

Made of strong, durable polymer plastic. When completely folded this stand measures only 24" x 2-1/8". Color is rich dark brown to compliment any décor. Supplied with adapter sleeves to accommodate various pole diameters.

Model	Item #	For Pole Dia.	Stand Ht.	1-23	24+	Lbs.
PFS	050221	1", 1-1/8", 1-1/4"	5-3/4"	\$44.00	\$34.50	1.5

### THREE HOLE FLOOR STANDS

This cast stand creates a display of 1, 2, or 3 flags. Supplied with adapter sleeves to accommodate various pole diameters.

Model	Item #	Color	For Pole Dia.	Dia.	Ht.	Lbs.	1-11	12+
B-300	050211	Gold	1", 1-1/8", 1-1/4"	12"	5-1/2"	32.1	\$254.00	\$244.00
B-300	050212	Silver	1", 1-1/8", 1-1/4"	12"	5-1/2"	32.1	254.00	244.00



Floor Stands on pages 59-60 are not intended for outdoor display. Floor stand weights are for shipping purposes.



### FEDERAL FLOOR STANDS

Cast stand with universal bore. Supplied with adapter sleeves to accommodate various pole diameters.

- Model F-100
- Weight: 8.1 lbs.

Item #	Color	For Pole Dia.	Dia.	Ht.	1-11	12+
050215	Gold	1", 1-1/8", 1-1/4"	10-3/4"	5-1/2"	\$116.00	\$107.50
050216	Silver	1", 1-1/8", 1-1/4"	10-3/4"	5-1/2"	116.00	107.50

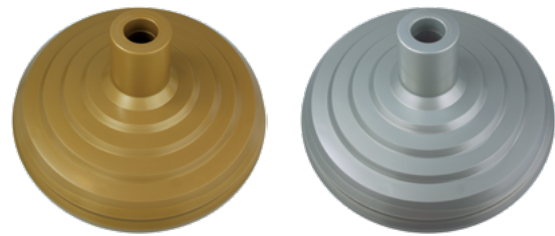

### VISCOUNT FLOOR STANDS

Plastic stand with color impregnated finish (not painted) complete with adapter sleeves to accommodate various pole diameters.

- Model PMB-P
- Weight: 3.5 lbs., approx. 10 lbs. when filled with sand (not included)

Item #	Color	For Pole Dia.	Dia.	Ht.	1-11	12+
050219	Gold	1", 1-1/8", 1-1/4"	12"	5-1/2"	\$60.50	\$52.00
050220	Silver	1", 1-1/8", 1-1/4"	12"	5-1/2"	60.50	52.00



**DELUXE ALUMINUM POLES**

The Ultimate in an Aluminum Pole

**POLE INCLUDES:**

- Top ornament adapter, cord & tassel ring, flag rings and capped bottom
- 2-piece poles have a precision machined solid brass screw joint

**AVAILABLE FINISHES:**

- 1" diameter poles are available in shiny bright-dipped gold anodized or silver mill finish
- 1-1/8" diameter poles are available in shiny bright-dipped gold anodized or shiny bright-dipped silver anodized

\* Compatible ornaments must not include spindle or ferrule.

Model	Ht.	Dia.	# of Sections	Lbs.	Item #	Gold		Item #	Silver	
						1-11	12+		1-11	12+
P-32	6'	1"	1	.90	050222	\$70.00	\$66.50	050240	\$58.00	\$54.00
P-33	6'	1"	2	1.1	050223	103.00	97.50	050241	88.50	84.00
P-34	6'	1-1/8"	1	1.4	050224	77.50	75.50	050242	77.50	75.50
P-35	6'	1-1/8"	2	1.5	050225	113.50	110.50	050243	113.50	110.50
P-36	7'	1"	1	1.1	050226	79.50	74.00	050244	70.00	66.50
P-37	7'	1"	2	1.2	050227	107.00	100.50	050245	103.00	97.50
P-38	7'	1-1/8"	1	1.6	050228	84.00	77.50	050246	84.00	77.50
P-46	7'	1-1/8"	2	1.7	050229	116.50	113.50	050247	116.50	113.50
P-39	8'	1"	1	1.2	050230	81.50	77.00	050248	79.50	74.00
P-40	8'	1"	2	1.3	050231	111.00	105.50	050249	107.00	100.50
P-41	8'	1-1/8"	1	1.8	050232	88.50	84.00	050250	88.50	84.00
P-47	8'	1-1/8"	2	1.9	050233	121.50	116.50	050251	121.50	116.50
P-42	9'	1"	2	1.5	050234	119.50	114.50	050252	111.00	105.50
P-48	9'	1-1/8"	2	2.1	050235	144.00	137.00	050253	144.00	137.00
P-44	10'	1"	2	1.6	050236	123.50	118.00	050254	119.50	114.50
P-45	10'	1-1/8"	2	2.3	050237	144.00	137.00	050255	144.00	137.00
P-43	11'	1"	2	1.7	050238	130.50	110.50	050256	123.50	118.00
P-49	11'	1-1/8"	2	2.5	050239	160.00	150.50	050257	160.00	150.50



\*Suggested Parade Ball Ornament (not included)

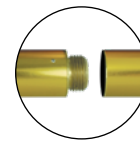

Joint Detail

**BUDGET ALUMINUM POLES**

Beauty & Economy

**POLE INCLUDES:**

- Gold plated plastic acorn with 3/4" poles
- Gold vinyl ball with 1" poles
- Two nylon flag ties
- 2-piece poles swedge together perfectly for a smooth finish

**AVAILABLE FINISHES:**

- Shiny gold anodized
- Silver mill

Model	Ht.	Dia.	# of Sections	Lbs.	Item #	Gold		Item #	Silver	
						1-11	12+		1-11	12+
BPA-3	6'	3/4"	1	.54	050258	\$35.50	\$32.00	050268	\$31.50	\$28.00
BPA-4	6'	3/4"	2	.54	-	-	-	050269	32.50	30.00
BPA-5	6'	1"	1	.81	050260	39.50	36.00	050270	35.50	32.00
BPA-2	6'	1"	2	.81	050261	41.50	39.00	050271	39.50	36.00
BPA-6	7'	1"	1	.95	050262	49.50	46.00	050272	41.50	39.00
BPA-7	7'	1"	2	.95	050263	46.50	44.50	050273	39.50	36.00
BPA-8	8'	1"	1	1.1	050264	55.50	51.00	050274	48.00	42.50
BPA-1	8'	1"	2	1.1	050265	54.00	50.50	050275	50.00	46.00
BPA-9	9'	1"	2	1.2	050266	60.00	54.00	050276	54.00	50.50
BPA-10	10'	1"	2	1.4	050267	63.50	60.00	050277	60.00	54.00



# INDOOR & PARADE ACCESSORIES

## POLES

### OAK FINISHED POLES

High Quality Grained Hardwood

**POLE INCLUDES:**

- Cord & tassel ring
- Precision machined solid brass screw joint

\* Compatible ornaments must include ferrule.

Model	Ht.	Dia.	# of Sections	Lbs.	Item #	with Brass Joint		with Chrome Joint		
						1-11	12+	Item #	1-11	12+
P-10	7'	15/16"	2	1.9	050278	\$83.00	\$79.00	050555	\$112.50	\$108.00
P-101	7'	1"	2	1.9	050279	85.50	81.50	050556	116.00	111.00
P-19	7'	1-1/8"	2	2.6	050280	107.00	100.50	050557	136.00	130.50
P-23	7'	1-1/4"	2	3.3	050281	107.00	100.50	050558	136.00	130.50
P-111	8'	1"	2	2.0	050283	93.00	90.00	050560	123.50	120.00
P-20	8'	1-1/8"	2	2.8	050284	109.50	105.00	050561	142.50	135.00
P-24	8'	1-1/4"	2	3.3	050285	109.50	105.00	050562	142.50	135.00
P-21	9'	1-1/8"	2	3.4	050286	123.50	116.00	050563	155.50	147.00
P-25	9'	1-1/4"	2	4.1	050287	123.50	116.00	050564	155.50	147.00



\*Suggested Eagle Ornament & Ferrule (not included)

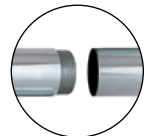

Joint Detail

### ALUMINUM MARCHING BAND POLES

**POLE INCLUDES:**

- 2-piece poles have a precision machined solid brass screw joint

**AVAILABLE FINISHES:**

- 1" diameter poles are available in shiny gold anodized or silver mill
- 1-1/8" diameter poles are available in shiny gold anodized or shiny silver anodized



\*Suggested Parade Ball Ornament - not included. For top ornament adapter only.

**With Top Ornament Adapter & Bottom Plug**

\* Compatible ornaments must not include spindle or ferrule.

Model	Ht.	Dia.	# of Sections	Lbs.	Item #	Gold		Silver		
						1-11	12+	Item #	1-11	12+
MP-12	6'	1"	2	1.1	050295	\$107.00	\$100.50	050307	\$100.50	\$96.00
MP-15	7'	1"	1	.99	050298	81.50	76.50	050310	70.50	66.50
MP-16	7'	1"	2	1.2	050299	119.50	114.50	050311	106.50	102.00
MP-19	8'	1"	1	1.2	050302	93.50	86.50	050314	83.00	79.00
MP-20	8'	1"	2	1.3	050303	127.00	122.00	050315	118.50	114.00
MP-21	8'	1-1/8"	1	1.8	050304	98.50	94.00	050316	98.50	94.00

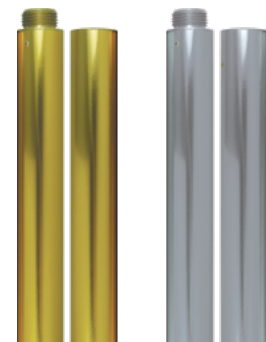

**With Top Cap & Bottom Plug**

Model	Ht.	Dia.	# of Sections	Lbs.	Item #	Gold		Silver		
						1-11	12+	Item #	1-11	12+
MP-2	6'	1"	2	.92	050319	\$87.00	\$82.50	050331	\$81.50	\$75.00
MP-00	7'	1"	1	.89	050322	63.50	60.50	050334	57.00	54.00
MP-5	7'	1"	2	1.1	050323	114.00	91.00	050335	90.00	87.00
MP-1	8'	1"	1	1.1	050326	73.00	69.50	050338	62.50	58.50
MP-8	8'	1"	2	1.2	050327	104.00	99.50	050339	96.50	94.00
MP-9	8'	1-1/8"	1	1.7	050328	85.00	81.50	050340	85.00	81.50

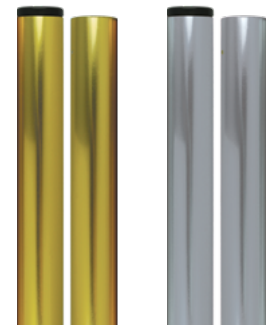

Identical to above poles but supplied with a top cap instead of a top ornament adapter.

**BUDGET WOODEN POLE**

A sleek 5' natural wood banner pole

**POLE INCLUDES:**

- Slip fit wood ball
- Two nylon flag ties

Only available in 1 piece

Model	Item #	Height	Dia.	# of Sections	1-11	12+	Lbs.
BP-5	050288	5'	15/16"	1	\$14.30	\$13.50	1.0



**ADJUSTABLE ALUMINUM POLE**

Pole adjusts to any height between 6' and 10' using a tool-free twist-lock setting. Comes with ornament top adapter\*, cord & tassel ring, flag rings and capped bottom. Available in shiny gold anodized finish only.

\* Compatible ornaments must not include spindle or ferrule.

Model	Item #	Height	Diameter	1-11	12+	Lbs.
AAP-10	050293	6' - 10'	1-1/8"	\$87.00	\$82.00	1.4



**WHITE FIBERGLASS MARCHING BAND POLES**

Each pole is supplied with a 37" rotating, non-furling sleeve to prevent the flag from tangling around the pole. Comes complete with gold plastic slip fit acorn ornament.

Model	Item #	Ht.	Dia	# of Sections	1-11	12+	Lbs.
MPF-11	050342	6'	1"	1	\$67.00	\$63.50	1.7
MPF-12	050343	8'	1"	1	74.00	70.00	2.2



**GUIDON POLE SET - WITH 2-SECTION NATURAL OAK FINISH POLE**

\* Total Height measures from top of ornament to bottom of ferrule.

**With Silver Fittings**

Each set comes complete with silver metal army spear, chrome plated brass screw joint and chrome plated bottom ferrule.

Item #	Pole Ht.	Total Ht*	Dia.	1-11	12+	Lbs.
050531	7'	7'-11"	1-1/4"	\$289.00	\$273.00	3.5
050532	8'	8'-11"	1-1/4"	307.00	289.00	3.6
050533	9'	9'-11"	1-1/4"	324.00	309.00	4.0

**With Gold Fittings**

Each set comes complete with brass plated metal army spear, brass plated screw joint and brass plated bottom ferrule.

Item #	Pole Ht.	Total Ht*	Dia.	1-11	12+	Lbs.
050545	7'	7'-11"	1-1/4"	\$253.00	\$238.00	4.6
050546	8'	8'-11"	1-1/4"	271.00	253.00	5.1
050547	9'	9'-11"	1-1/4"	287.00	273.00	5.4



# INDOOR & PARADE ACCESSORIES

## POLES

### GUIDON POLE STANDS

These easily movable cast stands come complete with our Guidon Pole Bottom Ferrule Adapter as shown below. The pricing below includes the adapter - no need to order the adapter as a separate item. **Not intended for outdoor display.**

Item	Description	Dia.	Ht.	Price	Lbs.
050551	Silver Chrome Plated Finish	12"	4-3/4"	\$472.00	14.3
050552	Silver Painted Finish	12"	4-3/4"	306.00	14.3



Chrome Plated



Painted

### GUIDON POLE BOTTOM FERRULE ADAPTER

This injection molded tapered nylon sleeve can also be used with our 1-1/4" B-100 American Beauty, PMB-M Regent and PMB-P Viscount stands to seat the pointed end of the bottom ferrule securely into the floor stand.

Item #	1-5	6+	Lbs.
050543	\$35.00	\$31.50	.25

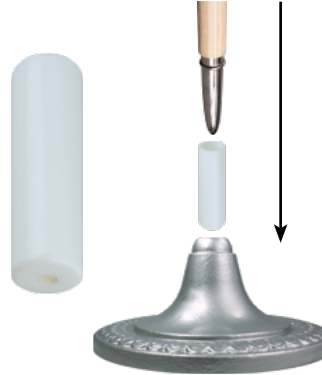

### 1" DIAMETER BUDGET ALUMINUM LEAD PARADE BANNER POLES

- Finish choices include shiny bright-dipped gold anodized or silver mill.
- Poles come with gold plated plastic acorn ornaments on each end.
- Two piece poles are coupled together with a solid brass, precision-machined screw joint.
- Poles come complete with flag rings.
- Pole length was determined by allowing 2" on each side for the acorn ornaments and 6" on each side for hand positions.

When ordering a silver pole, gold ornaments are supplied as standard. Pictured banner not included in the pricing below.

Length	Rec. Banner Width	# of Sections	Lbs.	Gold		Silver	
				Item #	Price	Item #	Price
40"	24"	1	.53	050416	\$39.50	050428	\$35.50
40"	24"	2	.68	050417	58.50	050429	51.00
52"	36"	1	.65	050418	43.50	050430	39.50
52"	36"	2	.80	050419	62.50	050431	59.50
64"	48"	1	.78	050420	49.00	050432	43.50
64"	48"	2	.93	050421	60.50	050433	62.50
76"	60"	1	.90	050422	59.50	050434	47.00
76"	60"	2	1.1	050423	75.00	050435	60.50
88"	72"	1	1.1	050424	60.50	050436	62.50
88"	72"	2	1.2	050425	80.00	050437	67.00
100"	84"	2	1.3	050426	88.00	050438	82.50
112"	96"	2	1.5	050427	105.00	050439	96.50



**1-1/8" DIAMETER DELUXE ALUMINUM LEAD PARADE BANNER POLES**

- Finish choices include shiny bright-dipped gold anodized or shiny bright-dipped silver anodized.
- End choices include capped, or ornament adapter (ornaments not included).
- Two piece poles are coupled together with a solid brass, precision-machined screw joint.
- Poles come complete with flag rings.
- Pole length was determined by allowing 6" on each side for hand positions.



When ordering a silver pole, gold ornaments are supplied as standard. Pictured banner not included in the pricing below.

Length	Rec. Banner Width	# of Sections	With Capped Ends					With Ornament Adapters				
			Gold		Silver		Lbs.	Gold		Silver		Lbs.
			Item #	Price	Item #	Price		Item #	Price	Item #	Price	
36"	24"	1	050368	\$47.00	050380	\$47.00	1.1	050392	\$80.00	050404	\$80.00	1.2
36"	24"	2	050369	60.50	050381	60.50	1.4	050393	98.00	050405	98.00	1.5
48"	36"	1	050370	49.00	050382	49.00	1.3	050394	86.00	050406	86.00	1.4
48"	36"	2	050371	70.00	050383	70.00	1.6	050395	110.50	050407	110.50	1.7
60"	48"	1	050372	56.50	050384	56.50	1.5	050396	99.00	050408	99.00	1.6
60"	48"	2	050373	88.50	050385	88.50	1.8	050397	119.00	050409	119.00	1.9
72"	60"	1	050374	64.50	050386	64.50	1.7	050398	102.50	050410	102.50	1.8
72"	60"	2	050375	94.00	050387	94.00	2.0	050399	123.50	050411	123.50	2.1
84"	72"	1	050376	74.00	050388	74.00	1.9	050400	105.00	050412	105.00	2.0
84"	72"	2	050377	103.50	050389	103.50	2.2	050401	132.00	050413	132.00	2.3
96"	84"	2	050378	113.50	050390	113.50	2.4	050402	141.00	050414	141.00	2.5
108"	96"	2	050379	142.50	050391	142.50	2.6	050403	170.00	050415	170.00	2.7

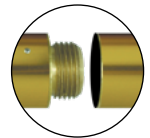

Joint Detail



**15/16" DIAMETER BUDGET WOOD LEAD PARADE BANNER POLES**

- Made of hardwood.
- Poles come complete with slip fit wood ball ornaments on each end.
- Pole length was determined by allowing 2" on each side for the ball ornaments and 6" on each side for hand positions.

Pictured banner not included in the pricing to the right.

Item #	Model	Length	Rec. Banner Width	# of Sections	Price	Lbs.
050440	BP36	40"	24"	1	\$14.90	.84
050441	BP48	52"	36"	1	16.90	1.1

# INDOOR & PARADE ACCESSORIES



## COLLAPSIBLE ALUMINUM PARADE POLE

Pole collapses to 5' 2" with flag still attached, allowing for easy storage. Pole adjusts to any height between 5' 2" and 10' using a tool-free twist-lock setting. Comes with ornament top adapter\*, cord & tassel ring, flag rings and capped bottom. Available in shiny gold anodized finish only. Intended for parade use only; not for use in floor stands.

\* Compatible ornaments must not include spindle or ferrule. Recommended for use with 2'x3', 3'x5' or 4'x6' flags.

Item #	Height	Diameter	1-11	12+	Lbs.
050567	5' 2" - 10'	1-1/8"	\$98.00	\$93.50	1.4



## DOUBLE STRAP LEATHER CARRYING BELTS

Item #	Model	Color	1-11	12+	Lbs.
050449	B-12-W	White	\$128.00	\$123.50	1.0
050450	B-12-BL	Black	116.00	108.00	1.0



## SINGLE STRAP LEATHER CARRYING BELTS

Item #	Model	Color	1-11	12+	Lbs.
050446	B-10-W	White	\$114.50	\$108.00	.70
050447	B-11-BL	Black	96.50	90.00	.70



## DOUBLE STRAP WHITE WEB CARRYING BELT

With woven pole pocket

Item #	Model	1-11	12+	Lbs.
050452	WWD	\$58.50	\$54.50	.50



## SINGLE STRAP WHITE WEB CARRYING BELT

With woven pole pocket

Item #	Model	1-11	12+	Lbs.
050451	WWS	\$46.00	\$44.50	.27

## LEATHERETTE FLAG COVERS

Color may vary

Item #	Model	Length	Width	1-11	12+	Lbs.
050453	C-10	64"	9"	\$39.50	\$35.50	1.2
050454	C-30	76"	9"	46.00	43.50	1.5





CT-3



CT-5



CT-6



CT-5



CT-5

**CORD & TASSELS**

Item #	Model	Color	For Flag Size	Tassel Length	Cord Length	Cord Dia.	1-11	12+	Lbs.
050457	CT-3	Gold	2' x 3'	3-1/2"	108"	1/4"	\$24.00	\$23.00	.07
050458	CT-5	Gold	3' x 5'	4-1/2"	108"	5/8"	31.00	28.00	.15
050459	CT-6	Gold	4' x 6'	6"	108"	5/8"	41.50	38.00	.18
050469	CT-5	Silver	3' x 5'	4-1/2"	108"	5/8"	39.50	36.00	.15
050470	CT-5	White	3' x 5'	4-1/2"	108"	5/8"	39.50	36.00	.15

**BRASS SCREW JOINTS**

For wood poles

Model	Rec. Pole Dia.	Outside Dia.	Inside Dia.	Lbs.	Polished Brass			Chrome Plated		
					Item #	1-11	12+	Item #	1-11	12+
BSJ-1	15/16" & 1"	15/16"	13/16"	.15	050471	\$45.50	\$41.50	050475	\$74.00	\$71.50
BSJ-2	1-1/8"	1-1/8"	31/32"	.40	050472	59.00	55.50	050476	85.50	81.50
BSJ-3	1-1/4"	1-1/4"	1-3/32"	.50	050473	59.00	55.50	050477	95.50	92.00
BSJ-4	1-3/8"	1-3/8"	1-7/32"	.50	—	—	—	050478	126.50	120.00

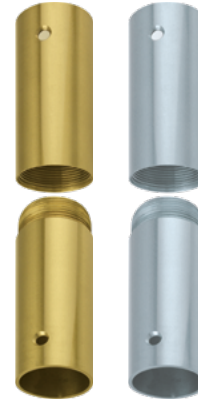

**BRASS SCREW JOINTS**

For aluminum poles

Item #	For Pole Diameter	Outside Joint Diameter	1-11	12+	Lbs.
050479	1"	15/16"	\$26.40	\$26.20	.15
050480	1-1/8"	1"	29.50	27.10	.25



**BRASS ORNAMENT ADAPTERS**

For aluminum poles

Item #	For Pole Diameter	Outside Joint Diameter	1-11	12+	Lbs.
050482	1"	15/16"	\$27.30	\$25.90	.07
050483	1-1/8"	1"	27.30	25.90	.07



**PLASTIC BOTTOM PLUG**

For Regent & Viscount floor stands

Item #	Color	1-11	12+	Lbs.
050499	Black	\$1.28	\$1.16	.02



**BRASS HOOK & EYE**

Additional charge of \$47.00 for installation and balancing. Sold as sets only.

Item #	1-11	12+	Lbs.
050456	\$73.00	\$69.00	.15

# INDOOR & PARADE ACCESSORIES

## STANDARD BRASS FERRULES

For wood poles mounting screws included

Item #	Finish	Outside Dia.	Inside Dia.	1-11	12+	Lbs.
050488	Brass	1"	7/8"	\$16.70	\$15.00	.15
050489	Chrome	1"	7/8"	25.80	23.90	.15



## FLOOR STAND SLEEVE ADAPTERS

Plastic

Item #	Color	Length	Stand Bore Dia.	For Pole Dia.	1-11	12+	Lbs.
050493	White	2"	1-1/4"	1-1/8"	\$2.80	\$2.66	.02
050494	White	2"	1-1/8"	1"	2.80	2.66	.02
050495	White	4-5/8"	1-1/4"	1-1/8"	2.80	2.66	.04
050496	White	4-5/8"	1-1/8"	1"	2.80	2.66	.03
050497	Brown	5-3/16"	1-1/4"	1-1/8"	3.28	2.94	.04
050498	Brown	5-3/16"	1-1/8"	1"	3.28	2.94	.03



## ALUMINUM FLAG RINGS

For aluminum poles

Item #	Color	Rec. Pole Dia.	Outside Ring Dia.	Inside Ring Dia.	1-11	12+	Lbs.
050500	Gold	1"	1-1/8"	1-1/32"	\$5.80	\$5.06	.01
050501	Gold	1-1/8"	1-1/4"	1-5/32"	6.78	6.16	.02
050502	Silver	1"	1-1/8"	1-1/32"	5.80	5.06	.01
050503	Silver	1-1/8"	1-1/4"	1-5/32"	6.78	6.16	.02

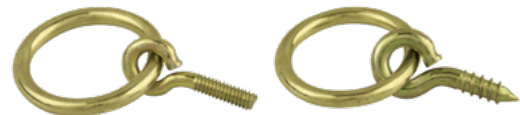

For Aluminum Poles

For Wood Poles

## CORD & TASSEL RINGS

Item #	Pole Material	Outside Ring Diameter	1-11	12+	Lbs.
050484	Wood	15/16"	\$4.22	\$3.50	.02
050485	Aluminum	15/16"	4.22	3.50	.02



For 1" Poles

For 1-1/8" Poles

## BLACK PLASTIC BOTTOM PLUGS

For aluminum poles

Item #	For Pole Diameter	Outside Plug Diameter	1-11	12+	Lbs.
050486	1"	15/16"	\$1.24	\$1.10	.01
050487	1-1/8"	1"	1.24	1.10	.01

## ALUMINUM SPINDLE

Silver only

Item #	1-11	12+	Lbs.
050492	\$10.22	\$9.36	.10



**BLACK STYRENE (PLASTIC) TABLE BASES FOR MOUNTED FLAGS**

Item #	For Flag Size	For # of Flags	Dia.	1-143	144-499	500+	Lbs.
050504	4" x 6"	1	2-1/2"	\$1.28	\$1.12	\$1.04	.025
050505	4" x 6"	2	2-1/2"	1.98	1.62	1.44	.03
050506	4" x 6"	3	2-1/2"	1.98	1.58	1.44	.03
050507	4" x 6"	4	2-1/2"	2.52	2.12	1.98	.03
050508	4" x 6"	5	2-1/2"	2.52	2.12	1.98	.03
050509	4" x 6"	6	2-1/2"	3.00	2.70	2.54	.03
050510	4" x 6"	7	2-1/2"	3.00	2.70	2.54	.03



Style # 1

**STYRENE (PLASTIC) TABLE BASES FOR MOUNTED FLAGS**

Item #	For Flag Size	For # of Flags	Dia.	Color	1-143	144-499	500+	Lbs.
050511	4" x 6"	1	2-11/16"	Gold	\$3.52	\$3.10	\$2.72	.05
050539	4" x 6"	1	2-11/16"	Black	1.54	1.26	1.20	.05



Style # 2

**BLACK WOOD TABLE BASES FOR MOUNTED FLAGS**

Item #	For Flag Size	For # of Flags	Dia.	1-143	144+	Lbs.
050513	12" x 18"	1	4"	\$17.00	\$13.80	.25
050514	12" x 18"	2	5-7/8"	31.00	28.50	.70



Style # 3

**BLACK WOOD TABLE BASE FOR MOUNTED FLAGS**

Item #	For Flag Size	For # of Flags	Dia.	1-143	144+	Lbs.
050517	8" x 12"	2	2-1/2"	\$10.90	\$9.90	.11



Style # 5

**WALNUT WOOD TABLE BASE**

Flag pictured to the right is not included in the pricing below.

Item #	For Flag Size	For # of Flags	Width	Depth	1-143	144+	Lbs.
050528	4" x 6"	1	3"	2"	\$8.30	\$7.30	.08



# HISTORICAL FLAGS OF THE U.S.

## EVOLUTION OF OLD GLORY

Shown here are the 27 legal flags flown throughout our history, with effective date(s) and state addition(s) that changed the star field.

By law, a star is added to the U.S. Flag on the 4th of July following the admission of a State(s) to the Union.

Contrary to popular belief, the first official U.S. Flag was not the Betsy Ross Flag (13 stars in a circle) but the staggered star pattern shown in the 13-star flag below.

It is important to note that no U.S. Flag ever becomes obsolete. Each flag shown is still a legal flag and may be flown at any time.

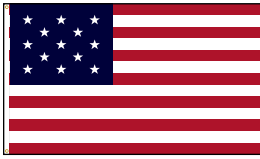

**13 STARS - 1777-1795**  
(CT, DE, GA, MD, MA, NH, NJ, NY, NC, PA, RI, SC, VA)



**15 STARS - 1795-1818**  
(KY, VT)



**20 STARS - 1818-1819**  
(IN, LA, MS, OH, TN)



**21 STARS - 1819-1820**  
(IL)



**23 STARS - 1820-1822**  
(AL, ME)

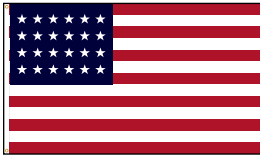

**24 STARS - 1822-1836**  
(MO)

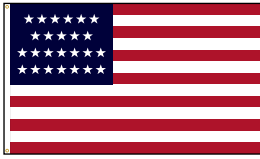

**25 STARS - 1836-1837**  
(AR)



**26 STARS - 1837-1845**  
(MI)



**27 STARS - 1845-1846**  
(FL)

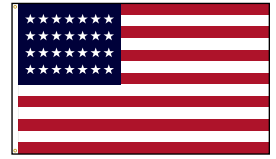

**28 STARS - 1846-1847**  
(TX)



**29 STARS - 1847-1848**  
(IA)



**30 STARS - 1848-1851**  
(WI)



**31 STARS - 1851-1858**  
(CA)



**32 STARS - 1858-1859**  
(MN)



**33 STARS - 1859-1861**  
(OR)

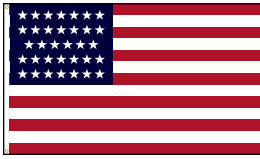

**34 STARS - 1861-1863**  
(KS)

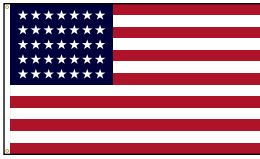

**35 STARS - 1863-1865**  
(WV)

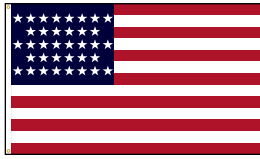

**36 STARS - 1865-1867**  
(NV)



**37 STARS - 1867-1877**  
(NE)

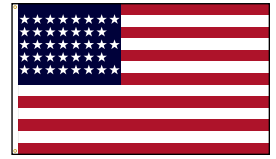

**38 STARS - 1877-1890**  
(CO)

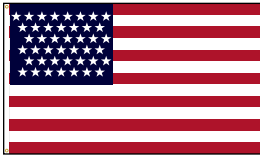

**43 STARS - 1890-1891**  
(ID, MT, ND, SD, WA)

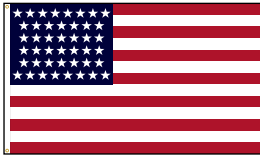

**44 STARS - 1891-1896**  
(WY)

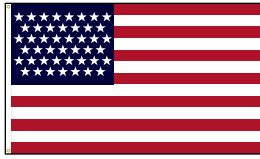

**45 STARS - 1896-1908**  
(UT)

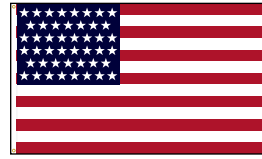

**46 STARS - 1908-1912**  
(OK)

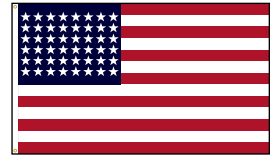

**48 STARS - 1912-1959**  
(AZ, NM)



**49 STARS - 1959-1960**  
(AK)



**50 STARS - 1960-present**  
(HI)

## EVOLUTION OF OLD GLORY

4' x 6' and 5' x 8' flags are made to order. Please allow up to two weeks for shipment.

# of Stars	3' X 5' Nylon Outdoor Applied Field Sewn Stripes (Weight .65 Lbs)		4' X 6** Nylon Outdoor Applied Field Sewn Stripes (Weight 1.0 Lbs)		5' X 8** Nylon Outdoor Applied Field Sewn Stripes (Weight 1.4 Lbs)	
	Item #	Price	Item #	Price	Item #	Price
13	060026	\$92.50	060104	\$102.00	060182	\$136.00
15	060027	98.00	060105	106.50	060183	143.00
20	060028	104.50	060106	112.00	060184	150.00
21	060029	110.50	060107	119.50	060185	162.00
23	060030	115.50	060108	123.00	060186	166.00
24	060031	118.50	060109	127.50	060187	168.00
25	060032	119.50	060110	129.50	060188	171.00
26	060033	122.00	060111	133.00	060189	174.00
27	060034	123.00	060112	134.50	060190	176.00
28	060035	127.50	060113	136.50	060191	180.00
29	060036	130.50	060114	138.00	060192	181.00
30	060037	133.00	060115	140.50	060193	185.00
31	060038	135.50	060116	142.50	060194	190.00
32	060039	136.50	060117	145.00	060195	191.00
33	060040	139.50	060118	148.00	060196	193.00
34	060041	140.50	060119	149.50	060197	197.00
35	060042	144.00	060120	153.50	060198	201.00
36	060043	145.00	060121	154.50	060199	205.00
37	060044	148.00	060122	157.00	060200	208.00
38	060045	149.50	060123	159.50	060201	210.00
43	060046	154.50	060124	171.50	060202	222.00
44	060047	157.00	060125	175.00	060203	227.00
45	060048	159.50	060126	176.00	060204	229.00
46	060049	161.00	060127	178.00	060205	232.00
48	060050	166.50	060128	183.00	060206	237.00
49	060051	169.50	060129	185.00	060207	239.00
50	See <a href="#">pages 10-24</a>					



## BENNINGTON FLAGS

Fully Sewn with Embroidered Star Field

Item #	Size	Material	1-5	6+	Lbs.
060714	3' X 5'	O/D Nylon	\$59.50	\$56.00	.60

Item #	Size	Mounted	◆1-11 Doz	◆12+ Doz	Lbs.
060695	4" X 6"	E-Gloss	\$31.20	\$28.08	.36

◆ Sold By The Dozen

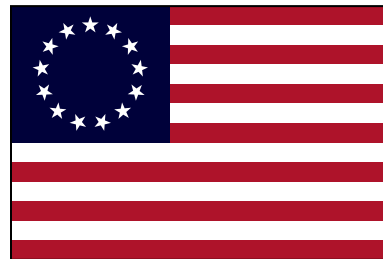

## BETSY ROSS FLAGS

Fully Printed

Item #	Size	Material	1-5	6+	Lbs.
060666	2' x 3'	O/D Nylon	\$36.20	\$35.00	.25
060667	3' x 5'	O/D Nylon	63.00	59.50	.45

Fully Sewn with Embroidered Star Fields

Item #	Size	Material	1-5	6+	Lbs.
060700	2' x 3'	O/D Nylon	\$55.00	\$53.00	.35
060701	3' x 5'	O/D Nylon	51.50	50.50	.60

Fully Sewn with Appliqued Star Fields

Item #	Size	Material	1-5	6+	Lbs.
060702	4' x 6'	O/D Nylon	\$73.00	\$66.00	.85
060703	5' x 8'	O/D Nylon	121.00	114.00	1.4

## GADSDEN FLAGS

The Gadsden flag and other rattlesnake flags were widely used during the American Revolution. There was no standard American flag at the time. The Gadsden flag was first used in February 1776. The flag depicts a rattlesnake in the attitude of going to strike with the words 'DONT TREAD ON ME' underneath.

Item #	Size	Material	1-5	6+	Lbs.
060566	3' x 5'	O/D Nylon	\$65.00	\$58.50	.45
060742	4' x 6'	O/D Nylon	95.50	—	.70
060743	5' x 8'	O/D Nylon	132.00	—	1.0
060744	6' x 10'	O/D Nylon	234.00	—	1.8

# HISTORICAL FLAGS OF THE U.S.

3' X 5' OUTDOOR NYLON



**ALAMO**

Item #	1-5	6+	Lbs.
060545	\$65.00	\$58.50	.45

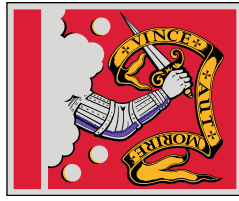

**BEDFORD**

Item #	1-5	6+	Lbs.
060546	\$74.50	\$67.50	.45



**BRITISH RED ENSIGN**

Item #	1-5	6+	Lbs.
060547	\$64.00	\$56.50	.45



**BRITISH UNION**

Item #	1-5	6+	Lbs.
060548	\$64.00	\$56.50	.45

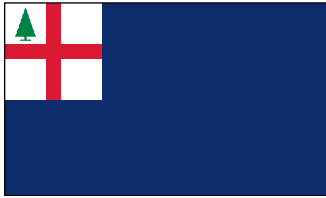

**BUNKER HILL**

Item #	1-5	6+	Lbs.
060549	\$65.00	\$58.50	.45



**CALIFORNIA REPUBLIC**

Item #	1-5	6+	Lbs.
060550	\$65.00	\$58.50	.45

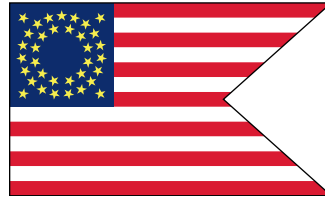

**CAVALRY GUIDON**

Item #	1-5	6+	Lbs.
060741	\$64.00	\$56.50	.45

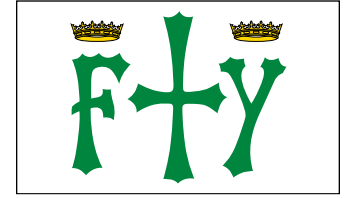

**COLUMBUS**

Item #	1-5	6+	Lbs.
060552	\$65.00	\$58.50	.45

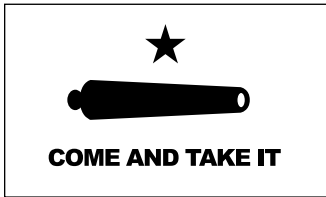

**COME & TAKE IT**

Item #	1-5	6+	Lbs.
060553	\$65.00	\$58.50	.45



**COMMODORE PERRY**

Item #	1-5	6+	Lbs.
060554	\$65.00	\$58.50	.45



**CONTINENTAL**

Item #	1-5	6+	Lbs.
060555	\$64.00	\$56.50	.45



**COWPENS**

Item #	1-5	6+	Lbs.
060556	\$64.00	\$56.50	.45

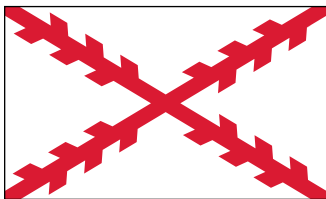

**CROSS OF BURGUNDY**

Item #	1-5	6+	Lbs.
060557	\$64.00	\$56.50	.45

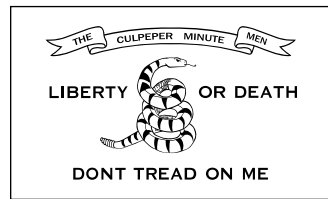

**CULPEPER**

Item #	1-5	6+	Lbs.
060559	\$65.00	\$58.50	.45



**1st NAVY JACK**

Item #	1-5	6+	Lbs.
060561	\$65.00	\$58.50	.45



**FLEUR-DE-LIS (BLUE-3)**

Item #	1-5	6+	Lbs.
060562	\$64.00	\$56.50	.45

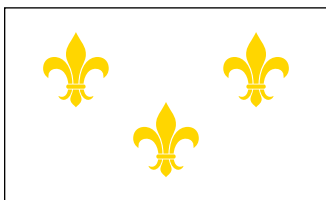

**FLEUR-DE-LIS (WHITE-3)**

Item #	1-5	6+	Lbs.
060563	\$65.00	\$58.50	.45

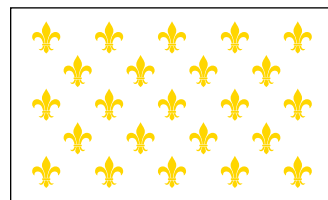

**FLEUR-DE-LIS (WHITE-23)**

Item #	1-5	6+	Lbs.
060564	\$65.00	\$58.50	.45



**FORT MOULTRIE**

Item #	1-5	6+	Lbs.
060565	\$65.00	\$58.50	.45

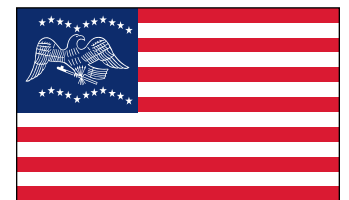

**GENERAL FREMONT**

Item #	1-5	6+	Lbs.
060567	\$64.00	\$56.50	.45

# HISTORICAL FLAGS OF THE U.S.

3' X 5' OUTDOOR NYLON

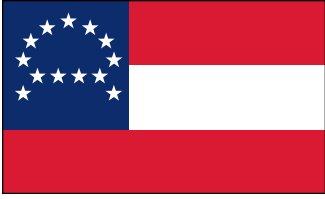

**GENERAL LEE'S HEADQUARTERS**

Item #	1-5	6+	Lbs.
060739	\$64.00	\$56.50	.45

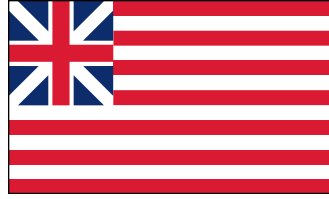

**GRAND UNION**

Item #	1-5	6+	Lbs.
060568	\$64.00	\$56.50	.45

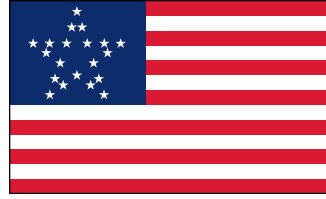

**GREAT STAR**

Item #	1-5	6+	Lbs.
060569	\$64.00	\$56.50	.45



**GREEN MOUNTAIN BOYS**

Item #	1-5	6+	Lbs.
060570	\$64.00	\$56.50	.45

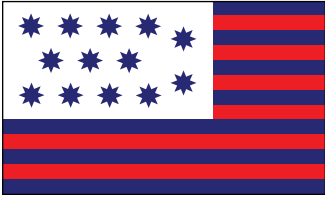

**GUILFORD COURTHOUSE**

Item #	1-5	6+	Lbs.
060571	\$64.00	\$56.50	.45



**LORD BALTIMORE**

Item #	1-5	6+	Lbs.
060572	\$64.00	\$56.50	.45

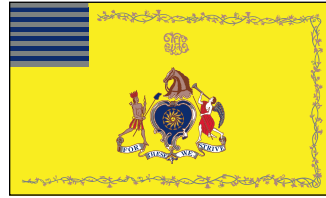

**PHILADELPHIA LIGHT HORSE TROOP**

Item #	1-5	6+	Lbs.
060573	\$74.50	\$67.50	.45

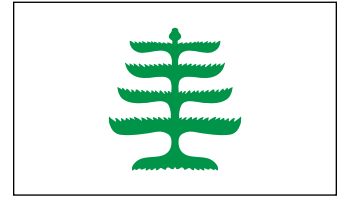

**PINE TREE**

Item #	1-5	6+	Lbs.
060574	\$65.00	\$58.50	.45

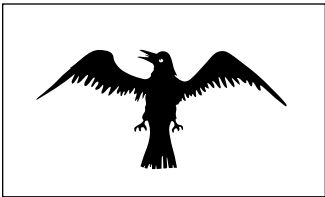

**RAVEN**

Item #	1-5	6+	Lbs.
060575	\$65.00	\$58.50	.45



**RHODE ISLAND REGIMENT**

Item #	1-5	6+	Lbs.
060576	\$64.00	\$56.50	.45

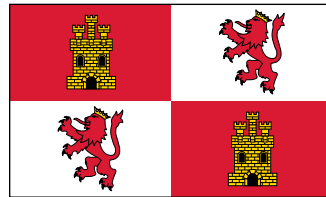

**ROYAL STANDARD OF SPAIN**

Item #	1-5	6+	Lbs.
060577	\$65.00	\$58.50	.45



**RUSSIAN AMERICAN COMPANY**

Item #	1-5	6+	Lbs.
060578	\$74.50	\$67.50	.45



**SERAPIS**

Item #	1-5	6+	Lbs.
060579	\$64.00	\$56.50	.45

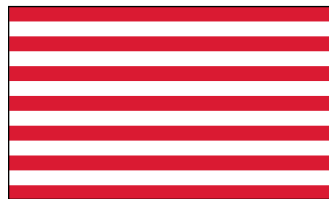

**SONS OF LIBERTY**

Item #	1-5	6+	Lbs.
060580	\$65.00	\$58.50	.45



**TAUNTON**

Item #	1-5	6+	Lbs.
060581	\$64.00	\$56.50	.45

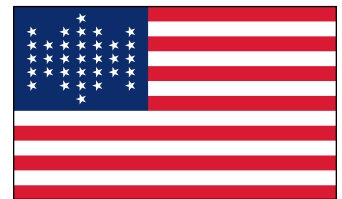

**UNION CIVIL WAR**

Item #	1-5	6+	Lbs.
060582	\$64.00	\$56.50	.45



**WASHINGTON'S COMMANDER-IN-CHIEF**

Item #	1-5	6+	Lbs.
060740	\$65.00	\$58.50	.45



**WASHINGTON'S CRUISERS**

Item #	1-5	6+	Lbs.
060584	\$65.00	\$58.50	.45



See [pages 20-22](#) for mounting sets only and [pages 57-59](#) for ornament options. Flags shown with oak poles, ABS spear and Endura stand.

**ARMED FORCES INDOOR/PARADE FLAGS**

**Flags With Pole Hem Only**

Item #	Size	Material	Flag	1-5	6+	Lbs.
070058	3' x 5'	Nylon	Army	\$72.20	\$67.40	.40
070060	3' x 5'	Nylon	Marine Corps	72.10	67.20	.40
070061	3' x 5'	Nylon	Navy	72.10	67.20	.40
070057	3' x 5'	Nylon	Air Force	72.10	67.20	.40
070059	3' x 5'	Nylon	Coast Guard	72.10	67.20	.40
070492	3' x 5'	Nylon	Space Force	72.20	67.40	.40
070156	3' x 5'	Nylon	POW-MIA	72.10	67.20	.40

**Flags With Pole Hem And Fringe**

\* Silver fringe will be used for POW-MIA and Space Force flags unless gold is specified.

Item #	Size	Material	Flag	1-5	6+	Lbs.
070063	3' x 5'	Nylon	Army	\$93.80	\$89.00	.60
070065	3' x 5'	Nylon	Marine Corps	93.60	88.70	.60
070066	3' x 5'	Nylon	Navy	93.60	88.70	.60
070062	3' x 5'	Nylon	Air Force	93.60	88.70	.60
070064	3' x 5'	Nylon	Coast Guard	93.60	88.70	.60
070488	3' x 5'	Nylon	Space Force*	93.80	89.00	.60
070151	3' x 5'	Nylon	POW-MIA*	93.60	88.70	.60



3' x 5' Nylon

**OUTDOOR AIR FORCE FLAGS**

Officially Licensed Manufacturer for the United States Air Force

Item #	Size	Material	1-5	6+	Lbs.
070005	12" x 18"	Nylon	\$21.30	\$19.20	.10
070022	2' x 3'	Nylon	54.50	52.90	.25
070052	3' x 5'	Nylon	50.60	45.70	.45
070067	4' x 6'	Nylon	116.50	105.50	.70
070082	5' x 8'	Nylon	149.00	147.00	1.0
070375	6' x 10'	Nylon	291.00	—	1.8
070409	3' x 5'	Poly Max	107.00	94.00	.65
070010	2' x 3'	E-Poly	19.80	16.80	.15



3' x 5' Nylon

**OUTDOOR ARMY FLAGS**

Officially Licensed Manufacturer for the United States Army

Item #	Size	Material	1-5	6+	Lbs.
070006	12" x 18"	Nylon	\$21.30	\$19.20	.10
070023	2' x 3'	Nylon	37.30	35.80	.25
070053	3' x 5'	Nylon	50.60	45.70	.45
070068	4' x 6'	Nylon	92.00	84.00	.70
070083	5' x 8'	Nylon	127.00	117.00	1.0
070376	6' x 10'	Nylon	291.00	—	1.8
070406	3' x 5'	Poly Max	107.00	94.00	.65
070011	2' x 3'	E-Poly	19.80	16.80	.15



**OUTDOOR AIR FORCE LOGO FLAG**

Officially Licensed Manufacturer for the United States Air Force

Item #	Size	Material	1-5	6+	Lbs.
070483	3' x 5'	Nylon	\$50.60	\$45.70	.45



**OUTDOOR ARMY LOGO FLAG**

Officially Licensed Manufacturer for the United States Army

Item #	Size	Material	1-5	6+	Lbs.
070498	3' x 5'	Nylon	\$50.60	\$45.70	0.45

**OUTDOOR MARINE CORPS FLAGS**

Officially Licensed Manufacturer for the United States Marine Corps

Item #	Size	Material	1-5	6+	Lbs.
070008	12" x 18"	Nylon	\$21.30	\$19.20	.10
070025	2' x 3'	Nylon	48.90	47.20	.25
070055	3' x 5'	Nylon	50.60	45.70	.45
070070	4' x 6'	Nylon	107.00	96.00	.70
070085	5' x 8'	Nylon	143.00	136.00	1.0
070378	6' x 10'	Nylon	291.00	—	1.8
070408	3' x 5'	Poly Max	107.00	94.00	.65

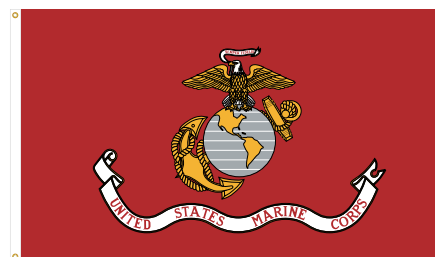

3' x 5' Nylon

# MILITARY AND CIVILIAN SERVICE

MILITARY



3' x 5' Nylon

## OUTDOOR NAVY FLAGS

Officially Licensed Manufacturer for the United States Navy

Item #	Size	Material	1-5	6+	Lbs.
070009	12" x 18"	Nylon	\$21.30	\$19.20	.10
070026	2' x 3'	Nylon	63.30	61.50	.25
070056	3' x 5'	Nylon	50.60	45.70	.45
070071	4' x 6'	Nylon	124.50	118.50	.70
070086	5' x 8'	Nylon	176.00	168.00	1.0
070379	6' x 10'	Nylon	291.00	—	1.8
070407	3' x 5'	Poly Max	107.00	94.00	.65
070013	2' x 3'	E-Poly	19.80	16.80	.15



3' x 5' Nylon

## OUTDOOR COAST GUARD FLAGS

Item #	Size	Material	1-5	6+	Lbs.
070007	12" x 18"	Nylon	\$21.30	\$19.20	.10
070024	2' x 3'	Nylon	37.30	35.80	.25
070054	3' x 5'	Nylon	50.60	45.70	.45
070069	4' x 6'	Nylon	92.00	84.00	.70
070084	5' x 8'	Nylon	127.00	117.00	1.0
070377	6' x 10'	Nylon	291.00	—	1.8
070410	3' x 5'	Poly Max	107.00	94.00	.65

## OUTDOOR SPACE FORCE LOGO FLAGS

Officially Licensed Manufacturer for the United States Space Force

Item #	Size	Color	Material	1-5	6+	Lbs.
070484	3' x 5'	White	Nylon	\$50.60	\$45.70	.45
070485	3' x 5'	Black	Nylon	50.60	45.70	.45
070490	4' x 6'	White	Nylon	116.50	105.50	.70
070491	4' x 6'	Black	Nylon	116.50	105.50	.70

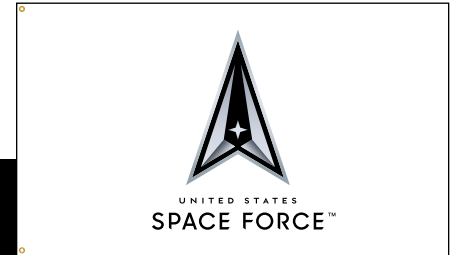

## MOUNTED ARMY FLAGS

Item #	Size	Material	Staff Size	Staff Material	Staff Color	1-143	144+	Lbs.
070108	4" x 6"	Plastic	3/16" x 10"	Plastic	Gold	\$0.58	\$0.50	.02



## MOUNTED COAST GUARD FLAGS

Item #	Size	Material	Staff Size	Staff Material	Staff Color	1-143	144+	Lbs.
070109	4" x 6"	Plastic	3/16" x 10"	Plastic	Gold	\$0.58	\$0.50	.02



## MOUNTED NAVY FLAGS

Item #	Size	Material	Staff Size	Staff Material	Staff Color	1-143	144+	Lbs.
070111	4" x 6"	Plastic	3/16" x 10"	Plastic	Gold	\$0.58	\$0.50	.02



**OUTDOOR POW-MIA FLAGS (SINGLE FACE)**

With canvas header & brass grommets

See [page 4](#) for pricing add-ons for pole hem & fringe flags and pole hem only flags. Silver fringe will be used for POW-MIA flags unless gold is specified.

Item #	Size	Material	1-5	6+	Lbs.
070136	12" x 18"	Nylon	\$21.30	\$19.20	.10
070138	2' x 3'	Nylon	32.80	29.90	.25
070140	3' x 5'	Nylon	50.60	45.70	.45
070141	4' x 6'	Nylon	91.50	83.00	.70
070142	5' x 8'	Nylon	127.00	114.00	1.0
070143	6' x 10'	Nylon	180.00	164.00	1.7
070423	8' x 12'	Nylon	314.00	271.00	3.2
070399	3' x 5'	Poly Max	60.50	54.50	.65
070400	4' x 6'	Poly Max	95.00	90.00	.95
070401	5' x 8'	Poly Max	173.00	169.00	1.5
070137	2' x 3'	E-Poly	19.80	16.80	.15



3' x 5' Nylon



Front Side



Back Side



Front Side



Back Side

**OUTDOOR POW-MIA FLAGS (DOUBLE FACE)**

With canvas header & brass grommets

See [page 4](#) for pricing add-ons for pole hem & fringe flags and pole hem only flags. Silver fringe will be used for POW-MIA flags unless gold is specified.

Item #	Size	Material	1-5	6+	Lbs.
070144	12" x 18"	Nylon	\$42.60	\$38.50	.17
070145	2' x 3'	Nylon	46.80	42.30	.35
070146	3' x 5'	Nylon	80.00	75.00	.60
070147	4' x 6'	Nylon	98.00	94.50	1.0
070148	5' x 8'	Nylon	168.00	162.00	1.5
070149	6' x 10'	Nylon	215.00	207.00	2.2
070424	8' x 12'	Nylon	404.00	375.00	3.9
070403	3' x 5'	Poly Max	105.50	103.50	1.2
070404	4' x 6'	Poly Max	125.50	120.50	1.8
070405	5' x 8'	Poly Max	241.00	239.00	2.5

**MOUNTED POW-MIA FLAGS**

With gold spears

Item #	Size	Flag Material	Staff Size, Color & Material	1-143	144+	Lbs.
070171	4" x 6"	Lightweight Cotton	3/16" x 10" Natural Wood	\$1.52	\$1.22	.02
070172	4" x 6"	No-Fray Cotton	3/16" x 10" Natural Wood	1.22	0.86	.02
070416	8" x 12"	E-Gloss	1/4" x 18" Black Wood	10.60	7.60	.05



4" x 6"  
Lightweight  
Cotton

**POW-MIA AUTO WINDOW FLAG**

Comes complete with 11" x 13" polyester flag. Supplied with 1-piece plastic bracket.

Item #	1-11	12+	Lbs.
070384	\$25.90	\$23.40	.28



# MILITARY AND CIVILIAN SERVICE

MILITARY



**AIRBORNE**



**BLUE ANGELS**



**82nd AIRBORNE**

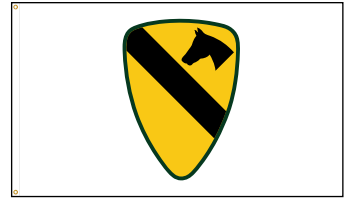

**1st CAVALRY DIVISION**



**101st AIRBORNE**

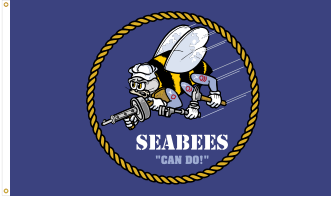

**SEABEES**

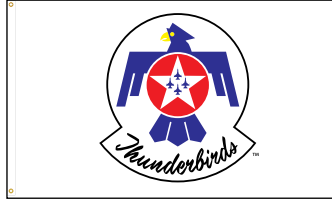

**THUNDERBIRDS**



**VIETNAM INSIGNIA**

## MISCELLANEOUS MILITARY FLAGS

With canvas header & brass grommets

Officially Licensed Manufacturer

Item #	Size	Material	Description	1-11	12+	Lbs.
070253	3' x 5'	Nylon	Airborne	\$50.60	\$45.70	.45
070254	3' x 5'	Nylon	Blue Angels	50.60	45.70	.45
070256	3' x 5'	Nylon	82nd Airborne	50.60	45.70	.45
070257	3' x 5'	Nylon	1st Cavalry Division	50.60	45.70	.45
070258	3' x 5'	Nylon	101st Airborne	50.60	45.70	.45
070259	3' x 5'	Nylon	Seabees	50.60	45.70	.45
070260	3' x 5'	Nylon	Thunderbirds	50.60	45.70	.45
070262	3' x 5'	Nylon	Vietnam Insignia	50.60	45.70	.45



**AIR FORCE RETIRED**



**ARMY RETIRED**



**COAST GUARD RETIRED**



**MARINE CORPS RETIRED**



**NAVY RETIRED**

## ARMED FORCES RETIREMENT FLAGS

With canvas header & brass grommets

Officially Licensed Manufacturer



Item #	Size	Material	Description	1-5	6+	Lbs.
070188	3' x 5'	Nylon	Air Force Retired	\$50.60	\$45.70	.45
070499	3' x 5'	Nylon	Army Retired	50.60	45.70	.45
070190	3' x 5'	Nylon	Coast Guard Retired	50.60	45.70	.45
070191	3' x 5'	Nylon	Marine Corps Retired	50.60	45.70	.45
070193	3' x 5'	Nylon	Navy Retired	50.60	45.70	.45

**MILITARY ANNIVERSARY FLAGS**

Nylon with canvas header & brass grommets

Officially Licensed Manufacturer



**Army 250th Anniversary**

Item #	Size	1-5	6+	Lbs.
070503	2' x 3'	\$37.30	\$35.80	.25
070500	3' x 5'	50.60	45.70	.45



**Marine 250th Anniversary**

Item #	Size	1-5	6+	Lbs.
070504	2' x 3'	\$37.30	\$35.80	.25
070501	3' x 5'	50.60	45.70	.45



**Navy 250th Anniversary**

Item #	Size	1-5	6+	Lbs.
070505	2' x 3'	\$37.30	\$35.80	.25
070502	3' x 5'	50.60	45.70	.45



Item #	Size	Material	Price	Lbs.
070475	3' x 5'	Nylon	\$73.00	.45

**OUTDOOR HONOR & REMEMBER FLAG**

Honor and Remember flags show support for all the American lives lost in the defense of Freedom.

- **The Red Field** represents the blood spilled by brave men and women in America's military throughout our history, who willingly gave their lives so that we all would remain free.
- **The Blue Star** represents active service in military conflict. This symbol originated with World War I, but on this flag it signifies service through all generations from the American Revolution to present day.
- **The White Border** beneath and surrounding the gold star recognizes the purity of sacrifice. There is no greater price an American can pay than to give his or her life in service to our country.
- **The Gold Star** signifies the ultimate sacrifice of a warrior in active service who will not return home. Gold reflects the value of the life that was given.
- **The Folded Flag** signifies the final tribute to an individual life that a family sacrificed and gave to the nation.
- **The Flame** is an eternal reminder of the spirit that has departed this life yet burns on in the memory of all who knew and loved the fallen hero.

**OUTDOOR VETERANS COMMEMORATIVE FLAGS**

With canvas header & brass grommets

Item #	Size	Material	Description	1-5	6+	Lbs.
070239	3' x 5'	Nylon	Korean War	\$119.50	\$117.00	.45
070240	3' x 5'	Nylon	Vietnam	129.00	126.50	.45



3' x 5' Nylon



4" x 6" E-Gloss

**MERCHANT MARINE FLAGS**

- Outdoor flags supplied with canvas header & brass grommets.
- 4" x 6" mounted on 3/16" x 10" black plastic staff with gold spear.

♦ Sold By The Dozen

Item #	Size	Material	1-5	6+	Lbs.
070385	12" x 18"	Nylon O/D	\$21.30	\$19.20	.10
070386	2' x 3'	Nylon O/D	54.50	52.90	.25
070387	3' x 5'	Nylon O/D	81.00	75.00	.45
070388	4' x 6'	Nylon O/D	116.50	105.50	.70
070389	5' x 8'	Nylon O/D	149.00	147.00	1.0
070192	3' x 5'	E-Poly O/D	24.00	22.00	.32
Item #	Size	Material	♦1-11 Doz	♦12+ Doz	Lbs.
070380	4" x 6"	E-Gloss Mtd	\$31.20	\$28.08	.36



Korean War



Vietnam

# MILITARY AND CIVILIAN SERVICE

CIVILIAN



**EMS**

Size	Material	Item #	1-5	6+	Lbs.
3' x 5'	Nylon O/D	070287	\$64.00	\$56.50	.45



**FIRE DEPARTMENT**

Item #	1-5	6+	Lbs.
070283	\$64.00	\$56.50	.45



**FIRE RESCUE**

Item #	1-5	6+	Lbs.
070286	\$64.00	\$56.50	.45



**FIREFIIGHTERS**

Size	Material	Item #	1-5	6+	Lbs.
3' x 5'	Nylon O/D	070284	\$64.00	\$56.50	.45



**FIREMAN MOURNING**

Item #	1-5	6+	Lbs.
070312	\$64.00	\$56.50	.45



**FIREMAN REMEMBRANCE**

Item #	1-5	6+	Lbs.
070322	\$65.00	\$58.50	.45



**FIREMEN**

Size	Material	Item #	1-5	6+	Lbs.
3' x 5'	Nylon O/D	070285	\$64.00	\$56.50	.45



**POLICE MOURNING**

Item #	1-5	6+	Lbs.
070313	\$64.00	\$56.50	.45



**POLICE REMEMBRANCE**

Item #	1-5	6+	Lbs.
070323	\$65.00	\$58.50	.45



**STAR OF LIFE**

Size	Material	Item #	1-5	6+	Lbs.
2' x 3'	Nylon O/D	-	-	-	-
3' x 5'	Nylon O/D	070288	\$64.00	\$56.50	.45



**THIN BLUE LINE**

Item #	1-5	6+	Lbs.
070478	\$26.60	\$25.30	.25
070474	33.50	32.00	.45



**THIN RED LINE**

Item #	1-5	6+	Lbs.
070479	\$26.60	\$25.30	.25
070477	33.50	32.00	.45

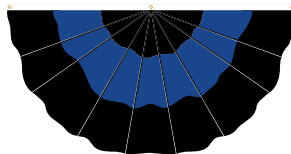

**NYLON THIN BLUE LINE FAN**

Size	Material	Item #	1-11	12-23	24+	Lbs.
3' x 6'	Nylon O/D	070480	\$70.30	\$63.60	\$60.60	.90

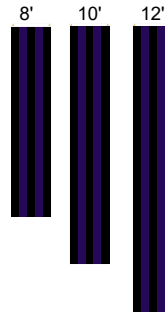

**NYLON MOURNING PULLDOWNS**

Item #	Size	Price	Lbs.
070319	8' x 20"	\$34.50	.50
070320	10' x 20"	38.50	.60
070321	12' x 20"	41.50	.65

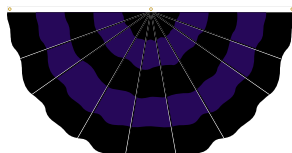

**NYLON MOURNING FAN**

Size	Material	Item #	Price	Lbs.
3' x 6'	Nylon O/D	070318	\$62.50	.90

**BLACK NYLON MOURNING STREAMERS**

Item #	Size	Style	Price	Lbs.
070481	2" x 5'	Single	\$16.80	.02
070482	2" x 5'	Double	20.50	.03



## THERMOPLASTIC MEMORIAL MARKERS

Permanently antiqued and highlighted in bronze with a clear protective over coating. Supplied complete with a 3/8" x 18" silver aluminum rod for easy ground planting. Rear flag holder will accept up to a 3/8" diameter staff.

Item #	Description	1-5	6+	Lbs.
070362	U.S. Veteran	\$27.20	\$24.60	.40
070352	U.S. War Veteran	27.20	24.60	.45
070353	Revolutionary Minuteman	27.20	24.60	.45
070354	Grand Army of The Republic	27.20	24.60	.45
070355	Confederate Veteran	27.20	24.60	.45
070356	World War I	27.20	24.60	.45
070357	World War II	27.20	24.60	.45
070358	Korean Yalu River	27.20	24.60	.45
070359	Korean Eagle	27.20	24.60	.45
070360	Vietnam Bamboo	27.20	24.60	.45
070361	Vietnam Star	27.20	24.60	.45



U.S. Veteran  
Shown With Planting Rod



U.S. Veteran



U.S. War Veteran



Revolutionary  
Minuteman



Grand Army of the  
Republic



Confederate  
Veteran



World War I



World War II



Korean Yalu River



Korean Eagle



Vietnam Bamboo



Vietnam Star

MEMORIAL CASES



Back Closure

CHERRY

Beveled glass front with Great Seal of the USA

070331 shown

Item #	Style	Rec. Flag Size	1-5	6+	Lbs.
070331	with Etched Seal	5' x 9-1/2'	\$524.00	\$500.00	7.9
070332	without Etched Seal	5' x 9-1/2'	506.00	482.00	7.9



Back Closure

OAK

Glass front

070334 shown

Model	Item #	Rec. Flag Size	1-5	6+	Lbs.
IFC-2	070333	3' x 5'	\$254.00	\$243.00	3.3
IFC-1	070334	5' x 9-1/2'	324.50	308.50	5.8



Back Closure

METALLIC GRAY

Glass front

Model	Item #	Rec. Flag Size	1-5	6+	Lbs.
IFC-G	070476	5' x 9-1/2'	\$324.50	\$308.50	5.8



Back Closure

POPLAR

Cherry finish

Glass front

Model	Item #	Rec. Flag Size	1-5	6+	Lbs.
IFC-P	070335	5' x 9-1/2'	\$161.00	\$154.50	5.3



Back Closure

MAPLE

Plexiglass front

Model	Item #	Rec. Flag Size	1-5	6+	Lbs.
IFC-M	070336	5' x 9-1/2'	\$161.00	\$154.50	5.2



Zipper Closure

PLASTIC

With zipper

Model	Item #	Rec. Flag Size	1-5	6+	Lbs.
MFC-1	070339	5' x 9-1/2'	\$32.90	\$29.00	.17

Flags pictured in the Memorial Cases below are not included in the pricing. See pages 10-11 and pages 16-17 for U.S. Flags.

## INTERNATIONAL CODE OF SIGNALS

Nylon, sewn throughout with double-stitched seams in approved colors. Set is supplied with durable storage/carrying bag.

**Canvas Header with Brass Grommets - Size: 3**

- **26 Alphabet Flags:** 2' x 2'
- **11 Pennants:** 1-1/3' x 3'
- **3 Substitutes:** 1-1/3' x 2-1/3'

### Set

Item #	Size	Price	Lbs.
080843	3	\$1,240.00	11

### Individual Flags

Size	Price	Lbs.
3	\$51.50	.24



**A-Alfa**  
Diver Down  
Keep Clear

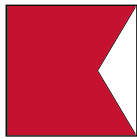

**B-Bravo**  
Dangerous  
Cargo



**C-Charlie**  
Yes



**D-Delta**  
Keep Clear



**E-Echo**  
Altering Course  
to Starboard

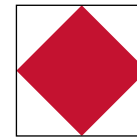

**F-Foxtrot**  
Disabled



**G-Golf**  
Want a Pilot

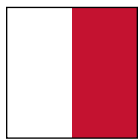

**H-Hotel**  
Pilot on  
Board

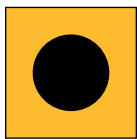

**I-India**  
Altering  
Course to Port



**J-Juliet**  
On Fire Keep  
Clear



**K-Kilo**  
Desire to  
Communicate

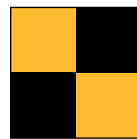

**L-Lima**  
Stop Instantly



**M-Mike**  
I Am Stopped

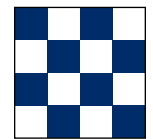

**N-November**  
No



**O-Oscar**  
Man  
Overboard



**P-Papa**  
About To Sail

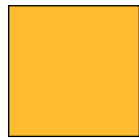

**Q-Quebec**  
Request  
Pratique



**R-Romeo**  
Do Not Pass  
Ahead of Me

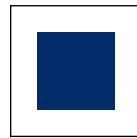

**S-Sierra**  
Engines  
Going Astern

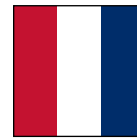

**T-Tango**  
Keep Clear

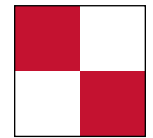

**U-Uniform**  
Standing  
Into Danger



**V-Victor**  
Require  
Assistance



**W-Whiskey**  
Require Medical  
Assistance



**X-Xray**  
Stop Your  
Intention



**Y-Yankee**  
Am Dragging  
Anchor



**Z-Zulu**  
Require A Tug



0

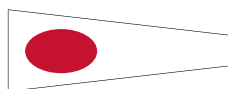

1



2

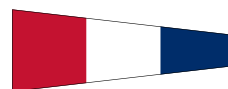

3



4



5



6



7



8



9



1st Repeater

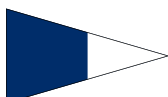

2nd Repeater

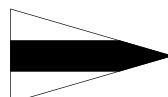

3rd Repeater

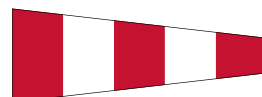

Code & Answering

# NAUTICAL FLAGS

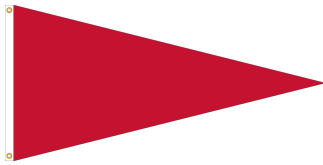

Gale Pennant

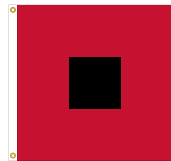

Hurricane Flag

## NYLON STORM WARNING SIGNAL FLAGS & PENNANTS

With canvas header & brass grommets

### Individual Flags

Item #	Size	Description	Price	Lbs.
080847	18" x 36"	Gale Pennant	\$16.00	.18
080848	36" x 72"	Gale Pennant	24.00	.35
080846	18" x 18"	Hurricane Flag	16.60	.20
080845	36" x 36"	Hurricane Flag	26.50	.40

### Complete Sets

Item #	Set #	Description	Price	Lbs.
080666	1	(2) 18" x 18" Hurricane Flags and (2) 18" x 36" Gale Pennants	\$57.50	.80
080667	2	(2) 36" x 36" Hurricane Flags and (2) 36" x 72" Gale Pennants	91.00	1.3



## NYLON RACE COMMITTEE FLAGS

With canvas header & brass grommets

Item #	Size	Price	Lbs.
080054	12" x 18"	\$30.30	.10
080055	20" x 30"	57.50	.25
080056	24" x 36"	63.00	.30
080057	30" x 48"	66.50	.45
080058	3' x 5'	92.50	.60
080059	4' x 6'	123.50	.90

## NYLON U.S. YACHT ENSIGNS

With canvas header & brass grommets

Item #	Size	Description	Price	Lbs.
080005	30" x 48"	Appliqué Field, Sewn Stripes	\$104.00	.40
080006	3' x 5'	Appliqué Field, Sewn Stripes	\$109.50	.60
080007	4' x 6'	Appliqué Field, Sewn Stripes	\$141.00	.80



Commodore



Vice-Commodore



Rear Commodore



Past Commodore

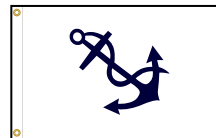

Fleet Captain



Port Captain



Treasurer



Secretary



Quartermaster



Measurer



Surgeon

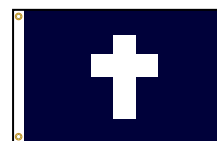

Chaplain

## 12" X 18" NYLON FLAG OFFICERS FLAGS

With canvas header & brass grommets

Item #	Description	Construction	1-5	6+	Lbs.
080032	Commodore	Fully Printed	\$33.30	\$31.70	.10
080033	Vice-Commodore	Fully Printed	33.30	31.70	.10
080034	Rear Commodore	Fully Printed	33.30	31.70	.10
080035	Past Commodore	Fully Printed	33.30	31.70	.10
080036	Fleet Captain	Fully Printed	33.30	31.70	.10
080037	Port Captain	Fully Printed	33.30	31.70	.10
080038	Treasurer	Fully Printed	33.30	31.70	.10
080039	Secretary	Fully Printed	33.30	31.70	.10
080040	Quartermaster	Fully Printed	33.30	31.70	.10
080041	Measurer	Fully Printed	33.30	31.70	.10
080042	Surgeon	Fully Printed	33.30	31.70	.10
080043	Chaplain	Fully Printed	33.30	31.70	.10



**JOLLY ROGER OUTDOOR FLAGS**

With canvas header & brass grommets

Item #	Size	Material	1-5	6+	Lbs.
080674	12" x 18"	Nylon	\$16.00	\$14.30	.10
080676	2' x 3'	Nylon	34.20	31.10	.25
080678	3' x 5'	Nylon	60.50	57.00	.45
080679	4' x 6'	Nylon	87.50	85.50	.70
080680	5' x 8'	Nylon	134.00	127.00	1.0



**JOLLY ROGER OUTDOOR BOW PENNANT**

With canvas header & brass grommets

Item #	Size	Material	1-11	12+	Lbs.
080687	10" x 15"	Nylon	\$12.90	\$11.50	.10



**BRITISH RED ENSIGN**

Nylon with canvas header & grommets

Item #	Size	Price	Lbs.
080672	12" x 18"	\$21.60	.10



**BAHAMAS MERCHANT**

Nylon with canvas header & grommets

Item #	Size	Price	Lbs.
080669	12" x 18"	\$21.60	.10



**BERMUDA MERCHANT**

Nylon with canvas header & grommets

See [page 35](#) (Bermuda) for sizes and pricing.

**NYLON BOAT FLAGS WITH CANVAS HEADER & BRASS GROMMETS**



**SKIN DIVER**



**QUARANTINE**



**ABSENT**

Size	Item #	Price	Lbs.	Item #	Price	Lbs.	Item #	Price	Lbs.
10" x 15"	080644	\$16.60	.07	080649	\$9.70	.07	080652	\$9.70	.07
12" x 18"	080645	18.20	.10	150059	11.00	.10	150030	11.00	.10
16" x 24"	080646	27.50	.15	080650	13.60	.15	080653	13.60	.15
20" x 30"	080647	28.70	.20	080651	16.00	.20	080654	16.00	.20
24" x 36"	080648	41.70	.25	150137	18.50	.25	150108	18.50	.25



**GUEST**



**PROTEST**

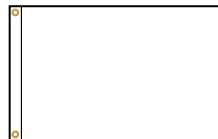

**DINNER**

Size	Item #	Price	Lbs.	Item #	Price	Lbs.	Item #	Price	Lbs.
10" x 15"	080661	\$16.60	.07	080658	\$9.70	.07	080655	\$9.70	.07
12" x 18"	080662	18.20	.10	150069	11.00	.10	150001	11.00	.10
16" x 24"	080663	27.50	.15	080659	13.60	.15	080656	13.60	.15
20" x 30"	080664	28.70	.20	080660	16.00	.20	080657	16.00	.20
24" x 36"	080665	41.70	.25	150147	18.50	.25	150079	18.50	.25

**12" X 18" NYLON OUTDOOR NOVELTY BOAT FLAGS**

With canvas header & brass grommets

Size	Material	1-11	12+	Lbs.
12" x 18"	Nylon	\$13.70	\$12.10	.07



Beer Mug  
080695



Cocktail Time  
080696



19th Hole  
080703



Skunk  
080705



Wife On Board  
080712

# SPECIALTY FLAGS

CELEBRATION

## 3' X 5' NYLON OUTDOOR SPECIAL OCCASION FLAGS

With canvas header & brass grommets

\*Limited quantities available

1-5	6+	Lbs.
\$43.50	\$40.00	.45



090001 – "Happy Valentine's"



090023 – "Spring Flowers"



090005 – "Easter Eggs"



\*090006 – "Happy Easter"

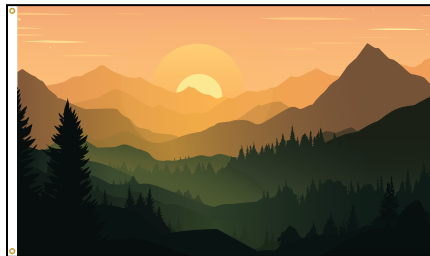

090018 – "Summer Mountains"



090015 – "Fall Harvest"



090011 – "Pumpkin"



090012 – "Witch"

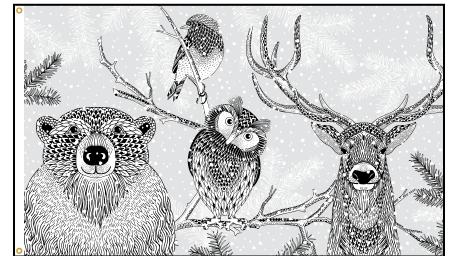

090024 – "Winter Time"



090016 – "Merry Christmas"



090017 – "Happy Holidays"



090068 – "Made in USA"

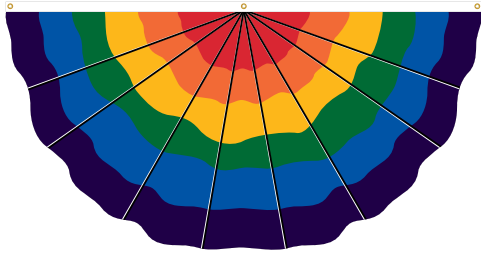

**RAINBOW FLAGS & PLEATED FANS**

With canvas header & brass grommets

**Outdoor Flag**

Item #	Size	Material	1-5	6+	Lbs.
090043	16" x 24"	O/D Nylon	\$21.20	\$18.10	.15
090044	2' x 3'	O/D Nylon	31.50	29.00	.30
090045	3' x 5'	O/D Nylon	42.00	38.50	.55
090046	4' x 6'	O/D Nylon	55.50	53.00	.80
090047	5' x 8'	O/D Nylon	109.00	106.00	1.2
090048	6' x 10'	O/D Nylon	143.00	136.00	1.7

**Outdoor Fan**

Item #	Size	Material	1-2	6+	Lbs.
090049	3' x 6'	O/D Nylon	\$73.50	\$67.50	.95



**JUNETEENTH**

With canvas header & brass grommets

Item #	Size	Material	1-5	6+	Lbs.
060748	3' x 5'	O/D Nylon	\$65.00	\$58.50	.45

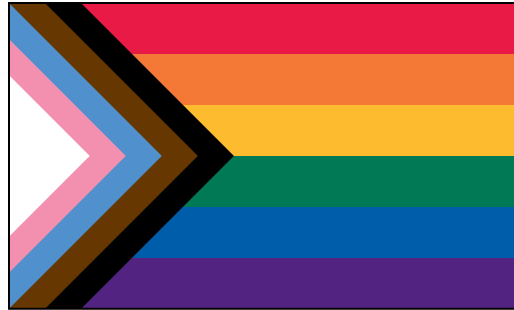

**PROGRESS PRIDE**

With canvas header & brass grommets

Item #	Size	Material	1-5	6+	Lbs.
090069	2' x 3'	O/D Nylon	\$48.50	\$43.00	.25
090066	3' x 5'	O/D Nylon	74.50	67.50	.45
090067	4' x 6'	O/D Nylon	106.00	95.50	.80
090070	5' x 8'	O/D Nylon	151.00	146.00	1.25

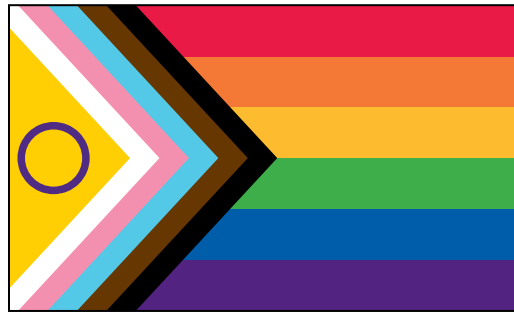

**INTERSEX-INCLUSIVE PRIDE**

With canvas header & brass grommets

Item #	Size	Material	1-5	6+	Lbs.
090071	2' x 3'	O/D Nylon	\$48.50	\$43.00	.25
090072	3' x 5'	O/D Nylon	74.50	67.50	.45
090073	4' x 6'	O/D Nylon	106.00	95.50	.75
090074	5' x 8'	O/D Nylon	151.00	146.00	1.25

# SPECIALTY FLAGS

MESSAGE

## 3' X 5' NYLON HORIZONTAL MESSAGE FLAGS

With canvas header & brass grommets

1-11	12-23	24+	Lbs.
\$36.50	\$35.50	\$33.50	.45



120000

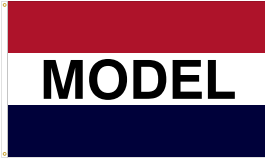

120040



120046



120047



120048



120054



120055



120063



120086

## 3' X 5' BLANK MESSAGE FLAG

Item #	Description	1-11	12-23	24+	Lbs.
120091	Red White & Blue	\$31.50	\$30.50	\$29.00	.45



## 5' DISPLAY POLES

- Poles come with wood ball & Nev-R-Wrap™ rotating tube
- Wood weight: 1.5 lbs.
- Fiberglass weight: 1.7 lbs.

Item #	Description	1-5	6+
100056	Natural Wood	\$19.30	\$18.00
100058	White Fiberglass	29.50	28.00

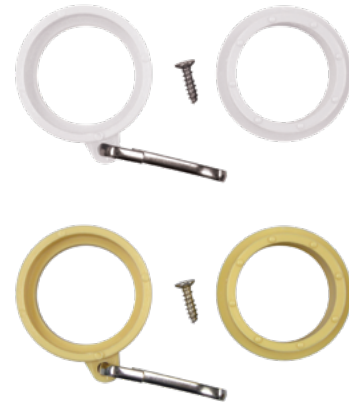

## 37" ROTATING TUBES

- Outside diameter: 1-1/4"
- Inside diameter: 1-3/16"

Item #	Color	1-5	6+	Lbs.
100062	Beige	\$2.96	\$2.72	.16
100063	White	2.96	2.72	.16



## POLE RINGS

Sold in complete sets only as shown.

- 15/16" weight: .03 lbs.
- 1" weight: .02 lbs.

Item #	For Pole Dia.	Color	1-5	6+
100059	15/16"	Beige	\$2.96	\$2.72
100060	15/16"	White	2.96	2.72
100061	1"	White	2.96	2.72



**9' X 1" ROTATING POLE WITH LAWN SOCKET**

This white painted aluminum 2-piece pole is your ultimate choice for a display pole. The top rotates on ball bearings so the flag will never tangle. For the easiest and most versatile installation, this pole comes with two flag fasteners for flying a grommeted flag and also with a snap and swivel ring for displaying flags with a pole sleeve and tab. The pole comes complete with a galvanized steel lawn socket.

Item #	1-11	12-35	36+	Lbs.
324178	\$78.50	\$68.90	\$65.40	3.3



120112

**5' X 3' NYLON VERTICAL MESSAGE FLAG**

With canvas header & brass grommets

See [page 88](#) for pricing of blank message flags.

1-11	12-23	24+	Lbs.
\$36.50	\$35.50	\$33.50	.45



We Speak Spanish  
120105



We Finance  
120103

**3' X 5' SPANISH NYLON MESSAGE FLAGS**

With canvas header & brass grommets

1-11	12-23	24+	Lbs.
\$36.50	\$35.50	\$33.50	.45



**NYLON BLACK & WHITE OPEN CHECKERED FLAG**

With canvas header & brass grommets

Item #	Size	1-5	6+	Lbs.
120202	3' x 5'	\$57.00	\$55.50	.45

# SPECIALTY FLAGS

## 24" X 30" OFFICIAL SIZE NYLON AUTO RACING FLAGS

- Mounted flags come on 15/16" x 52" wood pole
- Pole sleeve and grommets flags are unmounted

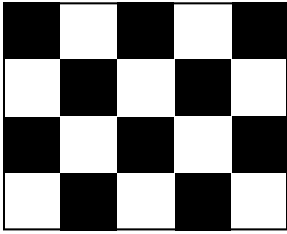

### End of Race (Printed)

Item #	Style	1-5	6+	Lbs.
110007	Mounted	\$40.00	\$38.50	1.0
110015	Pole Sleeve	32.50	30.50	.20
110023	Grommets	36.00	35.00	.25

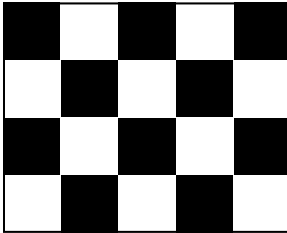

### End of Race (Sewn)

Item #	Style	1-5	6+	Lbs.
110006	Mounted	\$72.00	\$66.50	1.1
110014	Pole Sleeve	69.50	63.50	.30
110022	Grommets	71.00	64.50	.35

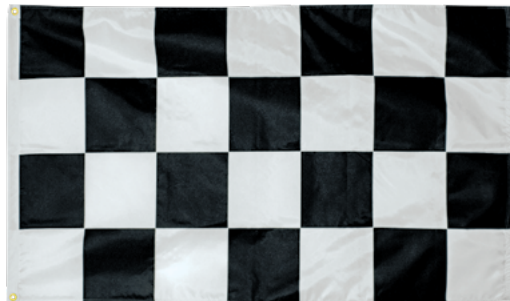

## FULLY PRINTED OUTDOOR BLACK & WHITE CHECKERED FLAGS

With canvas header & brass grommets

Item #	Size	Material	1-5	6+	Lbs.
110057	2' x 3'	Nylon	\$50.00	\$43.50	.25
110058	3' x 5'	Nylon	80.00	71.00	.45
110059	4' x 6'	Nylon	98.00	89.00	.70
110060	5' x 8'	Nylon	141.00	128.00	1.0

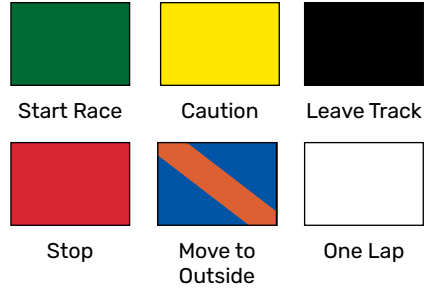

## 4" X 5" PLASTIC (INDIVIDUAL FLAGS)

Mounted on 3/16" x 10" gold plastic staff with gold spear

Item #	Description	1-143	144+	Lbs.
110027	Start Race	\$0.58	\$0.50	.02
110028	Caution	0.58	0.50	.02
110029	Leave Track	0.58	0.50	.02
110030	Stop	0.58	0.50	.02
110031	Move To Outside	0.58	0.50	.02
110032	One Lap To Finish	0.58	0.50	.02

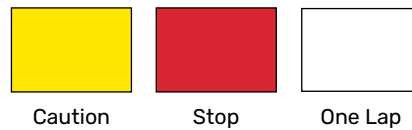

## 4" X 5" ENDURA-GLOSS™ (INDIVIDUAL FLAGS)

Mounted on 3/16" x 10" black plastic staff with gold spear

♦ Sold By The Dozen

Item #	Description	♦ 1-11 Doz	♦ 12+ Doz	Lbs.
110035	Caution	\$31.20	\$28.08	.36
110037	Stop	31.20	28.08	.36
110039	One Lap To Finish	31.20	28.08	.36

### 14" X 20" BLANK NYLON GOLF FLAGS

Other colors and custom designed golf flags available upon request. Call for pricing.

#### Grommet Style

Canvas header, 3 brass grommets & 3 cloth tie tapes

Color	Item #	1-9	10-18	19-27	28+	Lbs.
White	110133	\$11.00	\$10.20	\$10.10	\$10.00	.08
Royal Blue	110135	11.00	10.20	10.10	10.00	.08
Canada Red	110137	11.00	10.20	10.10	10.00	.08
Fm Yellow	110134	11.00	10.20	10.10	10.00	.08
Orange	110136	11.00	10.20	10.10	10.00	.08



#### Tube Style

Mounted on thermo-plastic rotating tube

Color	Item #	1-9	10-18	19-27	28+	Lbs.
White	110303	\$21.10	\$20.50	\$20.40	\$19.10	.19
Royal Blue	110305	21.10	20.50	20.40	19.10	.19
Canada Red	110307	21.10	20.50	20.40	19.10	.19
Fm Yellow	110304	21.10	20.50	20.40	19.10	.19
Orange	110306	21.10	20.50	20.40	19.10	.19

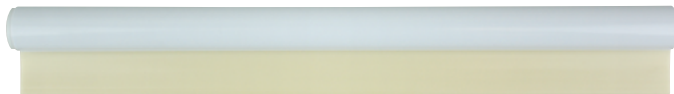

### GOLF FLAG ROTATING TUBES ONLY

Item #	1-18	19-36	37-108	109+	Lbs.
110308	\$11.00	\$10.20	\$9.70	\$8.70	.95



## HONORING THE AMERICAN FLAG: HOW TO RETIRE IT WITH DIGNITY

Every precaution should be taken to prevent the flag from becoming soiled. When a flag is in such a condition, through wear or damage, that is no longer a fitting emblem for display, it should be destroyed privately in a dignified manner.

The flag should **NEVER**

1. Be tilted (dipped) even momentarily to any person or thing. Regimental colors, State flags, organization or institutional flags may be tilted as the mark of honor.
2. Be displayed with the union down except as a signal of distress.
3. Be carried flat or horizontally, but always aloft and floating free.
4. Be displayed on a float, motor car or boat except from a staff.
5. Be allowed to touch the ground or floor, or brush against objects.
6. Have objects placed on, over it, or be used as a covering for a ceiling.
7. Have any mark, insignia, letter, work, figure, picture or drawing of any nature placed upon or attached to it.
8. Be used as a receptacle for carrying anything, or be used to cover a statue or monument. If used in connection with unveiling ceremonies, it should not serve as a covering of the object being unveiled.
9. Be used for advertising purposes or have advertising signs fastened to its staff or halyard.
10. Be embroidered on such articles as handkerchiefs or cushions, or be printed or otherwise impressed on boxes.
11. Be used as a costume or athletic uniform or part of one.
12. Be used as drapery of any sort whatsoever, never festooned, drawn back or up in folds, but always allowed to fall free. Bunting of blue, white and red—always arranged with the blue above, white in the middle, and red below—should be used for such purposes of decoration as covering a speaker's desk or draping the front of a platform.

# ATTENTION FLAGS

SOLID COLOR

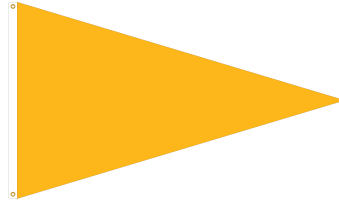

## NYLON SOLID COLOR FLAGS

Canvas header & brass grommets

Size	1-11	12-23	24+	Lbs.
12" x 18"	\$11.00	\$10.30	\$10.00	.08
2' x 3'	18.50	18.20	17.50	.25
3' x 5'	31.20	30.20	29.30	.45
4' x 6'	47.40	46.60	45.70	.70
5' x 8'	71.90	67.00	65.20	1.0
6' x 10'	106.10	99.10	96.20	1.5

## NYLON SOLID COLOR PENNANTS

Canvas header & brass grommets

Size	1-11	12-23	24+	Lbs.
12" x 18"	\$11.00	\$10.30	\$10.00	.06
2' x 3'	19.70	18.10	17.40	.15
3' x 5'	27.10	25.60	24.60	.30
4' x 6'	48.20	45.00	43.60	.40
4' x 9'	56.40	52.50	51.30	.50
5' x 8'	66.80	62.50	60.90	.60

WHITE 300000	IRISH GREEN 300002
ROYAL BLUE 300008	PURPLE 300009
O.G. BLUE 300011	FM YELLOW 300015
ORANGE 300018	CANADA RED 300019
O.G. RED 300020	BLACK 300025

# FEATHER FLAG ACCESSORIES

FEATHER & TEAR DROP ACCESSORIES

## TELESCOPING SUPERFLEX™ POLES

For 12' x 26" feather flags

These fiberglass flagpoles sway in the breeze producing a dramatic, attention-getting display. Available in both 15' and 21' exposed height sizes. The 15' pole is adjustable from 6' to 15' while the 21' pole is adjustable from 8' to 21'. Poles come with 21" PVC ground sleeve and easy-to-follow instructions.

Item #	Ht.	Color	Butt Dia.	Top Dia.	1-11	12+	Lbs.
323442	15'	White	1-1/4"	3/4"	\$155.00	\$134.00	5.4
323443	21'	White	1-1/4"	3/4"	164.00	142.00	7.4
324172	15'	Black	1-1/4"	3/4"	155.00	134.00	5.4
324173	21'	Black	1-1/4"	3/4"	164.00	142.00	7.4

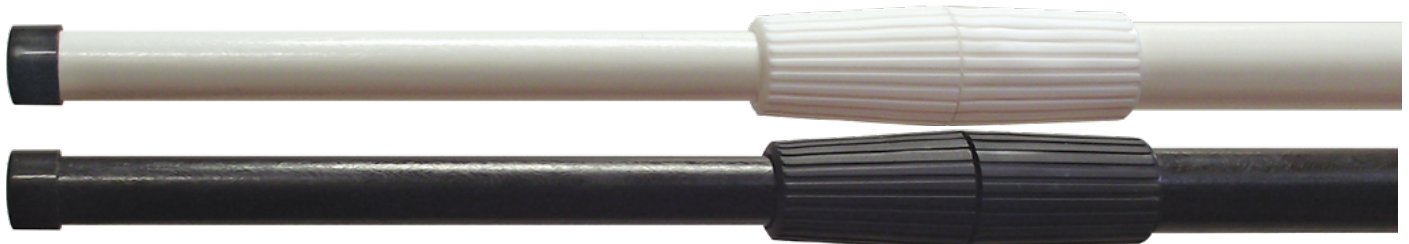

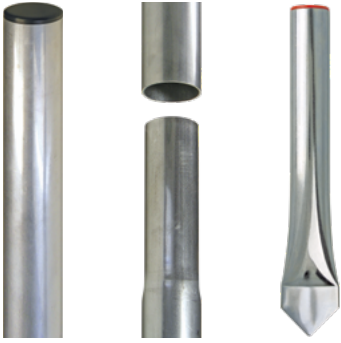

**ALUMINUM FEATHER FLAGPOLE**

For 7' x 17" feather flags

This set comes with a two section 1" diameter silver mill finish pole - a 4' bottom and a 5' top plus a galvanized steel fabricated lawn socket. The top of the pole is capped with a plastic top plug to protect the top of the Feather Flag from premature wear.

Item #	Ht.	Color	1-11	12+	Lbs.
324185	9'	Silver	\$57.00	\$53.00	1.6

**REPLACEMENT GROUND SLEEVES FOR TELESCOPING SUPERFLEX POLES**

Item #	Length	Price	Lbs.
324187	21"	\$13.00	.30



**TEAR DROP FLAG ACCESSORIES**



**TEAR DROP POLE IN-GROUND MOUNT**

Once installed in the ground, the Tear Drop Flag Pole slips over a rotating spindle. The Tear Drop Pole In-Ground Mount measures a total of 23-3/8" long, with 16" of length under the rotating spindle.

Item #	1-5	6-11	12+	Lbs.
155528	\$64.00	\$61.00	\$55.00	3.2



**TEAR DROP FLAGPOLE**

These continuous tapering, flexible black fiberglass flagpoles measure 14' when fully assembled. The bottom measures 1" and tapers to 1/4" at the top. This 3-piece pole swedges together perfectly and all swedge points are reinforced with stainless steel fittings. Pole is rubber tipped to prevent flag damage. Comes complete with heavy-duty, black canvas carry bag.

Item #	1-5	6-11	12+	Lbs.
155527	\$138.00	\$132.00	\$114.00	3.7



**TEAR DROP POLE SURFACE MOUNT**

This rotating base can be permanently mounted or can be temporarily held in place with a heavy-duty water donut. When filled, the water donut holds 2-1/4 gallons of water and weighs 18-1/2 pounds. This water donut installation should only be used when winds do not exceed 5 m.p.h.

Item #	1-5	6+	Lbs.
155529	\$111.00	\$107.00	8.6

### CUSTOM PRINTED FLAGS AND BANNERS

Any design and quantity can be printed using our direct print digital/dye sub process. The possibilities are endless with no limit on colors or types of image.

Outdoor flags up to size 6' x10' are finished standard with heavy duty canvas header and two brass grommets. On 8' x 12' and larger flags will be finished with roped header and thimbles.

Other finishing options are available upon request.



## ARTWORK REQUIREMENTS

For a prompt approval process please provide the following:

- ✓ For a clean printed image Vector art is required
- ✓ All fonts and strokes are outlined
- ✓ Spell checked for errors and proof the art
- ✓ For maximum color match include solid coated Pantone® colors

• Note: undefined process colors may not print as previewed

Preferred and accepted file formats for artwork submission:

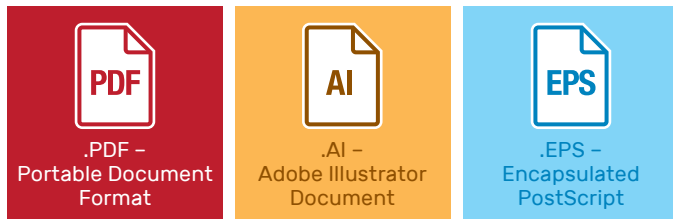

## MATERIAL OPTIONS

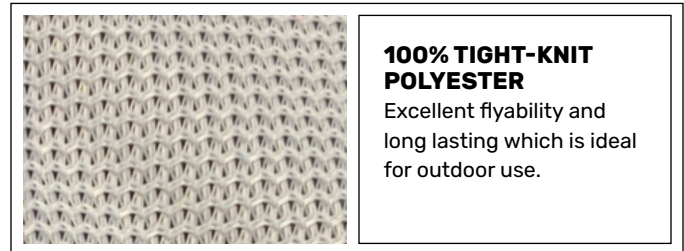
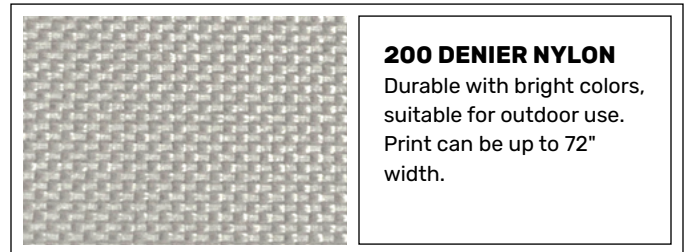

## PRINTING OPTIONS

### SINGLE REVERSE

Printed on front side with full ink penetration. On the reverse side, the image will appear backwards.



### DOUBLE-SIDED

Two flags printed and sewn together back to back with a heavy duty block out liner in between.





## CRAFTED FOR VIBRANT, LASTING BEAUTY

At Eder Flag, we've been expertly handcrafting appliqué flags and banners for generations. Our skilled artisans bring your logo or design to life – whether it's a small piece or a jumbo showstopper. Let us transform your vision into a bold, high-impact display that stands out.

### APPLIQUED FLAGS

Appliqué is a method of layering fabric on top of fabric for the most vibrant and colorful display. The quality and detailed artistry of these flags exceed any printing style. These unique stitched flag creations are designed and hand-crafted with the finest workmanship in the industry. With appliqué, our expert sewing team individually assembles and stitches each item.

Custom Appliqued flags are individually hand-sewn using 200-denier nylon or 2-ply polyester. Appliqué is for indoor or outdoor flags, corporate logo flags, table banners, parade banners, or any other flag or banner. It also offers the opportunity to enhance existing flags or banners. Appliqued years or names can be added without producing a new banner.

### ORDERING AND PRICING GUIDELINES

- Dealer must provide completed vector art before quoting for all custom appliqued items.
- Make requests and questions via email only to [customdepartment@ederflag.com](mailto:customdepartment@ederflag.com).
- No quantity minimums at this time.
- All sales are final – there is no cancellation once the order is processed.
- Eder reserves the right to decline to quote.
- Lead times will vary depending on the project and production schedules.
- Prices are valid for 30 days from the date of the completed quote.

**DELUXE BANNER ARM MOUNTING SETS**

Each set contains cast aluminum mounting bracket(s) with stainless steel mounting straps. Crossbars are fabricated from 1-1/2" outside diameter clear anodized aluminum poles with white end caps for a finished look. Ideal for round poles. For square poles, see U-Bolts on [page 98](#).

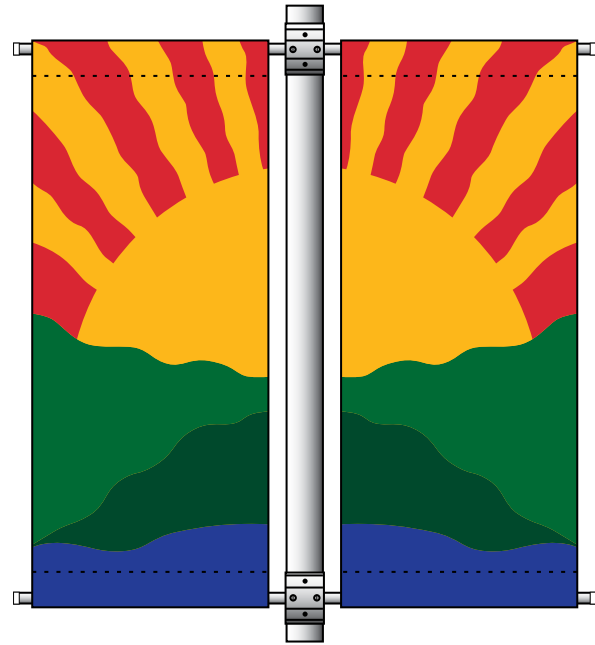
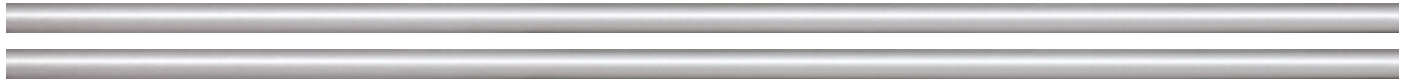

**DCA MOUNTING SETS**

Each DCA Mounting Set is designed for use with a pair of banners with pole hems at both the top and bottom. Priced per set.

Item #	Model	Rec. Banner Width	Rec. Banner			Lbs.
			1-24	25-49	50+	
310012	DCA18	18"	\$222.00	\$204.00	\$197.00	8.2
310013	DCA24	24"	249.00	228.00	214.00	9.4
310014	DCA30	30"	254.00	236.00	222.00	11
310015	DCA36	36"	281.00	259.00	244.00	12

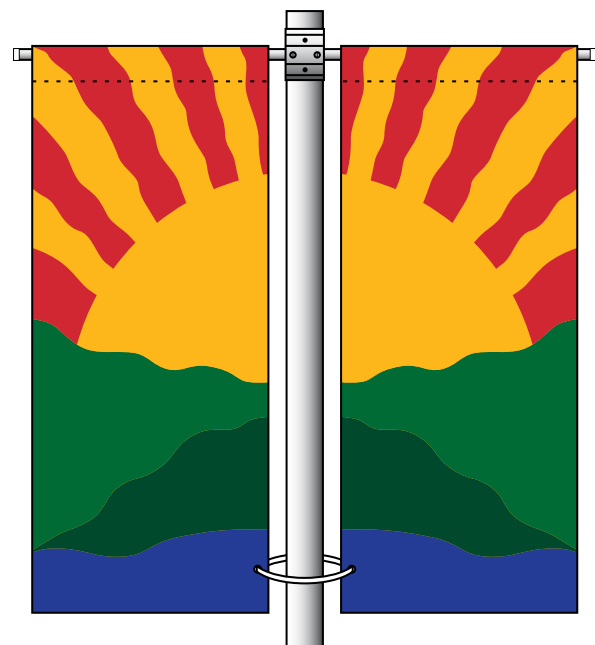

**DCA/G MOUNTING SETS**

Each DCA/G Mounting Set is designed for use with a pair of banners with pole hems at the top and grommets at the bottom. Priced per set.

Item #	Model	Rec. Banner Width	Rec. Banner			Lbs.
			1-24	25-49	50+	
310016	DCA18/G	18"	\$137.00	\$125.00	\$113.00	4.2
310017	DCA24/G	24"	140.00	131.00	116.00	4.8
310018	DCA30/G	30"	154.00	145.00	137.00	5.4
310019	DCA36/G	36"	167.00	154.00	145.00	6.0

# BRACKETS, HOLDERS & ACCESSORIES

## SCA MOUNTING SETS

Each SCA Mounting Set is designed for use with a single banner with pole hems at both the top and bottom. Priced per set.

Item #	Model	Rec. Banner			Lbs.	
		Width	1-24	25-49		50+
310020	SCA18	18"	\$184.00	\$171.00	\$155.00	5.0
310021	SCA24	24"	189.00	176.00	161.00	5.7
310022	SCA30	30"	197.00	187.00	171.00	6.3
310023	SCA36	36"	204.00	192.00	181.00	6.9

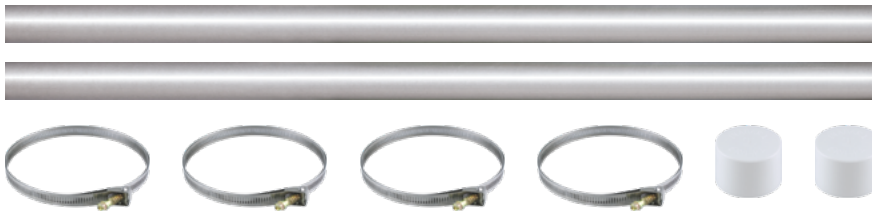
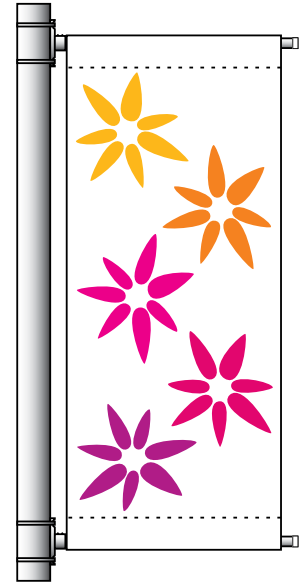

## SCA/G MOUNTING SETS

Each SCA/G Mounting Set is designed for use with a single banner with a pole hem at the top and a grommet at the bottom. Priced per set.

Item #	Model	Rec. Banner			Lbs.	
		Width	1-24	25-49		50+
310024	SCA18/G	18"	\$111.00	\$104.00	\$98.00	5.0
310025	SCA24/G	24"	113.00	108.00	99.00	5.7
310026	SCA30/G	30"	118.00	112.00	108.00	6.3
310027	SCA36/G	36"	137.00	125.00	111.00	6.9

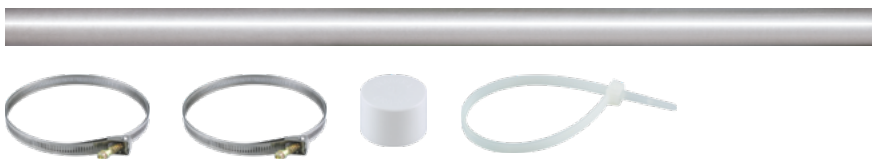
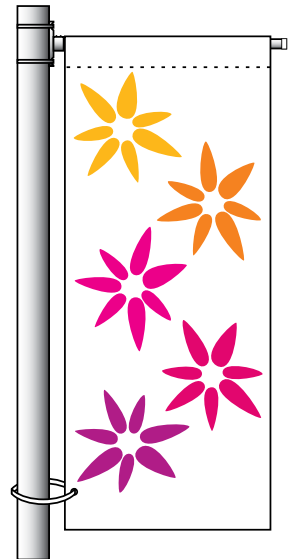

## POLES ONLY FOR DELUXE BANNER ARMS

### Single Banner

Item #	Rec. Banner		Dia.	Wall	Price	Lbs.
	Width	Length				
310033	(1) 18"	24"	1-1/2"	.125	\$32.00	1.3
310034	(1) 24"	30"	1-1/2"	.125	34.50	1.6
310035	(1) 30"	36"	1-1/2"	.125	41.50	1.9
310036	(1) 36"	42"	1-1/2"	.125	46.50	2.2

### Double Banner

310037	(2) 18"	48"	1-1/2"	.125	\$53.00	2.5
310038	(2) 24"	60"	1-1/2"	.125	69.00	3.1
310039	(2) 30"	72"	1-1/2"	.125	89.00	3.7
310040	(2) 36"	84"	1-1/2"	.125	96.00	4.3



## U-BOLTS FOR SQUARE POLES

Each U-Bolt comes complete with washers, lock washers, nuts & back plate. Two U-Bolts per bracket are required. Priced per U-Bolt.

Item #	Pole Size	1-24	25-49	50+	Lbs.
310030	4" Square	\$21.00	\$17.90	\$16.90	.45
310032	6" Square	42.20	36.80	35.00	.60

## BRACKETS, HOLDERS & ACCESSORIES



### ORNAMENT ADAPTER

This aluminum adapter must be installed at the factory & will accept any ornament with a spindle threading of 1/2"-13NC.

Priced per adapter

Item #	Price	Lbs.
310041	\$68.00	.15



### PLASTIC END CAPS

Item #	Color	1-24	25-49	50+	Lbs.
310042	White	\$1.36	\$1.00	\$0.76	.15
310163	Black	1.36	1.00	0.76	.15



### BRACKETS FOR DELUXE BANNER ARM SETS

With 2 Stainless Steel Straps Per Bracket

Priced per bracket

Item #	For Pole		1-24	25-49	50+	Lbs.
	Dia.	Style				
310028	1-1/2"	Single Deluxe	\$56.00	\$51.50	\$48.00	1.0
310029	1-1/2"	Double Deluxe	59.00	56.00	51.50	1.3
310143	1"	Single Deluxe	56.00	53.00	49.50	1.3
310144	1"	Double Deluxe	79.00	74.00	69.00	1.6
310139	1"	Double Mini	43.50	42.00	39.50	.49

No Straps

Priced per bracket

Item #	For Pole		1-24	25-49	50+	Lbs.
	Dia.	Style				
310145	1-1/2"	Single Deluxe	\$41.50	\$34.50	\$33.00	.96
310146	1-1/2"	Double Deluxe	44.00	41.50	38.50	1.3
310149	1"	Single Deluxe	43.00	38.50	34.50	.85
310150	1"	Double Deluxe	46.50	43.00	41.50	1.2
310148	1"	Double Mini	33.00	30.00	28.00	.45

### STREETSCAPE MOUNTING KITS

These Streetscape Mounting Kits contain everything you'll need to mount a flag onto an existing street or light pole. Can be used on round poles up to 12" in diameter.

#### INCLUDED IN KIT:

- Silver stainless steel bracket
- 2 Stainless steel mounting straps
- 6' Clear anodized heavy wall aluminum pole
- White NeverFurl kit
- Silver plastic acorn
- (OPTIONAL) 3' x 5' U.S. Nylon Flag

Item #	Feature	1-49	50+	Lbs.
310164	No Flag	\$131.00	\$119.00	3.2
310165	With Flag	182.00	164.00	3.7



# BRACKETS, HOLDERS & ACCESSORIES



Standard Screw Mount Installation

## ULTIMATE ADJUSTABLE BRACKETS

- Adjusts to 13 different positions including vertical & horizontal
- For 1" diameter poles
- EZ-Grip thumb screw
- Built-in windsock holder for 1/4" diameter pole
- Screw holes for mounting to flat surface (mounting screws included)
- Slots for strap mounting onto a pole (mounting straps sold separately)



With Stainless Steel Mounting Straps

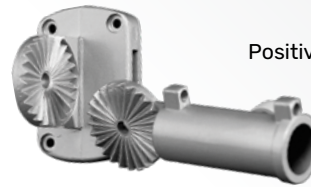

Positive Lock Fan Gears

Item #	Model	Color / Material	1-71	72-143	144+	Lbs.
310043	SU-AJB	Silver Painted Aluminum	\$28.30	\$24.50	\$21.50	.85

Item #	Model	Color / Material	1-71	72-143	144+	Lbs.
310044	WU-AJB	White Painted Aluminum	\$28.30	\$24.50	\$21.50	.85

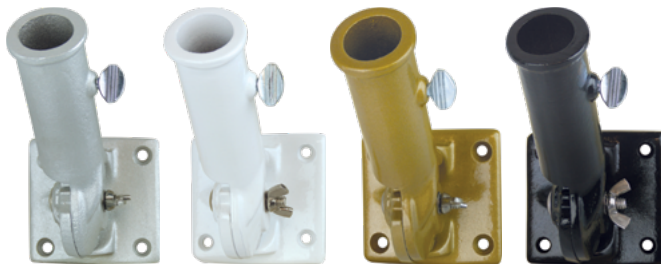

## STANDARD ALUMINUM ADJUSTABLE BRACKETS

- Supplied with thumb screw
- Displays pole at vertical, 25°, 50°, 65° or horizontal
- For 1" diameter poles

Item #	Model	Color	1-23	24-143	144+	Lbs.
310046	AJB	Silver	\$28.10	\$25.20	\$24.70	.85
310047	AJB-W	White	33.20	30.30	28.90	.85
310048	AJB-G	Gold	36.20	33.20	32.30	.85
310049	AJB-B	Black	34.30	30.20	29.60	.85

## ALUMINUM MULTI-PURPOSE BRACKETS

- Supplied with thumb screw
- Displays pole at 45° or horizontal
- For 1" diameter poles

Item #	Model	Color	1-23	24-143	144+	Lbs.
310052	MPB	Silver	\$25.00	\$22.20	\$21.40	.50
310053	MPB-W	White	28.60	25.70	24.70	.50
310054	MPB-G	Gold	36.50	32.80	30.80	.50
310141	MPB-B	Black	30.90	26.60	24.50	.50

## ADAPTER FOR STANDARD ALUMINUM ADJUSTABLE BRACKETS

Fits into the shaft of the AJB to accommodate a 3/4" diameter pole.



Item #	Color	1-23	24-143	144+	Lbs.
310050	Gray	\$2.74	\$2.28	\$2.22	.04

# BRACKETS, HOLDERS & ACCESSORIES

## NYLON MULTI-PURPOSE BRACKETS

- Supplied with thumb screw
- Displays pole at 45° or horizontal
- For 1" diameter poles



Item #	Color	1-23	24-143	144+	Lbs.
310055	White	\$10.00	\$8.40	\$7.80	.25



## STAINLESS STEEL MOUNTING STRAPS

Item #	Model	For Pole		1-23	24-143	144+	Lbs.
		Dia.	Length				
310074	SSS-85	8-1/2"	27-3/4"	\$10.60	\$8.20	\$6.90	.18
310075	SSS-12	12"	39-1/2"	16.30	12.60	11.70	.20
310140	SSS-16	16"	52"	19.10	15.00	14.00	.40

## ALUMINUM MULTI-ANGLE BRACKETS

- Supplied with set screws
- Displays pole at vertical, 45° or horizontal
- For 1" diameter poles



Item #	Color	1-23	24-143	144+	Lbs.
310134	Gold	\$63.50	\$51.50	\$50.00	.65

## ALUMINUM SCHOOL BRACKET

- Displays pole at 45°
- For pole diameters of 1/4" thru 5/8"



Item #	Color	1-23	24-143	144+	Lbs.
310082	Silver	\$4.92	\$4.14	\$3.94	.05



## STAMPED STEEL BRACKETS

Displays pole at a 45° angle

Model	For Pole Dia.	Lbs.	Silver						Gold		
			Item #	1-71	72-143	144+	Item #	1-71	72-143	144+	
SSB-12	1/2"	.10	310056	\$4.06	\$3.00	\$2.82	310060	\$5.00	\$4.16	\$3.98	
SSB-34	3/4"	.16	—	—	—	—	310061	5.28	4.26	4.08	
SSB-34HD	3/4"	.25	310151	5.90	4.90	4.70	—	—	—	—	
SSB-10	1"	.36	310058	8.60	6.80	6.50	—	—	—	—	
SSB-114	1-1/4"	.37	310059	13.70	9.60	8.80	310063	15.80	11.80	11.20	

## WB ALUMINUM BRACKETS

- Displays pole at a 45° angle
- WB-400 supplied with thumb screw

Item #	Model	Color	For Pole Dia.	1-71	72-143	144+	Lbs.
310064	WB-100	Silver	1/2"	\$9.80	\$7.90	\$7.40	.10
310065	WB-200 S	Silver	3/4"	12.30	8.90	8.60	.15
310136	WB-200 WH	White	3/4"	14.30	11.20	10.90	.15
310066	WB-400	Silver	15/16" - 1"	17.20	15.20	14.60	.30



# BRACKETS, HOLDERS & ACCESSORIES

## WB CAST BRASS BRACKET

- Displays pole at a 45° angle
- Polished mirror finish
- Supplied with set screw



Item #	Model	For Pole Dia.	For Pole			Lbs.
			1-71	72-143	144+	
310124	WB-200-CB	3/4"	\$44.50	\$41.00	\$34.50	.50
310067	WB-400-CB	1"	69.00	53.00	52.00	1.1

## ALUMINUM ELECTRIC WAY BRACKET

- Displays pole at a 45° angle
- Supplied with thumb screw



Item #	Model	Color	For Pole Dia.	For Pole			Lbs.
				1-71	72-143	144+	
310070	EWB	Silver	1"	\$27.10	\$21.70	\$20.20	.40

## EWC ALUMINUM BRACKETS

- Displays pole at a 35° angle
- Can be mounted with screws or stainless steel mounting strap
- Supplied with thumb screw



Item #	Model	Color	For Pole Dia.	For Pole			Lbs.
				1-71	72-143	144+	
310068	EWC-S	Silver	1"	\$17.20	\$15.40	\$15.20	.45
310135	EWC-WH	White	1"	20.30	18.60	17.40	.45



## ALUMINUM ELECTRIC WAY BRACKET STRAPS

To be used with our EWB bracket above.

Item #	Color	For Pole Dia.	For Pole			Lbs.
			1-11	12-71	72+	
310072	Silver	6" And Smaller	\$69.00	\$56.00	\$48.00	.70

## EWC STAINLESS STEEL BRACKETS

- Displays pole at a 30° angle
- Can be mounted with screws or stainless steel mounting strap
- Supplied with thumb screw



Item #	Finish	For Pole Dia.	For Pole			Lbs.
			1-71	72-143	144+	
310069	Standard	1"	\$64.00	\$60.00	\$53.00	1.2
310125	Mirror	1"	75.00	62.00	58.50	1.2



25° pictured

## WS-100 ALUMINUM WALL SHIELD BRACKETS

Supplied with set screw

Item #	Angle	Color	For Pole Dia.	For Pole		Lbs.
				1-11	12+	
310076	25°	Silver	15/16"	\$88.00	\$82.00	1.4
310077	25°	Silver	1"	88.00	82.00	1.4
310078	25°	Silver	1-1/8"	88.00	82.00	1.4
310079	70°	Silver	15/16"	88.00	82.00	1.4
310080	70°	Silver	1"	88.00	82.00	1.4
310081	70°	Silver	1-1/8"	88.00	82.00	1.4

## ALUMINUM FINGER BRACKET

Displays poles at a 45° angle

Item #	Color	For Pole Dia.	Style	1-11	12-71	72+	Lbs.
310083	Silver	3/8"	Holds 3 Flags	\$16.00	\$15.30	\$14.20	.15



## STAMPED STEEL FINGER BRACKETS

Displays poles at a 45° angle

Item #	Color	For Pole Dia.	Style	1-11	12-71	72+	Lbs.
310085	Silver	3/8"	Holds 3 Flags	\$8.40	\$8.00	\$7.20	.20
310086	Silver	3/8"	Holds 5 Flags	11.80	11.20	10.60	.25



## STAMPED STEEL BICYCLE BRACKET

Flags pictured not included in pricing below.

Item #	Color	For Pole Dia.	Style	1-11	12-71	72+	Lbs.
310087	Silver	3/16"	Holds 5 Flags	\$3.50	\$3.34	\$3.16	.06



## PARKING METER BRACKET

Item #	Model	Color	For Pole Dia.	1-11	12-71	72+	Lbs.
310089	PMB-2	Silver	1-3/8"	\$76.00	\$73.00	\$63.00	1.2



PMB-2

## FABRICATED ALUMINUM LAWN SOCKETS

Supplied with top cap

Item #	Model	Type	For Pole Dia.	Length	1-11	12-71	72+	Lbs.
310102	ELSF-1	Aluminum	1"	10"	\$16.10	\$11.90	\$10.90	.15
310162	-	Galv. Steel	1"	9-1/2"	12.30	9.30	8.40	.42
310103	ELSF-138	Aluminum	1-3/8"	10"	18.50	14.50	12.80	.20



Aluminum



Steel

## CAST ALUMINUM LAWN SOCKETS

Supplied with top cap

Item #	Model	For Pole Dia.	Length	1-11	12-71	72+	Lbs.
310097	ELSC-1	1"	10"	\$43.00	\$41.50	\$38.50	.90
310098	ELSC-138	1-3/8"	13"	49.00	47.50	43.50	1.2



# BRACKETS, HOLDERS & ACCESSORIES



## VERTICAL HOLDERS

Supplied with thumb screw

Item #	Model	Color	For Pole Dia.	1-11	12+	Lbs.
310090	VH-1	Silver	1"	\$65.00	\$59.00	2.3
310091	RM-138	Silver	1-3/8"	116.00	112.00	3.3
310092	RM-112	Silver	1-1/2"	119.00	113.00	3.4
310093	RM-2	Silver	2"	150.00	142.00	4.0



## ALUMINUM TIRE MOUNTS

Supplied with thumb screw

Item #	Model	Color	For Pole Dia.	1-11	12+	Lbs.
310094	TM-138	Silver	1-3/8"	\$146.00	\$143.00	3.8
310095	TM-112	Silver	1-1/2"	158.00	152.00	4.0
310096	TM-2	Silver	2"	197.00	188.00	4.4



## CAST ALUMINUM CURB SOCKETS

Supplied with top cap

Item #	Model	For Pole Dia.	Length	1-11	12-71	72+	Lbs.
310099	ECSC-1	1"	6"	\$43.00	\$41.50	\$38.50	.80
310100	ECSC-138	1-3/8"	8-1/2"	49.00	47.50	43.50	.95



## CLEAR PLASTIC EZ-MOUNT™ FLAG RINGS

Priced per ring

Item #	Model	For Pole Dia.	1-11	12-71	72+	Lbs.
310104	EZ-34	3/4"	\$1.64	\$1.38	\$1.30	.02
310105	EZ-1516	15/16"	1.64	1.38	1.30	.02
310106	EZ-1	1"	1.64	1.38	1.30	.02



## NYLON FLAG TIES

Priced per tie

Item #	Model	Max. Pole Dia.	1-11	12-71	72+	Lbs.
310110	NFT4	3/4"	\$0.52	\$0.40	\$0.32	.001
310111	NFT8	2"	1.06	0.88	0.70	.004
310112	NFT12	3"	1.38	1.18	0.92	.005
310113	NFT16	4"	1.58	1.32	1.12	.020
310114	NFT22	6"	1.78	1.58	1.28	.030
310115	NFT32	9-1/4"	3.82	3.26	2.76	.050

## WALL MOUNT VERTICAL HOLDER

Supplied with set screws

Item #	Color	For Pole Dia.	Price	Lbs.
460123	Silver - Bright Zinc Plating	1"	\$90.00	1.5



**NEVERFURLS**

With NeverFurl® you can fly your flag all day long, every day of the year, and the wind will never wrap your flag around the flagpole. The NeverFurl® kit is easy to install and comes complete with everything needed including instructions and detailed drawings. No additional tools are required.

The design of the NeverFurl® device allows each rotator to work independently with the wind by moving up and down and rotating around the pole thereby eliminating flag wrapping. Works with all flag sizes regardless of changes in wind speed or wind direction.

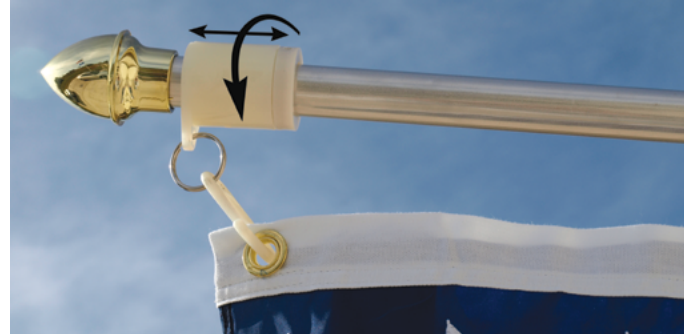

**NEVERFURL COMPLETE KITS**

**White**

Item #	For Pole Dia.	1-5	6+	Lbs.
310116	3/4"	\$31.10	\$29.20	.25
310117	1"	32.80	31.10	.35
310118	1-1/2"	43.30	41.70	.40
310119	2"	47.60	43.30	.45
310142	3"	89.00	83.00	1.1

**NEVERFURL COMPLETE KITS**

**Black**

Item #	For Pole Dia.	1-5	6+	Lbs.
310123	3/4"	\$31.10	\$29.20	.25
310137	1"	33.20	31.30	.35
310152	1-1/2"	47.60	43.30	.40

**NEVERFURL COLLAR RINGS ONLY**

**White**

Item #	For Pole Dia.	Price	Lbs.
310153	3/4"	\$7.90	.02
310154	1"	8.20	.03
310155	1-1/2"	9.60	.08
310156	2"	17.10	.03
310157	3"	20.90	.03



**NEVERFURL COLLAR RINGS ONLY**

**Black**

Item #	For Pole Dia.	Price	Lbs.
310158	3/4"	\$8.20	.03
310159	1"	9.60	.04
310160	1-1/2"	17.10	.02



**NEV-R-WRAP™ FLAG UNFURLERS**

- No more tangled flag
- Follows the wind
- Flag lasts longer
- Comes with 2 nylon flag ties, 2 Nev-R-Wrap tubes and 2 EZ-Mount flag rings

Item #	Model	For Pole Dia.	1-11	12-71	72+	Lbs.
310120	NRV-34	3/4"	\$14.00	\$13.20	\$11.60	.10
310121	NRV-1516	15/16"	14.00	13.20	11.60	.10
310122	NRV-1	1"	14.00	13.20	11.60	.10



# OUTDOOR FLAGPOLES

RESIDENTIAL FLAGPOLES

## ALUMINUM ANTI-FURL ROTATING POLES

These 2-piece poles are available in a anodized aluminum, white painted or wood grain finish. The top of the pole rotates on ball bearings so the flag won't tangle. There's no need for an unfurling tube.

These poles come with 2 flag fasteners (for flying a grommeted flag) and a snap (for flying flags with a pole sleeve and tab). Use with brackets that accept a 1" outside diameter pole (not included). All poles are supplied with a gold ball ornament except item number 324207.

Item #	Length	Finish	1-11	12-35	36+	Lbs.
324174	5'	Silver	\$45.20	\$42.80	\$39.00	2.1
324175	5'	White	47.50	45.70	41.30	2.1
324176	5'	Wood Grain	54.50	49.30	45.50	2.1
324100	6'	Silver	45.00	43.50	40.00	2.3
324207	6'	Silver/Silver Ball	45.00	43.50	40.00	2.3
324105	6'	White	47.60	45.60	41.40	2.3
324116	6'	Wood Grain	53.00	48.00	45.50	2.3

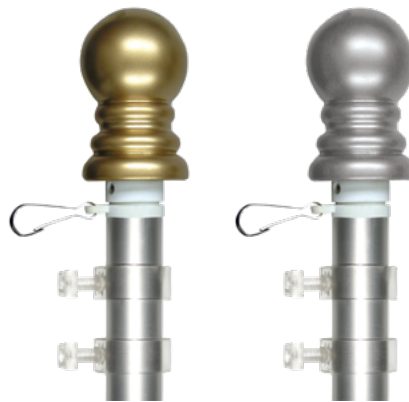

Silver

(6' Only)

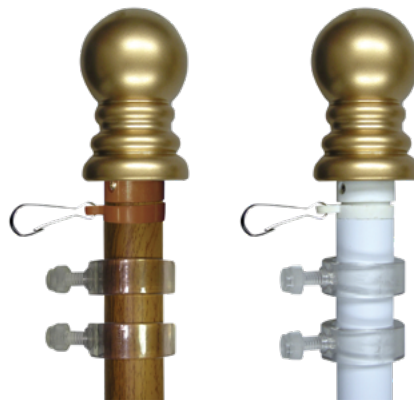

Wood Grain

White



Joint Detail



### WOOD GRAIN BALL ORNAMENT

Can be purchased separately and switched for standard gold or silver ornament.

Item #	Price	Lbs.
324177	\$8.40	.13

## FLAG ETIQUETTE

### HOW TO FLY THE AMERICAN FLAG

The flag should be raised and lowered by hand. Never raise the flag while it is furled; unfurl, then hoist quickly to the peak of the flagstaff. It should be lowered slowly and ceremoniously. The flag should never be allowed to touch anything beneath it, such as the ground or the floor.

The flying of the flag at half-staff is a sign of mourning. When flown at half-staff, the flag should be first hoisted to the peak, then immediately lowered to the half-staff position. It should be raised to the peak again for a moment before it is lowered for the day. "Half-staff" is the point midway between the top and bottom of the flagstaff. On Memorial Day in May, the flag should fly at half-staff from sunrise until noon, and at full-staff from noon until sunset.

At sea services by Navy chaplains, the church pennant may be flown above the flag.

No other flag may be flown above the United States flag except at the United Nations Headquarters. The UN flag may be placed above flags of all member nations. In the UN enclave, national flags of all members are flown with equal prominence.

When the flags of two or more nations are displayed together they should be flown from separate staffs of the same height, and the flags should be of approximately equal size. International usage forbids the display of the flag of one nation above that of another in time of peace.



**1" DIAMETER ALUMINUM DISPLAY POLE SETS**

- Includes 2-piece aluminum pole, gold vinyl ball ornament, 2 flag ties & aluminum lawn socket
- Available in silver mill or bright gold anodized finish

Model	Item #	Length	Color	1-49	50-99	100+	Lbs.
BPA600	320000	6'	Silver	\$46.50	\$42.00	\$41.00	1.0
BPA700	320001	7'	Silver	53.00	46.50	43.50	1.1
BPA800	320002	8'	Silver	56.00	48.00	46.50	1.3
BPA900	320003	9'	Silver	57.00	53.00	48.00	1.6
BPA1000	320004	10'	Silver	63.50	56.00	53.00	1.7
BPA600	320005	6'	Gold	57.00	51.50	48.00	1.0
BPA700	320006	7'	Gold	62.50	57.00	54.50	1.1
BPA800	320007	8'	Gold	71.50	64.50	61.00	1.3
BPA900	320008	9'	Gold	72.50	66.00	64.50	1.6
BPA1000	320009	10'	Gold	76.50	71.50	66.00	1.7



**1" DIAMETER ALUMINUM DISPLAY POLES ONLY**

- Poles only - no other accessories are included
- Available in bright gold anodized or silver mill finish

**Gold**

Item #	Length	Type	Price	Lbs.
320016	3'	Plain	\$19.90	.40
320017	3'	Swedged	20.90	.40
320018	4'	Plain	25.70	.55
320019	4'	Swedged	27.20	.55
320020	5'	Plain	29.80	.65
320021	5'	Swedged	31.70	.65

**Silver**

Item #	Length	Type	Price	Lbs.
320010	3'	Plain	\$12.90	.40
320011	3'	Swedged	14.30	.40
320012	4'	Plain	15.10	.55
320013	4'	Swedged	16.10	.55
320014	5'	Plain	17.50	.65
320015	5'	Swedged	18.60	.65
324184	6'	Plain	26.50	.80

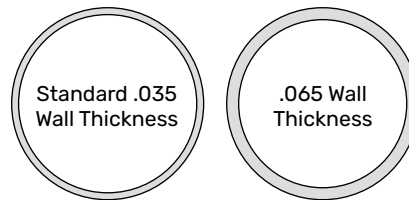

**1" DIAMETER HEAVY WALL ALUMINUM DISPLAY POLES**

These clear anodized aluminum tubing sections feature a wall thickness of almost double the wall thickness of our standard aluminum tubing sections.

Item #	Length	Color	Type	Price	Lbs.
324188	5'	Silver	Plain	\$24.50	1.2
324189	5'	Silver	Swedged	25.20	1.2
324190	6'	Silver	Plain	30.80	1.4

# OUTDOOR FLAGPOLES

RESIDENTIAL FLAGPOLES



## 6' X 1" 5-SECTION STAINLESS STEEL FLAGPOLE

This stainless steel pole comes in five sections, making it compact for easy shipping. The pole has a polished finish, threaded/interlocking sections, and includes a ball ornament and rotating flag attachment rings. Use with brackets that accept a 1" outside diameter pole (not included).

Item #	Size	1-11	12-35	36+	Lbs.
324364	6' x 1"	\$45.50	\$43.00	\$39.50	1.5

## FIBERGLASS 1" DISPLAY POLE SETS

Includes 1-piece fiberglass pole, wood ball ornament, 2 flag ties & aluminum lawn socket.

Item #	Model	Color	Length	Dia.	1-11	12-71	72+	Lbs.
320022	BPFG500	White	5'	1"	\$44.00	\$41.00	\$38.50	1.6
320023	BPFG600	White	6'	1"	46.50	44.00	41.00	1.8
320024	BPFG800	White	8'	1"	59.00	56.00	46.50	2.3

The 10' pole listed below must ship via truck

320025	BPFG1000	White	10'	1"	\$66.00	\$63.50	\$56.00	2.8
--------	----------	-------	-----	----	---------	---------	---------	-----

## FIBERGLASS 1" DISPLAY POLES ONLY

No other accessories are included.

Item #	Model	Color	Length	1-11	12-23	24+	Lbs.
320026	FPO-5	White	5'	\$28.00	\$24.00	\$21.00	1.3
320027	FPO-6	White	6'	29.50	25.00	23.00	1.5
324080	FPO-6	Black	6'	32.00	29.50	24.50	1.5
320028	FPO-8	White	8'	38.50	33.00	29.50	2.0

The 10' pole listed below must ship via truck

320029	FPO-10	White	10'	\$44.00	\$39.50	\$34.00	2.5
--------	--------	-------	-----	---------	---------	---------	-----



## 9' X 1" ROTATING POLE WITH LAWN SOCKET

This white painted aluminum 2-piece pole includes 2 flag fasteners (for flying a grommeted flag), a snap (for flying flags with a pole sleeve and tab), and a galvanized steel lawn socket. The top of the pole rotates on ball bearings so the flag won't tangle.

Item #	Size	1-11	12-35	36+	Lbs.
324178	9' x 1"	\$75.40	\$66.10	\$62.70	3.8



**COLLAPSIBLE FLAGPOLES TO GO**

- Acorn ornament on all aluminum poles
- Ball ornament on 16' fiberglass pole
- All poles are silver including the 16' fiberglass pole. The clip design allows adjustment for a variety of flag sizes from 1' x 2' through 3' x 5'. It also locks the flag into place.

Item #	Model	Type	Extended Length	Closed Length	Bottom Dia.	Top Dia.	1-5	6+	Lbs.
320033	FTG-9	Aluminum	8'-8"	40"	3/4"	1/2"	\$66.00	\$64.00	.66
320035	FTG-15	Aluminum	14'-4"	40"	1"	1/2"	106.00	101.00	1.3
324180	FTG-16F	Fiberglass	16'-0"	51"	1-5/8"	3/4"	145.00	140.00	2.7
320037	FTG-21	Aluminum	20'-0"	48"	1-1/4"	1/2"	134.00	131.00	2.1



Fiberglass



Aluminum



**TAILGATE STANDS FOR FLAGPOLES TO GO**

Two-piece design collapses to 2" tall for easy storage. Lightweight aluminum with an enamel coating to prevent oxidizing. Set screw locks pole into place and can hold all sizes of our collapsible poles.

Item #	1-5	6+	Lbs.
323515	\$119.00	\$111.00	3.0



FLAG ETIQUETTE

**HOW TO RESPECT AND DISPLAY OUR NATIONAL FLAG**

**HOW TO FLY THE FLAG**  
The flag should be raised and lowered by hand. Never raise the flag while it is folded; unfold it first, then hoist quickly to the peak of the flagstaff. It should be lowered slowly and ceremoniously. The flag should never be allowed to touch anything beneath it, such as the ground or the floor.

**WHEN TO DISPLAY THE FLAG**  
The flag should be displayed on all days when the weather permits, especially on legal holidays or other special occasions. It is customary to display the flag from sunrise to sunset on buildings and on stationary flagpoles in the open. However, on special occasions it may be displayed at night, preferably lighted. In several places the flag flies day and night, among these are the Capitol in Washington, D.C., and the Fort McHenry National Monument in Baltimore, which was the inspiration for "The Star Spangled Banner" by Francis Scott Key.

**FLAG ETIQUETTE BROCHURE**

This fully illustrated brochure contains all of the etiquette printed on this page plus a "FLAG HOLIDAYS" and "CARING FOR YOUR FLAG" section. Measures 8" x 5-1/4".

Model	Item #	1-49	50+	Lbs.
ETQ-B	420000	\$1.48	\$1.38	.02

**FLAG ETIQUETTE BOOKLET**

An abbreviated version of our Flag Etiquette Brochure which measures 3-1/2" x 2-3/4" is also available.

Model	Item #	1-99	100+	Lbs.
ETQ-S	420001	\$0.38	\$0.32	.001

# OUTDOOR FLAGPOLES

## LAWN-MATE FLAGPOLE

12' all-aluminum ground set flagpole that consists of two 1-3/8" diameter silver anodized, seamless aluminum tubing sections which swedge into each other providing a smooth exterior finish.

### STANDARD FITTINGS INCLUDE:

- 2-1/2" gold vinyl ball ornament
- Nylon flag ties for securing flag to pole
- Heavy-duty cast aluminum lawn socket with cap
- Can be shipped via parcel carrier

### Complete Set

Item #	Finish	# of Sections	1-11	12+	Lbs.
320038	Silver	2	\$134.00	\$128.00	4.1

### 1-3/8" Diameter Sections Only

Item #	Finish	Length	Description	Price	Lbs.
320039	Silver	6'	Plain	\$46.50	1.4
320040	Silver	6'	Swedged	48.00	1.4



## TELESCOPING FLAGPOLES

Aluminum flagpoles available in exposed heights of 15', 20' & 25'

Note: All exposed heights include the ball ornament and are approximate.

### FEATURES

- **Rope & pulley free:** no tangles or knots
- **Noise free:** no clanging ropes
- **Maintenance free:** no painting, no rust
- **Sturdy & durable:** 16 gauge aluminum

### STANDARD ACCESSORIES

- **Polycarbonate swivel rings:** includes a double flag harness for flying two flags
- **Clear polycarbonate pin lock collar:** fits around lowest pole button to prevent unauthorized raising or lowering of the flagpole (collar can be secured with a nut and bolt or a small lock, not included)
- **3" gold anodized aluminum ball:** with 15' and 20' poles (25' pole not supplied with ball ornament, however, we suggest a 4" diameter ball which can be ordered separately.)
- **Heavy duty PVC foundation sleeve**

Model	Exp. Ht.	Butt Dia.	Top Dia.	Lbs.	Clear Anodized			Bronze Anodized				Black Anodized				
					Item #	1-2	3-6	7+	Item #	1-2	3-6	7+	Item #	1-2	3-6	7+
T16	15'	2-1/4"	1-3/4"	12	320083	\$548	\$530	\$510	320085	\$713	\$693	\$674	320087	\$641	\$622	\$603
T20	20'	2-1/2"	1-3/4"	17	320084	668	647	630	320086	748	729	693	320088	748	729	693
T25	25'	3"	1-3/4"	28	323446	960	890	880	-	-	-	-	-	-	-	-



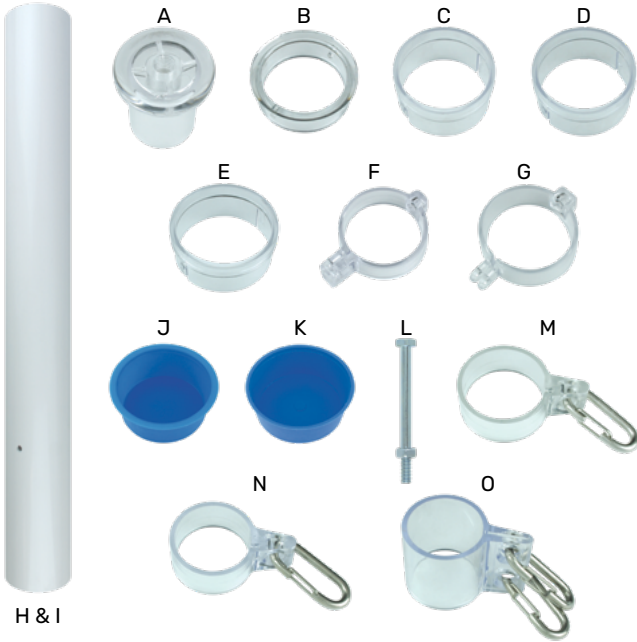

**TELESCOPING FLAGPOLE REPLACEMENT PARTS**

\* Sleeve cap & sleeve pin bolt are supplied with foundation sleeve.

Item #	Description	For Pole Size	Price	Lbs.
A 320096	Top Ornament Fitting	15', 20'	\$16.30	.10
B 320097	Top Stop Ring	15', 20'	9.60	.05
C 320098	Small Bushing	15', 20'	9.60	.05
D 320099	Medium Bushing	15', 20'	9.60	.05
E 320100	Large Bushing	20'	9.60	.05
F 320101	Pin Lock	15'	22.90	.05
G 320102	Pin Lock	20'	22.90	.05
H 320105	Foundation Sleeve*	15'	38.10	1.4
I 320106	Foundation Sleeve*	20'	38.10	1.4
J 320107	Foundation Sleeve Cap	15'	4.80	.02
K 320108	Foundation Sleeve Cap	20'	4.80	.02
L 320109	Foundation Sleeve Pin Bolt	15', 20'	8.94	.10
M 320110	Top Flag Harness	15', 20'	18.50	.15
N 320111	Bottom Flag Harness	15', 20'	25.70	.15
O 320112	Double Flag Harness	15', 20'	29.20	.20

**STAINLESS STEEL SLEEVE CLAMP**

Prevents lifting pole out of ground sleeve

Item #	Description	Price	Lbs.
320091	For 15' Pole	\$61.00	.30
320092	For 20' Pole	61.00	.30



**ALUMINUM TRAILER HITCH MOUNT**

For standard 2" square reese receiver hitches

\* Additional insert required for T16 (15') pole. Please specify when ordering.

Item #	Description	Price	Lbs.
323445	For 15'* & 20' Poles	\$223.00	5.2



**ALUMINUM WHEEL MOUNT**

\* Additional insert required for T16 (15') pole. Please specify when ordering.

Item #	Description	Price	Lbs.
320093	For 15'* & 20' Poles	\$272.00	12



**ALUMINUM DOCK MOUNT**

\* Additional insert required for T16 (15') pole. Please specify when ordering.

Item #	Description	Price	Lbs.
320094	For 15'* & 20' Poles	\$211.00	4.7

**ALUMINUM SIDE MOUNT**

Mounts to any flat or round surface

\* Additional insert required for T16 (15') pole. Please specify when ordering.

Item #	Description	Price	Lbs.
320095	For 15'* & 20' Poles	\$263.00	3.3



# OUTDOOR FLAGPOLES

RESIDENTIAL FLAGPOLES



## FLY IT FLAGPOLE SET WITH FLAG

Flagpole consists of powder coated white painted seamless aluminum tubing sections which swedge together providing a smooth exterior finish.



### STANDARD FITTINGS INCLUDE:

- Eyebolt & pulley assembly for easy raising & lowering of flag
- Solid braided halyard
- 2 nylon flag snaps
- Cast nylon rope cleat with mounting screws
- Gold vinyl ball ornament
- PVC foundation sleeve
- Can be shipped via parcel carrier
- 3' x 5' fully printed poly-cotton outdoor flag

Item #	Overall Length	Butt/Top Diameter	# of Sections	1-11	12-23	24+	Lbs.
324363	18'	1-5/8"	4	\$104.00	\$98.00	\$92.00	7.2

## FLY IT - POLE SECTIONS ONLY

Item #	Length	Dia.	Finish	Description	Price	Lbs.
320047	54"	1-5/8"	White	Swedged - No Drilling	\$36.50	1.3
320048	54"	1-5/8"	White	Swedged - Drilled For Cleat	39.00	1.3
323984	54"	1-5/8"	White	Swedged - Drilled For Pulley	40.00	1.3

## WHITE TITAN FLAGPOLE SETS

These flagpoles offer exceptional quality at a budget price. The flagpole tubing sections are heavy-duty 19 gauge first run quality steel. The entire inside length of the flagpole is galvanized to prevent rusting while the outside is beautifully finished with a white powder coating. The tubing sections swedge together perfectly to provide a smooth exterior finish.

**STANDARD FITTINGS INCLUDE:**

- Gold vinyl ball ornament
- Pulley assembly
- Solid braided polypropylene halyard
- 2 nylon flag snaps
- Nylon rope cleat with mounting screws
- PVC foundation sleeve
- Easy-to-follow installation instructions
- Can be shipped via parcel carrier

Item #	Model	Exposed Height	Butt/Top Diameter	# of Sections	1-11	12-23	24+	Lbs.
323430	WT12	12'	1-3/8"	3	\$150.00	\$143.00	\$136.00	9.1
323431	WT18	18'	1-5/8"	4	185.00	170.00	167.00	14.9
323432	WT22	22'	1-3/4"	5	284.00	265.00	247.00	21.4

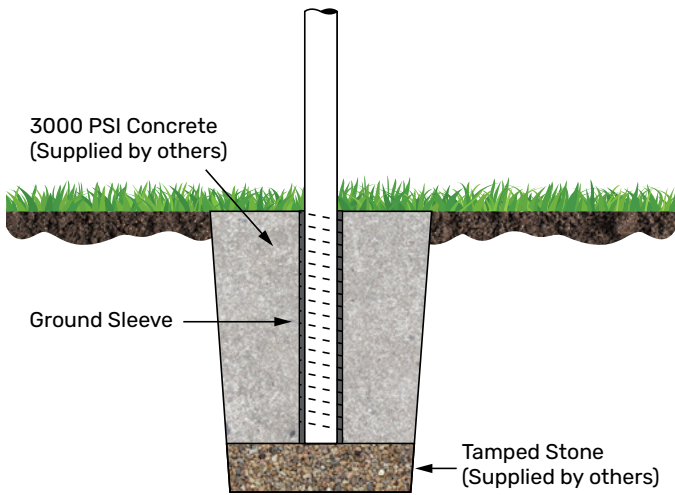

Tubing sections swedge together perfectly providing a smooth exterior finish.



The 12' pole is very popular with tailgaters! See [page 104](#) for Tire Mount pricing.

# OUTDOOR FLAGPOLES

## HOMESTEADER FLAGPOLE SETS (NO FLAG)

All-aluminum ground set flagpoles available in 10', 15', 20', & 25' exposed heights. The silver anodized, seamless aluminum tubing sections swedge together providing a smooth exterior finish.

### STANDARD FITTINGS INCLUDE:

- Gold anodized aluminum ball ornament  
3" diameter on HS10, HS15 & HS20  
4" diameter on HS25 & HS20HD
- Cast aluminum truck with pulley
- Solid braided polyester halyard
- 2 nylon flag snaps
- Rope cleat with mounting screws  
Nylon cleat on HS10, HS15 & HS20  
Cast aluminum cleat on HS20HD & HS25
- Decorative display/storage box
- Heavy-duty ground sleeve
- Can be shipped via parcel carrier

Item #	Model	Exposed Height	Butt/Top Diameter	# of Sections					Lbs.
					1-5	6-11	12-23	24+	
320053	HS10	10'	2"	2	\$212.00	\$209.00	\$205.00	\$197.00	7.7
320054	HS15	15'	2"	3	237.00	232.00	229.00	219.00	9.8
320055	HS20	20'	2"	4	278.00	271.00	268.00	259.00	11.6
460080	HS20HD	20'	2-1/2"	5	403.00	400.00	395.00	391.00	21.1
320056	HS25	25'	2-1/2"	6	525.00	513.00	501.00	482.00	24.3

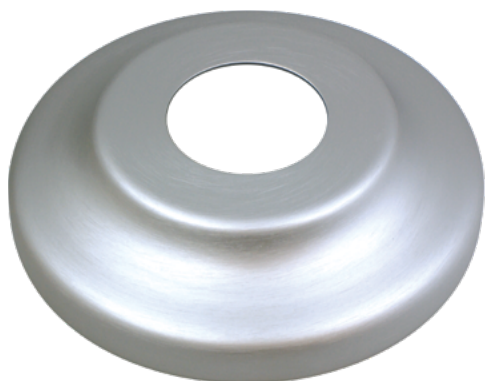
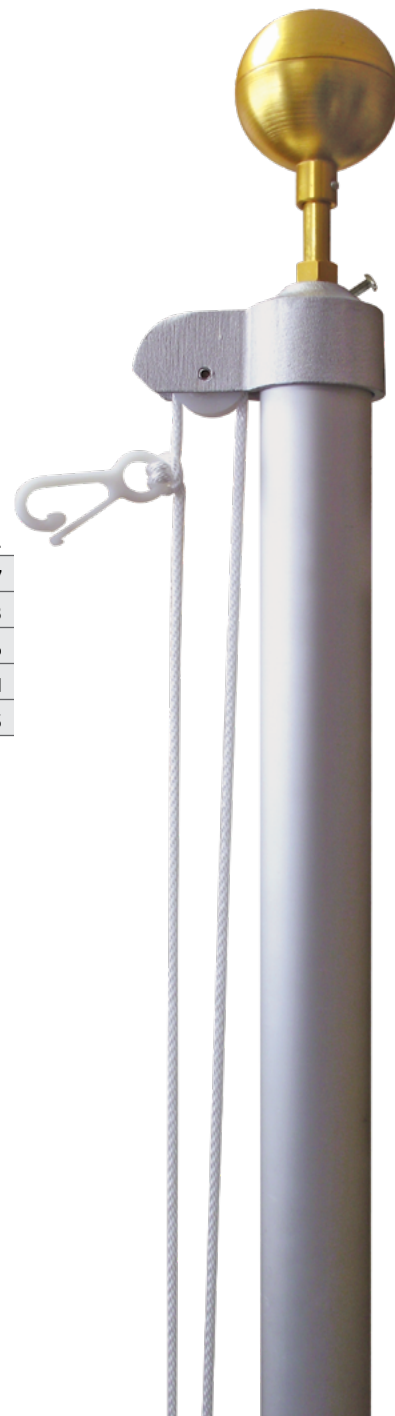

## HOMESTEADER FLASH COLLARS

- 8" Outside diameter
- 2-1/4" High with clear anodized finish

Item #	For Model #	1-5	6+	Lbs.
320064	HS10, HS15, HS20	\$51.50	\$47.50	.40
320065	HS20HD, HS25	51.50	47.50	.35

## HOMESTEADER

Pole sections only

Item #	For Pole Model(S)	Length	Dia.	Finish	Description	Price	Lbs.
320057	HS15, HS20	70"	2"	Silver	Plain - No Drilling	\$53.00	2.0
320058	HS10	70"	2"	Silver	Plain - Drilled For Cleat	52.00	2.0
320059	HS10, HS15, HS20	70"	2"	Silver	Swedged - No Drilling	55.00	2.0
320060	HS15, HS20	70"	2"	Silver	Swedged - Drilled For Cleat	54.50	2.0
320061	HS20HD, HS25	59"	2-1/2"	Silver	Plain - No Drilling	64.50	3.0
320062	HS20HD, HS25	59"	2-1/2"	Silver	Swedged - No Drilling	67.00	3.0
320063	HS20HD, HS25	59"	2-1/2"	Silver	Swedged - Drilled For Cleat	71.00	3.0

## 20' TAPERED HOMESTEADER FLAGPOLE

With a Butt Diameter of 3" Tapering to a Top Diameter of 2"

All-aluminum ground set flagpole available in 20' exposed height. The silver anodized, seamless aluminum tubing sections swedge together providing a smooth exterior finish.

**STANDARD FITTINGS INCLUDE:**

- Nylon rope cleat with mounting screws
- Heavy-duty ground sleeve
- Kraft shipper/storage box can be shipped via parcel carrier
- 3" gold anodized aluminum ball ornament
- Cast aluminum truck with pulley
- Polyester halyard with 2 nylon flag snaps
- **Unique swedge and flared-cup design provides a smooth tapering appearance.**

**Complete Set With Silver Anodized Finish**

Item #	Model	Exposed Height	# of Sections	1-2	3-6	7-12	13-49	50+	Lbs.
320077	TH20	20'	5	\$543.00	\$525.00	\$510.00	\$494.00	\$446.00	19

**Silver Anodized Sections Only**

Item #	Model	Dia.	Length	Description	Price	Lbs.
320078	THS-1	3"	56"	Bottom Section	\$82.00	2.4
320079	THS-2	3"	56"	2nd From Bottom - Drilled For Cleat	84.00	2.4
320080	THS-3	2-5/8"	56"	3rd From Bottom Section	79.00	2.2
320081	THS-4	2-1/4"	56"	4th From Bottom Section	77.00	1.8
320082	THS-5	2"	56"	Top Section	66.00	1.7

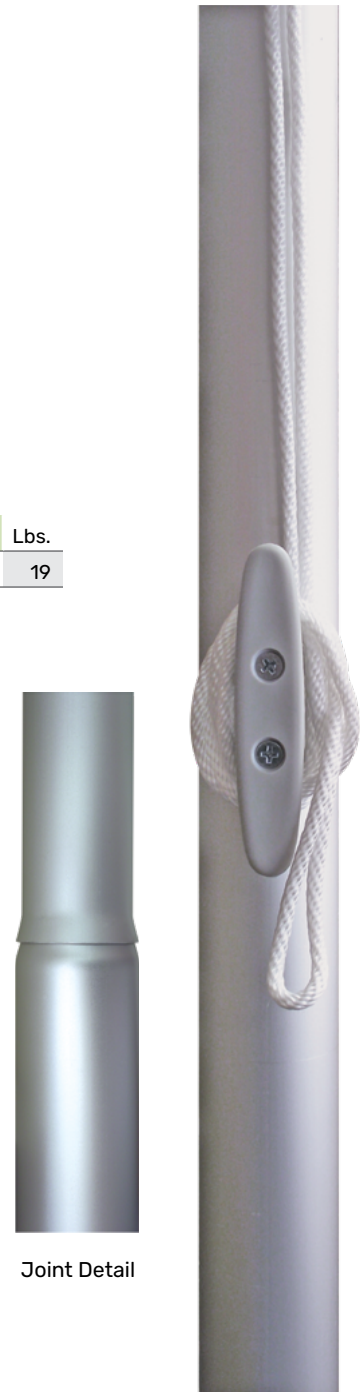

Joint Detail



30° Bracket

## 10' HOMESTEADER OUTRIGGER FLAGPOLES

Standard accessories include 3" gold anodized aluminum ball ornament, cast aluminum truck with pulley, 30' polypropylene halyard with 2 nylon flag snaps, cast nylon cleat with mounting screws and 30° or 45° mounting bracket (mounting hardware not included). All sets come with two 2" diameter sections and can be shipped via parcel carrier.

**Complete Set With Silver Anodized Finish**

Item #	Model	Description	1-5	6+	Lbs.
320071	HS010-30	w/30° Bracket	\$350.00	\$341.00	12

**Mounting Brackets Only**

Item #	Angle	Finish	1-5	6+	Lbs.
320073	30°	Silver	\$143.00	\$137.00	3.4



## INVENTORY

Eder Flag takes pride in maintaining the most extensive inventory of flagpole shafts, accessories, and flags in the USA. We offer commercial-grade cone tapered shafts ranging from 15' to 80' in exposed height. Our flagpoles ship from our headquarters in Wisconsin and our distribution center in Florida.

## MANUFACTURING

Quality is paramount when it comes to shaft fabrication. Our shafts are manufactured and precisely fabricated from new, seamless 6063-T6 aluminum tubing in the USA. On-site welding and fabrication services ensure superior workmanship and design on flagpoles and parts.



Eder Flag is a proud National Association of Architectural Metal Manufacturers member.



At Eder Flag, we stand proudly behind the superior quality of our materials and craftsmanship. That's why every tapered aluminum flagpole shaft we manufacture is backed by a lifetime warranty—a testament to our unwavering commitment to excellence and durability.

Want the full details? Explore our warranty documentation below and see exactly how we stand by our promise.

### LIFETIME WARRANTY

Eder Flag Manufacturing Co., Inc. ("Eder Flag") Lifetime Aluminum Cone Tapered Commercial Flagpole Shaft Warranty (this "Warranty")

Eder Flag warrants for their intended use lifetime that the aluminum tapered flagpole shafts it manufactures will be free of defects in workmanship and material at the time of shipment. [When materials furnished on this job are used for the purpose intended, Eder Flag hereby warrants the cone-tapered aluminum flagpole shaft(s) shipped after May 1, 2017.]

This Warranty extends to the original purchaser only and covers the aluminum cone tapered flagpole shaft only and does not include any accessories or connecting hardware (including, without limitation, anchor bolts and foundations). This Warranty and the rights hereunder may not be assigned, transferred, or otherwise conveyed by the original purchaser. The accompanying hardware (except for snaps, rope, ornaments or cable) is warranted for one (1) year from date of purchase.

Items damaged by improper installation and/or grounding, overloading with incorrect flag size, winds exceeding flagpole wind rating (flagged), accident, vandalism, vehicular impact, transportation/shipping or neglect or negligence by any person are not covered by this Warranty. This Warranty does not include failures caused by the following on-site conditions: wind-induced vibrations and corrosive soils with low (under 5) pH values (Alkaline) or high (over 9) pH values (Acidic).

This Warranty will be void effective immediately in all respects if any alterations, modifications, or additions are made to our product unless Eder Flag approves such alterations, modifications, or additions in writing in advance. This Warranty does not apply to, and Eder Flag shall not be liable or responsible for labor, dismantling, transportation, re-erection, shipping, removal, re-installation, taxes, or other similar incidental costs. In no event shall Eder Flag be liable for any loss of use, revenue, or profit, or consequential, indirect, special, exemplary, punitive, back charges, or liquidated damages, whether arising out of breach of contract, tort (including negligence) or otherwise, regardless of whether such damages were foreseeable and whether or not Eder Flag has been advised of the possibility of such damages, and notwithstanding the failure of any agreed or other remedy of its essential purpose. In no event shall Eder Flag's aggregate liability arising out of or related to this Warranty, whether arising out of or related to breach of contract, tort (including negligence) or otherwise exceed the cost of a replacement flagpole.

Material that needs to be returned will require a written authorization form from Eder Flag, including correct shipping instructions. Material returned without a return authorization will not be accepted.

This Warranty excludes any finishes, such as powder coating and anodizing processes.

Eder Flag will, at its sole discretion, repair, replace, or credit the original purchaser's account for any product that does not conform to this Warranty, and such repair, replacement, or credit shall be such purchaser's sole and exclusive remedy under this Warranty and otherwise. Except for the warranties expressly set forth in this lifetime warranty, Eder Flag makes no other warranties, express or implied, whatsoever with respect to aluminum tapered flagpole shafts, and all other warranties are hereby expressly disclaimed, including, without limitation, any warranty of merchantability, any warranty of fitness for a particular purpose and any warranty against infringement of intellectual property, whether express or implied by law, course of dealing, course of performance, usage of trade or otherwise. The purchaser acknowledges that this disclaimer is conspicuous.

31329579.2

### RECEIVING AND STORAGE INSTRUCTIONS

Flagpole shafts can stain if they are allowed to remain in contact with wet or damp wrapping material. If there is any sign of exposure to moisture, remove the shaft from the tube and unwrap it immediately to allow it to dry. If the flagpole is to be stored outdoors, the paper wrapping must be removed, and the flagpole must be stored off the ground.

## EXCLUSIVE EDER FLAG M-WINCH SUCCESSFULLY USED IN THE FIELD FOR OVER 40 YEARS

For over 40 years, the exclusive Eder Flag M-Winch has been successfully used in the field. It is a gearless and self-locking winch that requires no maintenance or monthly lubrication. It eliminates the need for a separate brake and smoothly raises and lowers the flag with minimal effort. The M-Winch does not require welding, and the flush mount design gives it a clean appearance. The cylinder lock and key and the Eder Flag M-Winch handle provide additional flag security.

See page 161 for M-Winch pricing.

### FEATURES

- Maintenance-free – no lubrication needed
- Sleek design
- Secure – requires a key and specialized handle to lower flag
- Quick raising and lowering of flag
- Absence of separate braking system minimizes chance of slippage
- Available in flagpole models ranging from 20'-80'



This is the appearance of the M-Winch in the locked position.



To remove the lock, insert the key, turn counter-clockwise, and remove the lock, exposing the M-Winch insertion slot.



Insert the handle into the M-Winch insertion slot, apply inward pressure to the locking mechanism, and raise or lower the flag to the desired position.

### M-WINCH HANDLES

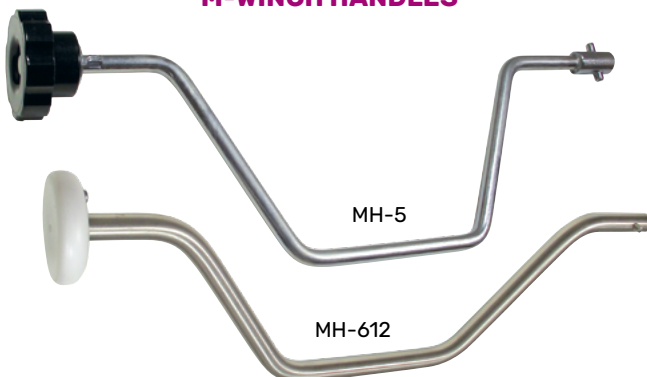

### LOCKS & KEYS FOR M-WINCHES



**GUIDELINES FOR SELECTING THE RIGHT FLAGPOLE HEIGHT AND FLAG SIZE FOR YOUR DISPLAY**

When selecting the height of your flagpole and the size of your flag, you must consider the location where you will display the flag and the surrounding environment. Flying flags larger than the recommended flag size increases the stress load on the flagpole which could potentially void the shaft warranty. If you plan to fly multiple flags on the same pole, ensure that the total square footage of all the flags does not exceed the square footage of the recommended flag size. Review any local ordinances or regulations to verify no flagpole height restrictions.

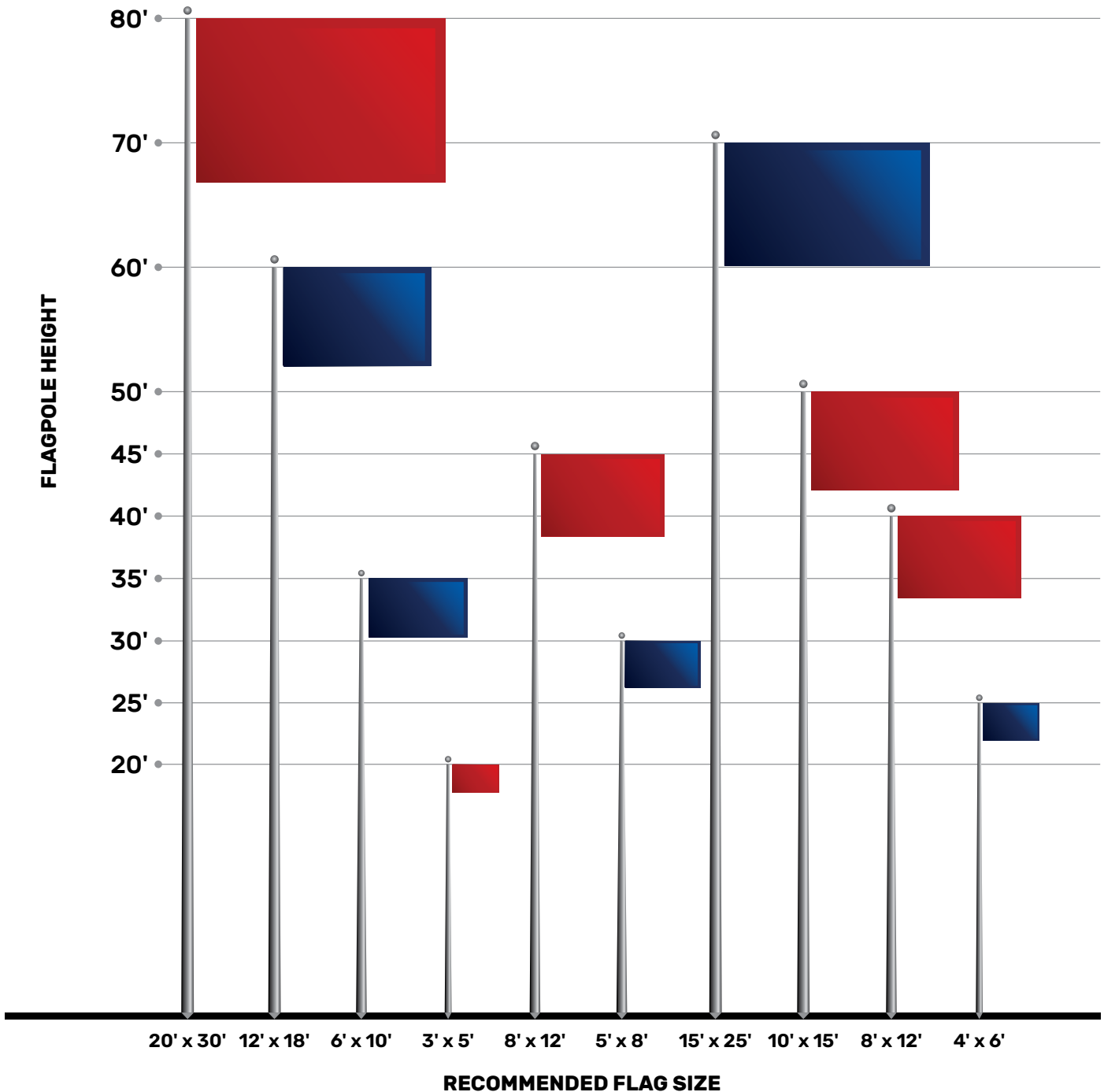

# OUTDOOR FLAGPOLES

## EXTERNAL HALYARD

Available with Architectural, Hurricane, Economy Extra, Atlas, and Special Budget Series Flagpoles

### FEATURES INCLUDE:

- Traditional appearance
- Easy to maintain
- Options for security
- Manual operation
- Option for double cleat and halyard for backup



## INTERNAL HALYARD WITH CAM CLEAT SYSTEM

Available with Vanguard Series Flagpoles

### FEATURES INCLUDE:

- Economical choice for an internal halyard system
- Locking door for security
- Easy to maintain
- Polyester wire centered halyard inside the flagpole

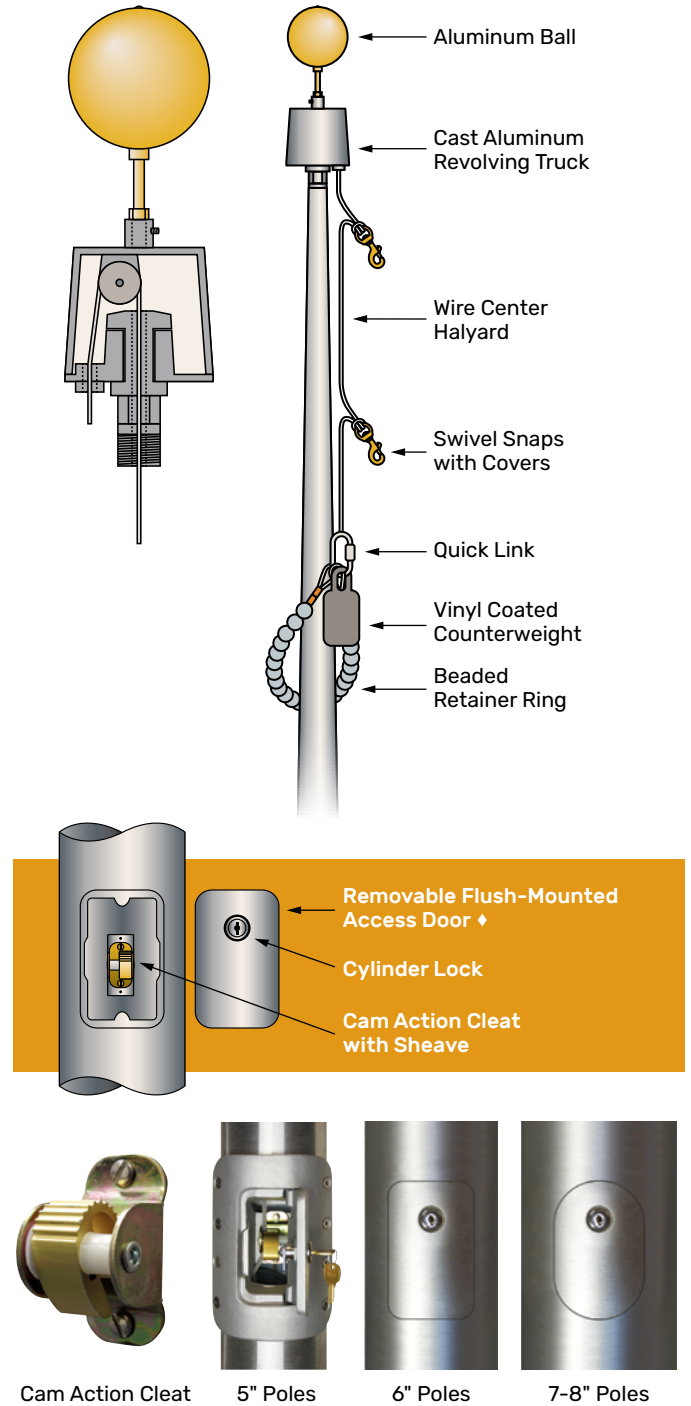

♦ 5" diameter poles supplied with a hinged access door and frame unit. 6" and larger diameter poles supplied with a removable flush-mounted access door which is internally framed for added strength.

## INTERNAL HALYARD WITH M-WINCH

Available with Deluxe IH and Hurricane Deluxe IH Series Flagpoles

These internal halyard flagpoles come with the M-Winch mounted inside the flagpole shaft, operable only with a removable crank handle.

### FEATURES INCLUDE:

- Clean appearance
- Easy to raise & lower flag with M-Winch handle
- Low maintenance – no winch lubrication needed
- Security supplied with cylinder lock and key

## M-WINCH

### FEATURES INCLUDE:

- Maintenance-free – no lubrication needed
- Sleek design
- Secure – requires a key and specialized handle to lower flag
- Quick raising and lowering of flag
- Absence of separate braking system minimizes chance of slippage
- Available in flagpole models ranging from 20'-80'

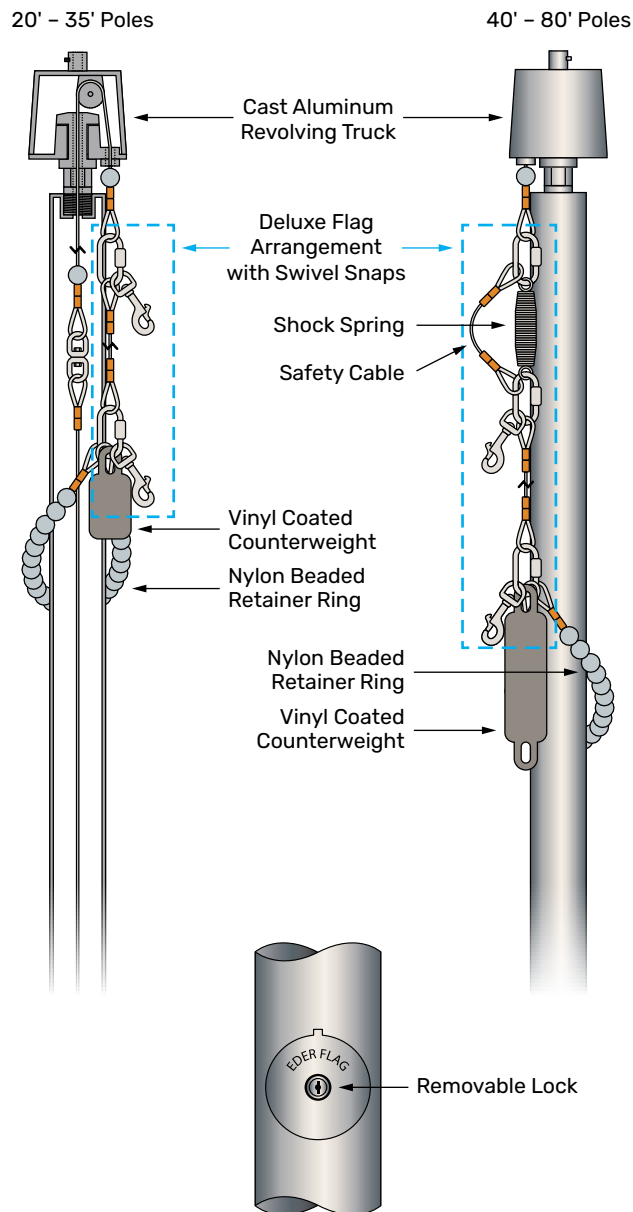

**M-WINCH DETAIL**  
No welding is required.  
No monthly lubrication is needed.

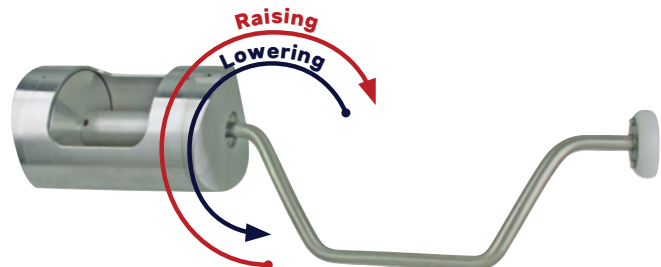
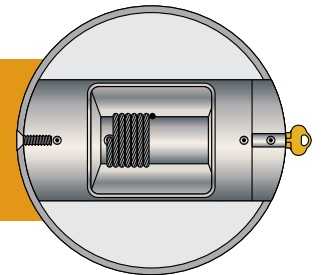

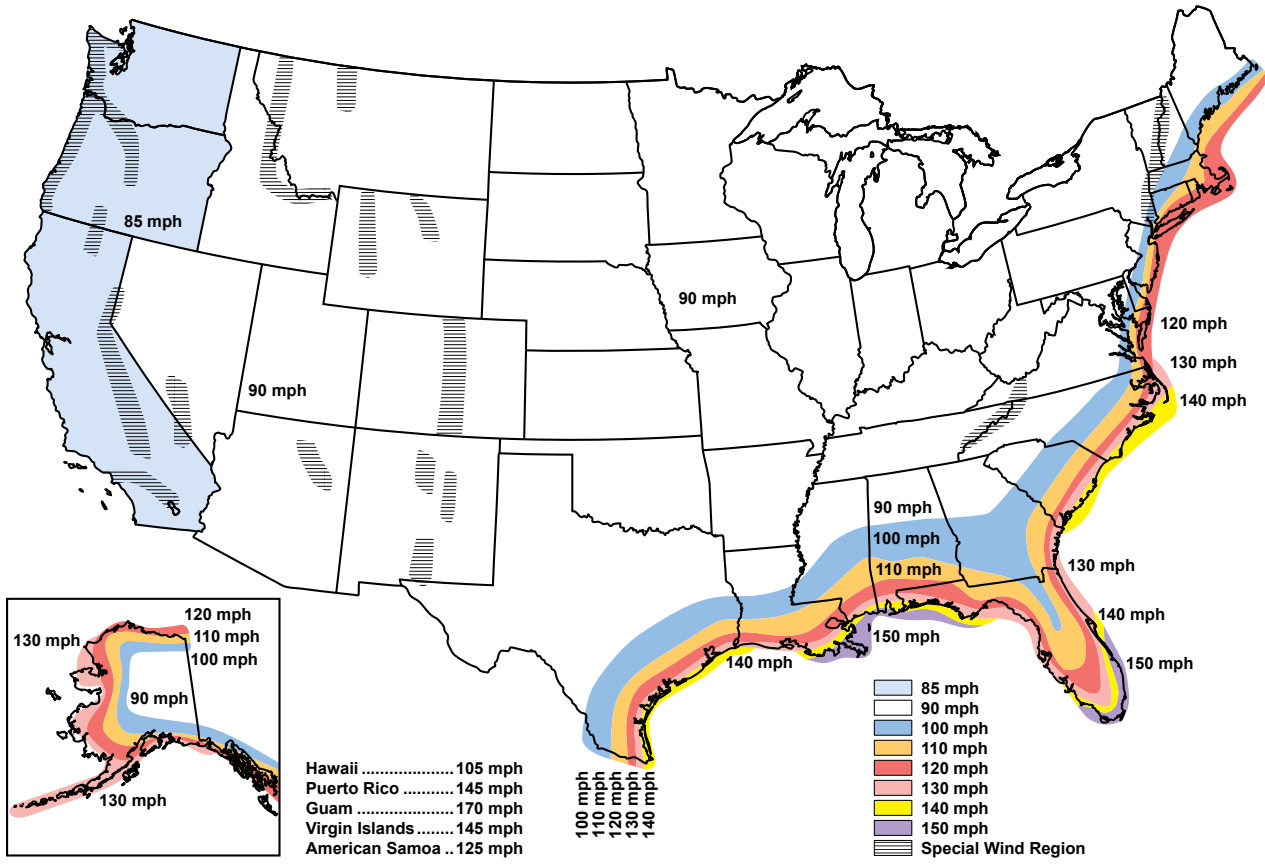

## GROUND SET CONE TAPERED ALUMINUM FLAGPOLES WIND LOAD CHART

The map above shows the maximum steady wind expected at an elevation of thirty feet above ground level within a fifty-year period of recurrence. Areas with the same maximum constant or steady wind speed are indicated.

Because wind speeds are usually not constant, and gusts are involved, flagpoles (both flagged and unflagged) are listed in this catalog with a constant wind speed and a 1.3 gust factor.

Flagpoles and their associated wind speeds listed assume that ten percent of the overall length of the flagpole is buried at or near ground level per industry recommendations. Special engineering may be required for other applications such as wall or roof mounted flagpoles. Contact us for a prompt response regarding any situation that may require special engineering.

**Safe flagpole design requires knowledge of the loads to which they will be subjected.** Principal load acting on flagpoles is wind load and that load must be carefully determined. Maximum wind speeds to which flagpoles are exposed are dependent upon many factors such as geographical location, whether or not it is in the center of a large city, a small town's outskirts, seashore, at ground level or on the roof of a high building. Wind speeds generally are higher along coastal areas than inland. They are also higher in open country than in the center of cities. Wind speed also becomes greater as height above ground increases. Wind exerts a force on the pole as well as the flag, thus both loads must be added to determine total load. Flags of different sizes are designed to be flown from different poles.

**It's important that flagpoles be selected which are capable of supporting the largest flag intended to be flown in the highest wind speed to which it will be subjected.** Loads on flagpoles are resisted by the mounting foundation, roof, or wall to which it is secured.

- Specified wind speed calculations are based on nylon flag material and use of suggested flag size.
- All flagpole design calculations are in accordance with GUIDE SPECIFICATIONS FOR DESIGN LOADS OF METAL FLAGPOLES, ASNI/NAAMM FL 1001-07 Fifth Ed.

PLEASE NOTE: recommended flag sizes throughout this catalog do not represent a guarantee that the flag size shown may be safely flown in all wind speeds. When flying oversized flags or flags above the maximum wind rating, personal injury, flagpole damage or property damage can occur.

Signed and sealed engineering documentation is available upon request. In house NAAMM based loading calculations are available upon request at no charge. Signed and sealed engineering documents available for all states at a fee.

See [page 117](#) for receiving and storage instructions.

## OUTDOOR FLAGPOLES

Eder Flag Manufacturing cone tapered aluminum flagpoles are precision fabricated from seamless 6063-T6 alloy tubing, utilizing the industry's most sophisticated manufacturing processes. All aluminum flagpole shafts are polished with fine-grain aluminum oxide cloth resulting in a high-quality finish.

### SATIN FINISH

Satin finish is the most common and most specified finish in the flagpole industry. This is a brushed finish created during the polishing process, resulting in a smooth and consistent appearance. Its elegant, soft sheen is low-maintenance and is highly resistant to corrosion.

### STANDARD ANODIZED FINISHES

Standard anodized finishes are Clear, Dark Bronze (#313) and Black.

Anodizing is an electrochemical process that results in a colored aluminum oxide layer on the aluminum surface. This finish allows for greater durability, increased protection from the elements, and enhanced corrosion resistance, making it ideal for coastal environments. Because the finish is fully integrated with the aluminum itself, it will not flake or peel.

**PLEASE NOTE:** Due to the inherent nature of the anodizing process, Eder Flag does not warrant anodized finishes with regards to consistency and color uniformity. Color variation will inherently occur between tube, casting, and weld alloys. Castings and welds require varying levels of localized touch up painting to help approximate the color of the anodized product. Differences in the surface properties of the shaft caused by cold working fabrication processes such as tapering can result in color variations of the anodized finish. The anodizing process may also increase the potential visibility of die lines.



A custom color powder coated finish is also available. We offer white, black, gray, and custom colors upon request. A powder coat painted finish may be more suitable for a particular project. Please contact us for a prompt quotation.



SATIN

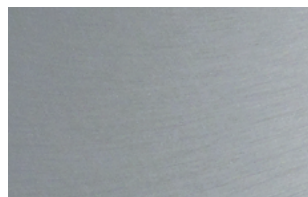

CLEAR

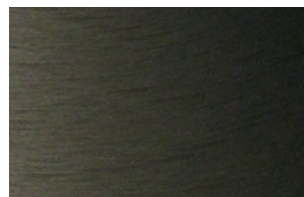

BRONZE #313 (DARK)

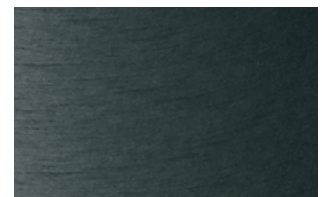

BLACK (#335)

If ordering three or more flagpoles that are different models, please contact a sales representative to inquire about our quantity discount.

## ARCHITECTURAL SERIES

### External Halyard Ground Set Cone Tapered Aluminum Flagpoles

#### STANDARD ACCESSORIES

- Gold anodized aluminum ball ornament
- Cast aluminum revolving truck with pulley
- Solid braided polyester halyard
- Swivel flag snaps with vinyl snap covers
- Cast aluminum cleat with mounting screws
- Spun aluminum flash collar
- Galvanized steel foundation sleeve

**Add \$64.00 to any of the flagpole prices on this page for double-cleat/double-halyard flagpoles.**

\* Flagpole models available in both one and two section styles; please specify when placing your order. Single section pole(s) will be shipped if not specified.

**Add 10% to the pricing for two section style flagpoles.**

\*\* Flagpole models available in multi-piece pole(s) only.

Model	Exposed Height	Overall Length	# of Sections	Butt Dia.	Top Dia.	Wall	Unflagged Max. Wind Speed	Flagged Max. Wind Speed	Suggested Flag Size	Shipping Weight
EC20	20'	23'	1	5"	3"	.188	315 MPH	120+ MPH	3' x 5'	137 lbs.
EC25	25'	27'	1	6"	3-1/2"	.188	250 MPH	120+ MPH	4' x 6'	195 lbs.
EC30	30'	33'	1 or 2*	6"	3-1/2"	.188	211 MPH	120+ MPH	5' x 8'	227 lbs.
EC35	35'	38-1/2'	1 or 2*	7"	3-1/2"	.188	202 MPH	120 MPH	6' x 10'	271 lbs.
EC40	40'	44'	2**	8"	3-1/2"	.188	203 MPH	120 MPH	8' x 12'	311 lbs.
EC45	45'	49-1/2'	2**	8"	3-1/2"	.188	166 MPH	100 MPH	8' x 12'	361 lbs.
EC50	50'	55'	3**	10"	4"	.188	185 MPH	115 MPH	10' x 15'	513 lbs.
EC60	60'	66'	3**	12"	4"	.250	213 MPH	120 MPH	12' x 18'	833 lbs.
EC70	70'	77'	3**	12"	4"	.250	169 MPH	105 MPH	15' x 25'	978 lbs.
EC80	80'	88'	3**	12"	4"	.375	174 MPH	105 MPH	20' x 30'	1357 lbs.

#### SATIN

Model	Item #	1-2	3-6	7+
EC20	320113	\$2,680	\$2,540	\$2,430
EC25	320114	3,400	3,300	3,080
EC30	320115	3,940	3,810	3,530
EC35	320116	5,100	4,790	4,560
EC40	320117	6,540	6,320	6,010
EC45	320118	7,390	7,030	6,680
EC50	320119	10,010	9,540	9,070
EC60	320120	19,430	18,450	17,510
EC70	320121	21,880	20,820	19,700
EC80	320122	27,680	26,510	25,140

#### CLEAR ANODIZED

Model	Item #	1-2	3-6	7+
EC20	320123	\$3,260	\$3,120	\$2,920
EC25	320124	4,160	3,920	3,750
EC30	320125	4,810	4,590	4,310
EC35	320126	6,160	5,910	5,540
EC40	320127	8,010	7,590	7,180
EC45	320128	8,870	8,430	7,950
EC50	320129	12,420	11,820	11,160
EC60	320130	22,310	21,190	20,070
EC70	320131	25,180	23,930	22,660
EC80	320132	32,350	30,690	29,140

#### BRONZE ANODIZED

Model	Item #	1-2	3-6	7+
EC20	320133	\$3,340	\$3,210	\$3,020
EC25	320134	4,210	4,050	3,800
EC30	320135	4,920	4,670	4,440
EC35	320136	6,340	6,000	5,670
EC40	320137	8,220	7,830	7,410
EC45	320138	9,150	8,660	8,220
EC50	320139	12,790	12,200	11,520
EC60	320140	22,840	21,690	20,540
EC70	320141	25,820	24,470	23,170
EC80	320142	32,980	31,360	29,590

#### BLACK ANODIZED

Model	Item #	1-2	3-6	7+
EC20	320143	\$3,520	\$3,320	\$3,110
EC25	320144	4,480	4,280	4,040
EC30	320145	5,240	4,990	4,690
EC35	320146	6,640	6,290	5,950
EC40	320147	8,660	8,220	7,800
EC45	320148	9,650	9,160	8,660
EC50	320149	13,510	12,780	12,160
EC60	320150	23,680	22,470	21,260
EC70	320151	26,810	25,400	24,090
EC80	320152	34,160	32,500	30,710

#### STANDARD FLAGPOLE CONFIGURATION

1. Aluminum ball
2. Cast aluminum revolving truck
3. One halyard
4. Swivel snaps with covers
5. Cast aluminum cleat
6. 3000 PSI concrete (supplied by others)
7. Foundation sleeve
8. Dry tamped sand (supplied by others)
9. Steel base plate
10. Support plate
11. Grounding spike
12. Aluminum flash collar
13. Hardwood wedges (supplied by others)

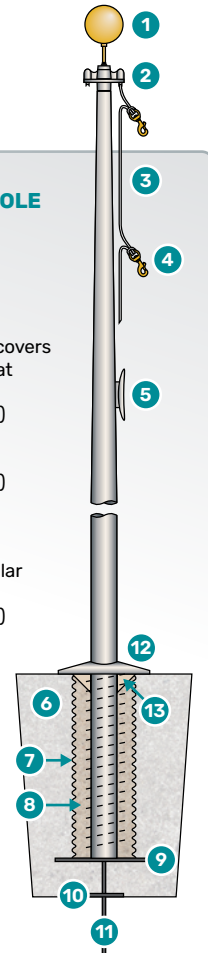

## HURRICANE SERIES

External Halyard Ground Set Cone Tapered Aluminum Flagpoles

### STANDARD ACCESSORIES

- Gold anodized aluminum ball ornament
- Cast aluminum revolving truck with pulley
- Solid braided polyester halyard
- Swivel flag snaps with vinyl snap covers
- Cast aluminum cleat with mounting screws
- Spun aluminum flash collar
- Galvanized steel foundation sleeve

Add \$64.00 to any of the flagpole prices on this page for double-cleat/double-halyard flagpoles.

Model	Exposed Height	Overall Length	# of Sections	Butt Dia.	Top Dia.	Wall	Unflagged Max. Wind Speed	Flagged Max. Wind Speed	Suggested Flag Size	Shipping Weight
ECH25	25'	27'	1	6"	3-1/2"	.250	255 MPH	150+ MPH	4' x 6'	239 lbs.
ECH30	30'	33'	2	6"	3-1/2"	.250	241 MPH	150+ MPH	5' x 8'	322 lbs.
ECH35	35'	38-1/2'	2	8"	3-1/2"	.250	255 MPH	150 MPH	6' x 10'	351 lbs.
ECH40	40'	44'	2	8"	3-1/2"	.250	231 MPH	150 MPH	8' x 12'	399 lbs.
ECH50	50'	55'	3	10"	4"	.312	230 MPH	150 MPH	10' x 15'	661 lbs.

Increased wall thickness and/or butt diameter make our Hurricane Series flagpoles the best choice for high wind locations.

### SATIN

Model	Item #	1-2	3-6	7+
ECH25	324117	\$4,570	\$4,360	\$4,190
ECH30	324118	6,250	6,010	5,720
ECH35	324119	7,010	6,680	6,430
ECH40	324120	8,110	7,760	7,450
ECH50	324121	15,210	14,630	14,040

### CLEAR ANODIZED

Model	Item #	1-2	3-6	7+
ECH25	324122	\$5,240	\$5,030	\$4,720
ECH30	324123	7,180	6,840	6,600
ECH35	324124	8,210	7,830	7,540
ECH40	324125	9,580	9,200	8,860
ECH50	324126	17,430	16,740	16,040

### BRONZE ANODIZED

Model	Item #	1-2	3-6	7+
ECH25	324127	\$5,450	\$5,240	\$5,030
ECH30	324128	7,320	7,010	6,760
ECH35	324129	8,550	8,220	7,840
ECH40	324130	9,900	9,510	9,150
ECH50	324131	18,020	17,330	16,610

### BLACK ANODIZED

Model	Item #	1-2	3-6	7+
ECH25	324132	\$5,710	\$5,510	\$5,280
ECH30	324133	7,600	7,390	7,010
ECH35	324134	9,040	8,660	8,380
ECH40	324135	10,470	10,020	9,670
ECH50	324136	18,800	18,110	17,340

### STANDARD FLAGPOLE CONFIGURATION

1. Aluminum ball
2. Cast aluminum revolving truck
3. One halyard
4. Swivel snaps with covers
5. Cast aluminum cleat
6. 3000 PSI concrete (supplied by others)
7. Foundation sleeve
8. Dry tamped sand (supplied by others)
9. Steel base plate
10. Support plate
11. Grounding spike
12. Aluminum flash collar
13. Hardwood wedges (supplied by others)

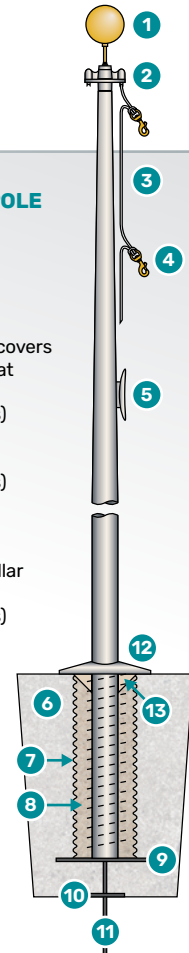

## ECONOMY EXTRA SERIES

### External Halyard Ground Set Cone Tapered Aluminum Flagpoles

#### STANDARD ACCESSORIES

- Gold anodized aluminum ball ornament
- Cast aluminum revolving truck with pulley
- Solid braided polyester halyard
- Swivel flag snaps with vinyl snap covers
- Cast aluminum cleat with mounting screws
- Spun aluminum flash collar
- Galvanized steel foundation sleeve

**Add \$64.00 to any of the flagpole prices on this page for double-cleat/double-halyard flagpoles.**

\* Flagpole models available in both one and two section styles; please specify when placing your order. Single section pole(s) will be shipped if not specified.

**Add 10% to the pricing for two section style flagpoles.**

\*\* Flagpole models available in multi-piece pole(s) only.

Model	Exposed Height	Overall Length	# of Sections	Butt Dia.	Top Dia.	Wall	Unflagged Max. Wind Speed	Flagged Max. Wind Speed	Suggested Flag Size	Shipping Weight
ECX20	20'	23'	1	5"	3"	.125	255 MPH	120+ MPH	3' x 5'	119 lbs.
ECX25	25'	27'	1	5"	3"	.125	137 MPH	105 MPH	4' x 6'	129 lbs.
ECX30	30'	33'	1 or 2*	5"	3"	.125	104 MPH	85 MPH	5' x 8'	154 lbs.
ECX35	35'	38-1/2'	1 or 2*	6"	3-1/2"	.156	119 MPH	91 MPH	6' x 10'	237 lbs.
ECX40	40'	44'	2**	7"	3-1/2"	.156	122 MPH	91 MPH	8' x 12'	272 lbs.
ECX50	50'	55'	3**	8"	3-1/2"	.188	118 MPH	85 MPH	10' x 15'	433 lbs.
ECX60	60'	66'	3**	10"	4"	.188	122 MPH	90 MPH	12' x 18'	665 lbs.
ECX70	70'	77'	3**	10"	4"	.312	127 MPH	91 MPH	15' x 25'	1032 lbs.

#### SATIN

Model	Item #	1-2	3-6	7+
ECX20	320193	\$2,140	\$2,020	\$1,870
ECX25	320194	2,230	2,140	2,000
ECX30	320195	2,480	2,390	2,230
ECX35	320196	3,840	3,660	3,380
ECX40	320197	5,620	5,340	5,040
ECX50	320198	7,970	7,550	7,130
ECX60	320199	11,560	11,170	10,390
ECX70	320200	18,540	17,620	16,680

#### CLEAR ANODIZED

Model	Item #	1-2	3-6	7+
ECX20	320201	\$2,600	\$2,500	\$2,370
ECX25	320202	2,830	2,680	2,500
ECX30	320203	3,180	3,050	2,910
ECX35	320204	4,720	4,480	4,260
ECX40	320205	6,690	6,450	6,060
ECX50	320206	9,590	9,140	8,650
ECX60	320207	13,910	13,230	12,530
ECX70	320208	21,670	20,600	19,440

#### BRONZE ANODIZED

Model	Item #	1-2	3-6	7+
ECX20	320209	\$2,690	\$2,530	\$2,410
ECX25	320210	2,890	2,730	2,560
ECX30	320211	3,210	3,090	2,890
ECX35	320212	4,840	4,610	4,330
ECX40	320213	7,000	6,630	6,280
ECX50	320214	9,910	9,390	8,880
ECX60	320215	14,390	13,690	12,900
ECX70	320216	22,120	21,020	19,940

#### BLACK ANODIZED

Model	Item #	1-2	3-6	7+
ECX20	320217	\$2,840	\$2,680	\$2,510
ECX25	320218	3,080	2,900	2,690
ECX30	320219	3,450	3,320	3,110
ECX35	320220	5,170	4,890	4,610
ECX40	320221	7,310	6,970	6,520
ECX50	320222	10,360	9,830	9,340
ECX60	320223	15,090	14,370	13,560
ECX70	320224	22,980	21,870	20,660

#### STANDARD FLAGPOLE CONFIGURATION

1. Aluminum ball
2. Cast aluminum revolving truck
3. One halyard
4. Swivel snaps with covers
5. Cast aluminum cleat
6. 3000 PSI concrete (supplied by others)
7. Foundation sleeve
8. Dry tamped sand (supplied by others)
9. Steel base plate
10. Support plate
11. Grounding spike
12. Aluminum flash collar
13. Hardwood wedges (supplied by others)

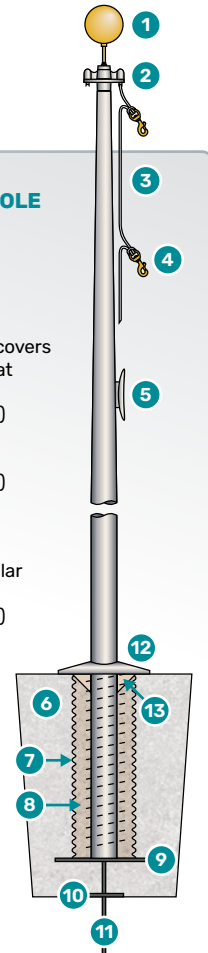

**ATLAS SERIES**

**External Halyard Ground Set Cone Tapered Aluminum Flagpoles**

**STANDARD ACCESSORIES**

- Gold anodized aluminum ball ornament
- Cast aluminum revolving truck with pulley (ECSA20 and ECSA25 supplied with cap style revolving truck)
- Solid braided polyester halyard
- Swivel flag snaps with vinyl snap covers
- Cast aluminum cleat with mounting screws
- Spun aluminum flash collar
- Galvanized steel foundation sleeve

**Add \$64.00 to any of the flagpole prices on this page for double-cleat/double-halyard flagpoles.**

\* Flagpole models available in both one and two section styles; please specify when placing your order. Single section pole(s) will be shipped if not specified.

**Add 10% to the pricing for two section style flagpoles.**

\*\* Flagpole models available in multi-piece pole(s) only.

Model	Exposed Height	Overall Length	# of Sections	Butt Dia.	Top Dia.	Wall	Unflagged Max. Wind Speed	Flagged Max. Wind Speed	Suggested Flag Size	Shipping Weight
ECSA20	20'	22'	1	4"	2-3/8"	.125	152 MPH	110 MPH	3' x 5'	92 lbs.
ECSA25	25'	27'	1	4"	2-3/8"	.125	113 MPH	88 MPH	4' x 6'	112 lbs.
ECXA25	25'	27'	1	5"	3"	.156	183 MPH	120 MPH	4' x 6'	147 lbs.
ECXA30	30'	33'	1 or 2*	5"	3"	.156	119 MPH	95 MPH	5' x 8'	162 lbs.
ECL30	30'	33'	1	5"	3"	.188	131 MPH	100 MPH	5' x 8'	180 lbs.
ECA30	30'	33'	1 or 2*	6"	3-1/2"	.156	184 MPH	115 MPH	5' x 8'	218 lbs.
ECSA35	35'	38-1/2'	1	5"	3"	.188	104 MPH	86 MPH	6' x 10'	228 lbs.
ECA35	35'	38-1/2'	1 or 2*	7"	3-1/2"	.156	175 MPH	114 MPH	6' x 10'	251 lbs.
ECA40	40'	44'	2**	8"	3-1/2"	.156	171 MPH	110 MPH	8' x 12'	298 lbs.
ECXA60	60'	66'	3**	10"	4"	.250	150 MPH	106 MPH	12' x 18'	754 lbs.

**SATIN**

Model	Item #	1-2	3-6	7+
ECSA20	320337	\$1,470	\$1,400	\$1,310
ECSA25	320338	1,670	1,580	1,490
ECXA25	320339	2,670	2,480	2,360
ECXA30	320340	3,000	2,830	2,680
ECL30	320884	3,200	3,050	2,890
ECA30	320341	3,680	3,510	3,300
ECSA35	320342	3,340	3,180	2,990
ECA35	320343	4,380	4,120	3,920
ECA40	320344	6,420	6,190	5,880
ECXA60	320345	14,650	14,000	13,200

**CLEAR ANODIZED**

Model	Item #	1-2	3-6	7+
ECSA20	320346	\$1,870	\$1,780	\$1,670
ECSA25	320347	2,140	2,030	1,950
ECXA25	320348	3,210	3,090	2,900
ECXA30	320349	3,610	3,450	3,240
ECL30	320885	3,750	3,610	3,360
ECA30	320350	4,480	4,270	4,020
ECSA35	320351	4,140	3,950	3,740
ECA35	320352	5,420	5,120	4,840
ECA40	320353	7,880	7,480	7,040
ECXA60	320354	17,260	16,410	15,560

**BRONZE ANODIZED**

Model	Item #	1-2	3-6	7+
ECSA20	320355	\$1,960	\$1,860	\$1,750
ECSA25	320356	2,280	2,130	1,990
ECXA25	320357	3,370	3,200	3,050
ECXA30	320358	3,790	3,570	3,390
ECL30	320886	3,940	3,740	3,550
ECA30	320359	4,610	4,390	4,160
ECSA35	320360	4,200	4,000	3,830
ECA35	320361	5,560	5,300	4,970
ECA40	320362	8,090	7,710	7,290
ECXA60	320363	17,640	16,740	15,950

**BLACK ANODIZED**

Model	Item #	1-2	3-6	7+
ECSA20	320364	\$2,060	\$1,960	\$1,850
ECSA25	320365	2,400	2,310	2,140
ECXA25	320366	3,450	3,290	3,110
ECXA30	320367	3,920	3,730	3,460
ECL30	320887	4,030	3,840	3,620
ECA30	320368	4,800	4,600	4,290
ECSA35	320369	4,470	4,200	4,000
ECA35	320370	5,860	5,570	5,300
ECA40	320371	8,520	8,090	7,680
ECXA60	320372	18,400	17,480	16,520

**STANDARD FLAGPOLE CONFIGURATION**

1. Aluminum ball
2. Cast aluminum revolving truck
3. One halyard
4. Swivel snaps with covers
5. Cast aluminum cleat
6. 3000 PSI concrete (supplied by others)
7. Foundation sleeve
8. Dry tamped sand (supplied by others)
9. Steel base plate
10. Support plate
11. Grounding spike
12. Aluminum flash collar
13. Hardwood wedges (supplied by others)

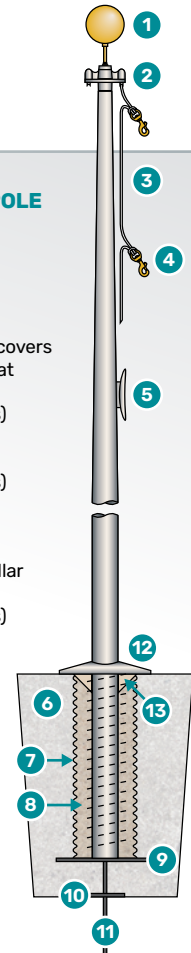

## SPECIAL BUDGET SERIES

### External Halyard Ground Set Cone Tapered Aluminum Flagpoles

#### STANDARD ACCESSORIES

- Gold anodized aluminum ball ornament
- Cast aluminum stationary truck with pulley (ECS35 has a revolving truck as standard)
- Solid braided polyester halyard
- Cast aluminum cleat with mounting screws
- Metal swivel flag snaps with vinyl covers
- Flash collar not included as standard equipment for this series
- PVC foundation sleeve (ECS30 & ECS35 poles have a galvanized steel sleeve as standard)

Add \$64.00 to any of the flagpole prices on this page for double-cleat/double-halyard flagpoles. Add \$40.00 for flash collar.

\* Flagpole models available in both one and two section styles; please specify when placing your order. Single section pole(s) will be shipped if not specified.

Add 10% to the pricing for two section style flagpoles.

\*\* Flagpole models also available in multi-piece pole(s). See [page 129](#) for three and four section model pricing.

Model	Exposed Height	Overall Length	# of Sections	Butt Dia.	Top Dia.	Wall	Unflagged Max. Wind Speed	Flagged Max. Wind Speed	Suggested Flag Size	Shipping Weight
ECSS15	15'	17'	1	3"	1-7/8"	.125	170 MPH	120 MPH	3' x 5'	45 lbs.
ECSS20	20'	22'	1 or 3**	3"	1-7/8"	.125	118 MPH	85 MPH	3' x 5'	54 lbs.
ECSS25	25'	27'	1 or 4**	3"	1-7/8"	.125	89 MPH	65 MPH	4' x 6'	64 lbs.
ECS20	20'	22'	1	3-1/2"	2-3/8"	.125	128 MPH	96 MPH	3' x 5'	61 lbs.
ECS25	25'	27'	1	3-1/2"	2-3/8"	.125	95 MPH	77 MPH	4' x 6'	73 lbs.
ECS30	30'	33'	1 or 2*	4"	2-3/8"	.125	88 MPH	50 MPH	5' x 8'	125 lbs.
ECS35	35'	38-1/2'	1 or 2*	5"	3"	.156	92 MPH	76 MPH	6' x 10'	213 lbs.

#### SATIN

MODEL	ITEM #	1-2	3-6	7+
ECSS15	320259	\$780	\$720	\$660
ECSS20	320260	900	870	840
ECSS25	320261	1,050	1,020	930
ECS20	320262	1,300	1,230	1,110
ECS25	320263	1,490	1,430	1,330
ECS30	320264	1,640	1,560	1,460
ECS35	320265	2,760	2,660	2,480

#### CLEAR ANODIZED

MODEL	ITEM #	1-2	3-6	7+
ECSS15	320268	\$1,020	\$940	\$910
ECSS20	320269	1,210	1,130	1,060
ECSS25	320270	1,460	1,370	1,320
ECS20	320271	1,670	1,600	1,490
ECS25	320272	1,940	1,850	1,690
ECS30	320273	2,180	2,060	1,940
ECS35	320274	3,530	3,390	3,180

#### BRONZE ANODIZED

MODEL	ITEM #	1-2	3-6	7+
ECSS15	320277	\$1,040	\$1,020	\$940
ECSS20	320278	1,280	1,210	1,120
ECSS25	320279	1,510	1,460	1,380
ECS20	320280	1,750	1,670	1,580
ECS25	320281	1,980	1,870	1,770
ECS30	320282	2,280	2,170	2,050
ECS35	320283	3,700	3,500	3,360

#### BLACK ANODIZED

MODEL	ITEM #	1-2	3-6	7+
ECSS15	320286	\$1,080	\$1,040	\$970
ECSS20	320287	1,370	1,320	1,210
ECSS25	320288	1,600	1,550	1,460
ECS20	320289	1,780	1,680	1,640
ECS25	320290	2,050	1,940	1,810
ECS30	320291	2,430	2,320	2,180
ECS35	320292	3,940	3,760	3,530

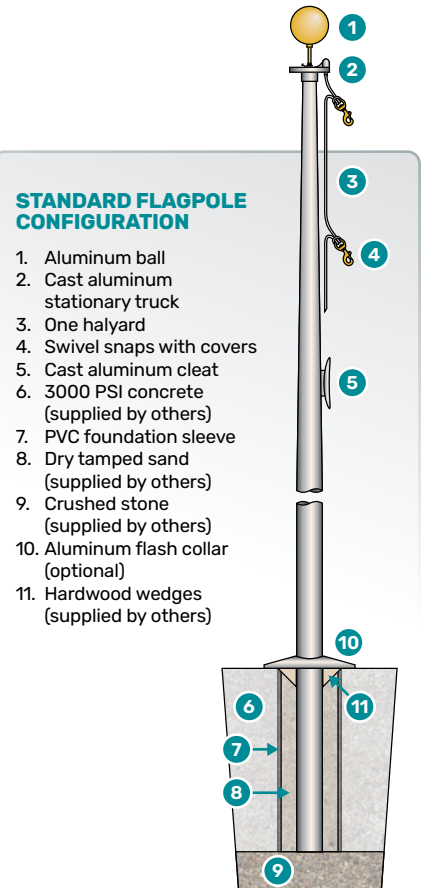

## SECTIONAL SPECIAL BUDGET SERIES

### External Halyard Ground Set Cone Tapered Aluminum Flagpoles

Looking for an excellent way to reduce your shipping costs on 20 ft. and 25 ft. aluminum flagpoles?

**Eder Flag's three section 20 ft. and four section 25 ft. Special Budget Series flagpoles can be shipped via parcel carrier!**

These popular poles are:

- Simple to install and come complete in a boxed set with all the standard accessories.
- Easy to store in your warehouse or backroom.
- Available in satin, clear, bronze and black anodized finishes.

This line of commercial grade flagpoles, manufactured using 6063-T6 aluminum tubing, can be used in both residential and commercial applications. These cone tapered flagpoles have the elements of a one piece pole with the advantage of low shipping costs.

**Add \$64.00 to any of the flagpole prices on this page for double-cleat/double-halyard flagpoles. Add \$40.00 for flash collar.**

#### Three Section ECSS20

Can be shipped via parcel carrier

Model	Item #	Finish	1-2	3-6	7+	Weight
SS20TS	320329	Satin	\$1,050	\$1,020	\$940	43 lbs.
SS20TS	320330	Clear	1,280	1,240	1,150	43 lbs.
SS20TS	320331	Bronze	1,330	1,300	1,240	43 lbs.
SS20TS	320332	Black	1,420	1,370	1,300	43 lbs.

#### Four Section ECSS25

Can be shipped via parcel carrier

Model	Item #	Finish	1-2	3-6	7+	Weight
SS25FS	323976	Satin	\$1,250	\$1,190	\$1,130	52 lbs.
SS25FS	323977	Clear	1,570	1,480	1,370	52 lbs.
SS25FS	323978	Bronze	1,590	1,510	1,410	52 lbs.
SS25FS	323979	Black	1,740	1,590	1,510	52 lbs.



### DELUXE LED SOLAR FLAGPOLE LIGHT

See [page 175](#) for more information.

## DELUXE IH SERIES WITH M-WINCH

### Internal Halyard Ground Set Cone Tapered Aluminum Flagpoles

These internal halyard flagpoles contain a winch mounted inside the flagpole shaft, operable only with a removable crank handle. As the stainless steel cable unwinds from the winch, it passes up through the inside of the flagpole shaft, over the truck sheave to the outside of the shaft, where the retainer ring provides a sliding anchor. A counterweight, heavily coated with neoprene, attached to the retainer ring, allows the halyard to be lowered for fastening or removing the flag. The winch is gearless and self-locking at any point, eliminating the need for a separate brake. This direct drive winch provides rapid raising and lowering of the flag with little effort. This design does not require any welding, thus avoiding discoloration when an anodized finish is desired. No monthly lubrication is needed.

#### STANDARD ACCESSORIES

- Cast aluminum revolving truck with enclosed stainless steel bearings and raceway
- Stainless steel cable assembly
- Deluxe flag arrangement
- Retainer ring and counterweight
- M-Winch system
- Spun aluminum flash collar
- Galvanized steel foundation sleeve
- See [page 145-146](#) for optional ornament selections

\* Flagpole models available in both one and two section styles; please specify when placing your order. Single section pole(s) will be shipped if not specified.

**Add 10% to the pricing for two section style flagpoles.**

\*\* Flagpole models available in multi-piece pole(s) only.

20' – 35' Poles

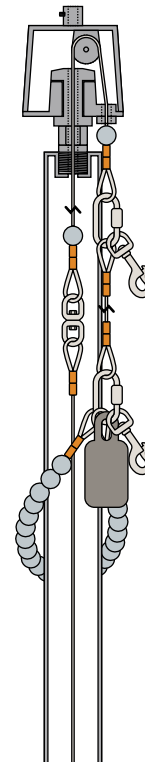

40' – 80' Poles

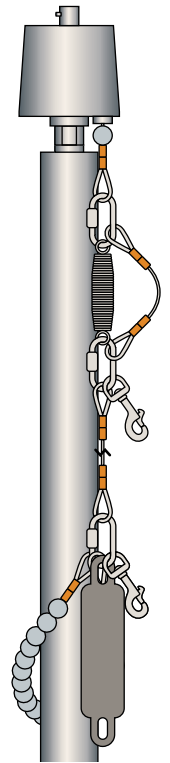

Model	Exposed Height	Overall Length	# of Sections	Butt Dia.	Top Dia.	Wall	Unflagged Max. Wind Speed	Flagged Max. Wind Speed	Suggested Flag Size	Shipping Weight
ECX20IH	20'	23'	1	5"	3"	.125	250 MPH	120+ MPH	3' x 5'	129 lbs.
EC20IH	20'	23'	1	5"	3"	.188	315 MPH	120+ MPH	3' x 5'	147 lbs.
ECX25IH	25'	27'	1	5"	3"	.125	144 MPH	104 MPH	4' x 6'	139 lbs.
ECXA25IH	25'	27'	1	5"	3"	.156	192 MPH	117 MPH	4' x 6'	157 lbs.
EC25IH	25'	27'	1	6"	3-1/2"	.188	222 MPH	120+ MPH	4' x 6'	195 lbs.
ECXA30IH	30'	33'	1 or 2*	5"	3"	.156	119 MPH	91 MPH	5' x 8'	187 lbs.
ECL30IH	30'	33'	1	5"	3"	.188	131 MPH	100 MPH	5' x 8'	190 lbs.
ECA30IH	30'	33'	1 or 2*	6"	3-1/2"	.156	184 MPH	117 MPH	5' x 8'	239 lbs.
EC30IH	30'	33'	1 or 2*	6"	3-1/2"	.188	211 MPH	120+ MPH	5' x 8'	242 lbs.
ECSA35IH	35'	38-1/2'	1	5"	3"	.188	104 MPH	86 MPH	6' x 10'	241 lbs.
ECX35IH	35'	38-1/2'	1 or 2*	6"	3-1/2"	.156	122 MPH	91 MPH	6' x 10'	261 lbs.
ECA35IH	35'	38-1/2'	1 or 2*	7"	3-1/2"	.156	179 MPH	117 MPH	6' x 10'	280 lbs.
EC35IH	35'	38-1/2'	1 or 2*	7"	3-1/2"	.188	200 MPH	120 MPH	6' x 10'	290 lbs.
ECX40IH	40'	44'	2**	7"	3-1/2"	.156	125 MPH	91 MPH	8' x 12'	282 lbs.
ECA40IH	40'	44'	2**	8"	3-1/2"	.156	171 MPH	110 MPH	8' x 12'	319 lbs.
EC40IH	40'	44'	2**	8"	3-1/2"	.188	203 MPH	120 MPH	8' x 12'	319 lbs.
EC45IH	45'	49-1/2'	2**	8"	3-1/2"	.188	166 MPH	100 MPH	8' x 12'	371 lbs.
ECX50IH	50'	55'	3**	8"	3-1/2"	.188	118 MPH	85 MPH	10' x 15'	443 lbs.
EC50IH	50'	55'	3**	10"	4"	.188	185 MPH	115 MPH	10' x 15'	523 lbs.
ECX60IH	60'	66'	3**	10"	4"	.188	122 MPH	90 MPH	12' x 18'	675 lbs.
ECXA60IH	60'	66'	3**	10"	4"	.250	150 MPH	106 MPH	12' x 18'	764 lbs.
EC60IH	60'	66'	3**	12"	4"	.250	213 MPH	120 MPH	12' x 18'	843 lbs.
ECX70IH	70'	77'	3**	10"	4"	.312	127 MPH	91 MPH	15' x 25'	1042 lbs.
EC70IH	70'	77'	3**	12"	4"	.250	169 MPH	105 MPH	15' x 25'	988 lbs.
EC80IH	80'	88'	3**	12"	4"	.375	174 MPH	105 MPH	20' x 30'	1367 lbs.

## DELUXE IH SERIES WITH M-WINCH

Internal Halyard Ground Set Cone Tapered Aluminum Flagpoles

### SATIN

Model	Item #	1-2	3-6	7+
ECX20IH	320473	\$3,460	\$3,280	\$3,100
EC20IH	320474	4,100	3,940	3,710
ECX25IH	320475	3,820	3,640	3,380
ECXA25IH	320476	4,190	3,950	3,770
EC25IH	320477	6,060	5,790	5,480
ECXA30IH	320479	4,510	4,290	4,070
ECL30IH	320892	4,790	4,570	4,370
ECA30IH	320480	6,850	6,480	6,150
EC30IH	320481	7,040	6,710	6,360
ECSA35IH	320482	4,970	4,730	4,480
ECX35IH	320483	6,990	6,650	6,290
ECA35IH	320484	7,360	7,010	6,630
EC35IH	320485	8,290	7,860	7,430
ECX40IH	320486	8,670	8,230	7,780
ECA40IH	320487	9,900	9,400	8,890
EC40IH	320488	10,020	9,530	9,020
EC45IH	320489	10,510	9,960	9,400
ECX50IH	320490	11,000	10,400	9,860
EC50IH	320491	13,250	12,540	11,930
ECX60IH	320492	15,600	14,800	14,000
ECXA60IH	320493	19,110	18,170	17,200
EC60IH	320494	23,700	22,520	21,290
ECX70IH	320495	21,660	20,560	19,450
EC70IH	320496	25,840	24,490	23,090
EC80IH	320497	33,400	31,300	29,700

### CLEAR ANODIZED

Model	Item #	1-2	3-6	7+
ECX20IH	320498	\$4,050	\$3,920	\$3,630
EC20IH	320499	4,720	4,490	4,270
ECX25IH	320500	4,450	4,200	4,000
ECXA25IH	320501	4,880	4,630	4,370
EC25IH	320502	6,960	6,650	6,290
ECXA30IH	320504	5,280	5,070	4,720
ECL30IH	320893	5,500	5,260	4,920
ECA30IH	320505	7,900	7,470	7,080
EC30IH	320506	8,140	7,720	7,270
ECSA35IH	320507	5,910	5,590	5,320
ECX35IH	320508	8,120	7,670	7,260
ECA35IH	320509	8,600	8,210	7,770
EC35IH	320510	9,590	9,140	8,600
ECX40IH	320511	10,070	9,560	9,060
ECA40IH	320512	11,460	10,910	10,300
EC40IH	320513	11,570	11,040	10,430
EC45IH	320514	12,250	11,680	11,040
ECX50IH	320515	12,900	12,360	11,690
EC50IH	320516	15,560	14,800	14,030
ECX60IH	320517	18,190	17,290	16,360
ECXA60IH	320518	22,010	20,910	19,760
EC60IH	320519	27,200	25,890	24,460
ECX70IH	320520	25,000	23,740	22,500
EC70IH	320521	29,960	28,440	26,970
EC80IH	320522	38,150	36,240	34,340

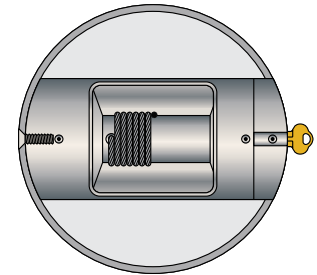

M-Winch Detail

### BRONZE ANODIZED

Model	Item #	1-2	3-6	7+
ECX20IH	320523	\$4,130	\$3,950	\$3,730
EC20IH	320524	4,790	4,600	4,360
ECX25IH	320525	4,560	4,330	4,070
ECXA25IH	320526	4,970	4,720	4,480
EC25IH	320527	7,090	6,690	6,350
ECXA30IH	320529	5,440	5,170	4,890
ECL30IH	320894	5,640	5,340	5,100
ECA30IH	320530	7,990	7,580	7,150
EC30IH	320531	8,210	7,800	7,410
ECSA35IH	320532	5,970	5,640	5,400
ECX35IH	320533	8,230	7,880	7,410
ECA35IH	320534	8,790	8,420	7,930
EC35IH	320535	9,780	9,310	8,740
ECX40IH	320536	10,250	9,720	9,240
ECA40IH	320537	11,690	11,120	10,490
EC40IH	320538	11,820	11,260	10,630
EC45IH	320539	12,530	11,890	11,280
ECX50IH	320540	13,230	12,590	11,910
EC50IH	320541	15,960	15,110	14,350
ECX60IH	320542	18,790	17,840	16,880
ECXA60IH	320543	22,620	21,540	20,350
EC60IH	320544	27,920	26,540	25,170
ECX70IH	320545	25,720	24,470	23,140
EC70IH	320546	30,810	29,290	27,740
EC80IH	320547	39,180	37,210	35,010

### BLACK ANODIZED

Model	Item #	1-2	3-6	7+
ECX20IH	320548	\$4,280	\$4,050	\$3,850
EC20IH	320549	4,960	4,690	4,460
ECX25IH	320550	4,700	4,470	4,200
ECXA25IH	320551	5,110	4,880	4,600
EC25IH	320552	7,210	6,840	6,470
ECXA30IH	320554	5,590	5,330	5,040
ECL30IH	320895	5,810	5,540	5,240
ECA30IH	320555	8,220	7,830	7,390
EC30IH	320556	8,460	8,040	7,580
ECSA35IH	320557	6,250	5,920	5,570
ECX35IH	320558	8,510	8,130	7,670
ECA35IH	320559	9,110	8,600	8,150
EC35IH	320560	10,040	9,530	9,060
ECX40IH	320561	10,600	10,070	9,530
ECA40IH	320562	12,060	11,450	10,810
EC40IH	320563	12,200	11,560	10,940
EC45IH	320564	12,890	12,300	11,680
ECX50IH	320565	13,660	12,940	12,260
EC50IH	320566	16,530	15,670	14,850
ECX60IH	320567	19,300	18,330	17,400
ECXA60IH	320568	23,110	21,960	20,780
EC60IH	320569	28,540	27,040	25,560
ECX70IH	320570	26,240	24,960	23,580
EC70IH	320571	31,370	29,880	28,410
EC80IH	320572	39,660	37,710	35,710

## HURRICANE DELUXE IH SERIES WITH M-WINCH

### Internal Halyard Ground Set Cone Tapered Aluminum Flagpoles

These internal halyard flagpoles contain a winch mounted inside the flagpole shaft, operable only with a removable crank handle. As the stainless steel cable unwinds from the winch, it passes up through the inside of the flagpole shaft, over the truck sheave to the outside of the shaft, where the retainer ring provides a sliding anchor. A counterweight, heavily coated with neoprene, attached to the retainer ring, allows the halyard to be lowered for fastening or removing the flag. The winch is gearless and self-locking at any point, eliminating the need for a separate brake. This direct drive winch provides rapid raising and lowering of the flag with little effort. This design does not require any welding, thus avoiding discoloration when an anodized finish is desired. No monthly lubrication is needed.

#### STANDARD ACCESSORIES

- Cast aluminum revolving truck with enclosed stainless steel bearings and raceway
- Stainless steel cable assembly
- Deluxe flag arrangement
- Retainer ring and counterweight
- M-Winch system
- Spun aluminum flash collar
- Galvanized steel foundation sleeve
- See [pages 145-146](#) for optional ornament selections

Model	Exposed Height	Overall Length	# of Sections	Butt Dia.	Top Dia.	Wall	Unflagged Max. Wind Speed	Flagged Max. Wind Speed	Suggested Flag Size	Shipping Weight
ECH25IH	25'	27'	1	6"	3-1/2"	.250	255 MPH	150+ MPH	4' x 6'	243 lbs.
ECH30IH	30'	33'	2	6"	3-1/2"	.250	241 MPH	150+ MPH	5' x 8'	322 lbs.
ECH35IH	35'	38-1/2'	2	8"	3-1/2"	.250	255 MPH	150 MPH	6' x 10'	361 lbs.
ECH40IH	40'	44'	2	8"	3-1/2"	.250	231 MPH	150 MPH	8' x 12'	419 lbs.
ECH50IH	50'	55'	3	10"	4"	.312	230 MPH	150 MPH	10' x 15'	686 lbs.

#### SATIN

Model	Item #	1-2	3-6	7+
ECH25IH	324137	\$7,470	\$7,220	\$6,980
ECH30IH	324138	9,320	8,960	8,600
ECH35IH	324139	10,180	9,730	9,370
ECH40IH	324140	11,610	11,140	10,700
ECH50IH	324141	19,020	18,220	17,510

#### CLEAR ANODIZED

Model	Item #	1-2	3-6	7+
ECH25IH	324142	\$8,230	\$7,920	\$7,580
ECH30IH	324143	10,290	9,900	9,500
ECH35IH	324144	11,480	11,010	10,560
ECH40IH	324145	13,140	12,610	12,120
ECH50IH	324146	21,340	20,450	19,660

#### BRONZE ANODIZED

Model	Item #	1-2	3-6	7+
ECH25IH	324147	\$8,470	\$8,160	\$7,780
ECH30IH	324148	10,470	10,020	9,670
ECH35IH	324149	11,780	11,350	10,850
ECH40IH	324150	13,510	12,940	12,470
ECH50IH	324151	21,880	21,030	20,150

#### BLACK ANODIZED

Model	Item #	1-2	3-6	7+
ECH25IH	324152	\$8,740	\$8,420	\$8,050
ECH30IH	324153	10,820	10,390	9,960
ECH35IH	324154	12,260	11,790	11,350
ECH40IH	324155	14,080	13,530	12,920
ECH50IH	324156	22,660	21,780	20,910

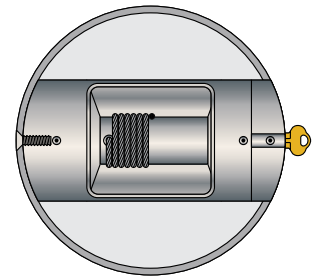

M-Winch Detail

The Vanguard Series provides an intelligent, economical alternative to deluxe internal halyard systems.

## VANGUARD SERIES

Internal Halyard Ground Set Cone Tapered Aluminum Flagpoles

### STANDARD ACCESSORIES

- Gold anodized aluminum ball ornament
- Cast aluminum revolving truck with enclosed stainless steel bearings and raceway
- Polyester wire center halyard
- Swivel flag snaps with vinyl snap covers
- Retainer ring and counterweight
- Stainless steel quick link
- Cam action cleat (accessible behind a lockable access door)
- Spun aluminum flash collar
- Galvanized steel foundation sleeve

\* Flagpole models available in both one and two section styles; please specify when placing your order. Single section pole(s) will be shipped if not specified.

**Add 10% to the pricing for two section style flagpoles.**

\*\* Flagpole models available in multi-piece pole(s) only.

Model	Exposed Height	Overall Length	# of Sections	Butt Dia.	Top Dia.	Wall	Unflagged Max. Wind Speed	Flagged Max. Wind Speed	Suggested Flag Size	Shipping Weight
ECXV20	20'	23'	1	5"	3"	.125	250 MPH	120+ MPH	3' x 5'	129 lbs.
ECV20	20'	23'	1	5"	3"	.188	315 MPH	120+ MPH	3' x 5'	142 lbs.
ECXV25	25'	27'	1	5"	3"	.125	144 MPH	104 MPH	4' x 6'	139 lbs.
ECXAV25	25'	27'	1	5"	3"	.156	192 MPH	117 MPH	4' x 6'	152 lbs.
ECV25	25'	27'	1	6"	3-1/2"	.188	222 MPH	120+ MPH	4' x 6'	197 lbs.
ECXAV30	30'	33'	1 or 2*	5"	3"	.156	119 MPH	91 MPH	5' x 8'	185 lbs.
ECLV30	30'	33'	1	5"	3"	.188	127 MPH	96 MPH	5' x 8'	185 lbs.
ECAV30	30'	33'	1	6"	3-1/2"	.156	184 MPH	117 MPH	5' x 8'	224 lbs.
ECV30	30'	33'	1	6"	3-1/2"	.188	211 MPH	120+ MPH	5' x 8'	227 lbs.
ECXV35	35'	38-1/2'	1	6"	3-1/2"	.156	122 MPH	91 MPH	6' x 10'	247 lbs.
ECAV35	35'	38-1/2'	1	7"	3-1/2"	.156	179 MPH	117 MPH	6' x 10'	261 lbs.
ECV35	35'	38-1/2'	1	7"	3-1/2"	.188	200 MPH	120 MPH	6' x 10'	281 lbs.
ECXV40	40'	44'	2**	7"	3-1/2"	.156	125 MPH	91 MPH	8' x 12'	294 lbs.
ECV40	40'	44'	2**	8"	3-1/2"	.188	195 MPH	120 MPH	8' x 12'	319 lbs.

### SATIN

Model	Item #	1-2	3-6	7+
ECXV20	320409	\$2,770	\$2,530	\$2,450
ECV20	320410	3,320	3,170	2,990
ECXV25	320411	3,060	2,890	2,770
ECXAV25	320412	3,400	3,250	3,070
ECV25	320413	4,490	4,270	4,050
ECXAV30	320415	3,790	3,560	3,380
ECLV30	320888	3,960	3,790	3,630
ECAV30	320416	4,380	4,130	3,940
ECV30	320417	4,630	4,440	4,180
ECXV35	320419	4,630	4,440	4,180
ECAV35	320420	5,230	4,940	4,720
ECV35	320421	5,990	5,640	5,350
ECXV40	320422	6,450	6,170	5,790
ECV40	320424	7,950	7,480	7,130

### CLEAR ANODIZED

Model	Item #	1-2	3-6	7+
ECXV20	320425	\$3,250	\$3,120	\$3,000
ECV20	320426	3,960	3,740	3,570
ECXV25	320427	3,630	3,460	3,260
ECXAV25	320428	4,100	3,940	3,720
ECV25	320429	5,150	4,880	4,610
ECXAV30	320431	4,510	4,260	4,070
ECLV30	320889	4,650	4,380	4,210
ECAV30	320432	5,300	5,020	4,720
ECV30	320433	5,570	5,280	5,000
ECXV35	320435	5,640	5,360	5,120
ECAV35	320436	6,320	6,010	5,630
ECV35	320437	7,080	6,680	6,340
ECXV40	320438	7,720	7,350	6,970
ECV40	320440	9,450	8,950	8,500

### BRONZE ANODIZED

Model	Item #	1-2	3-6	7+
ECXV20	320441	\$3,370	\$3,230	\$3,050
ECV20	320442	4,070	3,840	3,610
ECXV25	320443	3,810	3,560	3,390
ECXAV25	320444	4,200	4,020	3,810
ECV25	320445	5,210	4,970	4,680
ECXAV30	320447	4,650	4,450	4,180
ECLV30	320890	4,730	4,520	4,370
ECAV30	320448	5,340	5,070	4,830
ECV30	320449	5,640	5,360	5,120
ECXV35	320451	5,790	5,490	5,210
ECAV35	320452	6,520	6,160	5,820
ECV35	320453	7,290	6,920	6,570
ECXV40	320454	7,940	7,530	7,150
ECV40	320456	9,630	9,170	8,650

### BLACK ANODIZED

Model	Item #	1-2	3-6	7+
ECXV20	320457	\$3,460	\$3,260	\$3,120
ECV20	320458	4,180	3,940	3,670
ECXV25	320459	3,960	3,750	3,470
ECXAV25	320460	4,380	4,140	3,950
ECV25	320461	5,430	5,150	4,870
ECXAV30	320463	4,830	4,570	4,330
ECLV30	320891	4,920	4,700	4,510
ECAV30	320464	5,610	5,330	5,070
ECV30	320465	5,920	5,620	5,340
ECXV35	320467	6,120	5,770	5,450
ECAV35	320468	6,800	6,450	6,140
ECV35	320469	7,580	7,240	6,800
ECXV40	320470	8,270	7,830	7,410
ECV40	320472	9,960	9,500	8,990



5" Poles

6" Poles



7-8" Poles

5" diameter poles supplied with a hinged access door and frame unit. 6" and larger diameter poles supplied with a removable flush-mounted access door which is internally framed for added strength.

If ordering three or more flagpoles that are different models, please contact a sales representative to inquire about our quantity discount.

## NAUTICAL SERIES WITH YARDARM

### External Halyard Ground Set Cone Tapered Aluminum Flagpoles

#### STANDARD ACCESSORIES

- Gold anodized aluminum ball ornament
- Cast aluminum revolving truck with pulley
- Aluminum yardarm with pulleys and mounting hardware
- 3 lengths of solid braided polyester halyard
- Swivel flag snaps with vinyl snap covers
- 3 cast aluminum cleats with mounting screws
- Spun aluminum flash collar
- Galvanized steel foundation sleeve

\* Flagpole models available in both one and two section styles; please specify when placing your order. Single section pole(s) will be shipped if not specified. **Add 10% to the pricing for two section style flagpoles.**

\*\* Flagpole models available in multi-piece pole(s) only.

♦ Yardarm Center diameter is 3-1/2", End diameter is 2"

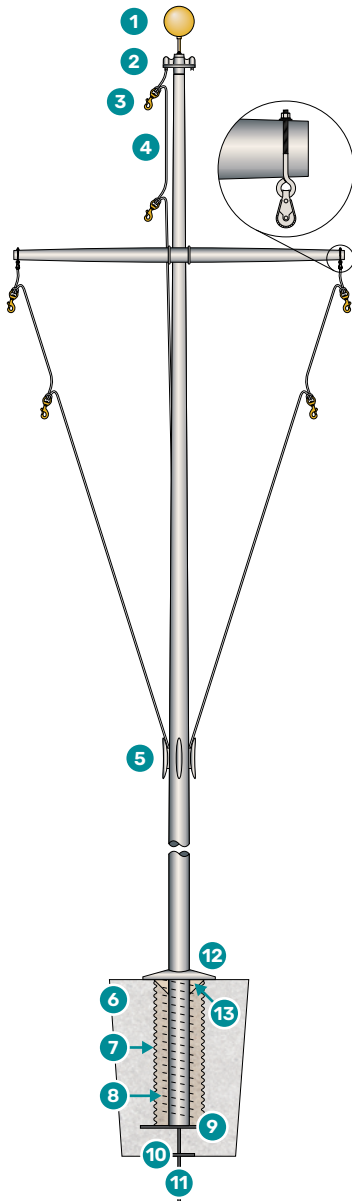

Model	Exposed Height	Overall Length	# of Sections	Butt Dia.	Top Dia.	Wall	♦Yardarm Length	Shipping Weight
ECXP20-Y	20'	23'	1	5"	3"	.125	6'	155 lbs.
ECP20-Y	20'	23'	1	5"	3"	.188	6'	173 lbs.
ECXP25-Y	25'	27'	1	5"	3"	.125	6-1/2'	167 lbs.
ECXAP25-Y	25'	27'	1	5"	3"	.156	6-1/2'	185 lbs.
ECP25-Y	25'	27'	1	6"	3-1/2"	.188	6-1/2'	233 lbs.
ECXP30-Y	30'	33'	1 or 2*	5"	3"	.125	8-1/2'	194 lbs.
ECXAP30-Y	30'	33'	1 or 2*	5"	3"	.156	8-1/2'	202 lbs.
ECAP30-Y	30'	33'	1 or 2*	6"	3-1/2"	.156	8-1/2'	254 lbs.
ECP30-Y	30'	33'	1 or 2*	6"	3-1/2"	.188	8-1/2'	257 lbs.
ECSAP35-Y	35'	38-1/2'	1	5"	3"	.188	9-1/2'	262 lbs.
ECXP35-Y	35'	38-1/2'	1 or 2*	6"	3-1/2"	.156	9-1/2'	280 lbs.
ECAP35-Y	35'	38-1/2'	1 or 2*	7"	3-1/2"	.156	9-1/2'	299 lbs.
ECP35-Y	35'	38-1/2'	1 or 2*	7"	3-1/2"	.188	9-1/2'	319 lbs.
ECXP40-Y	40'	44'	2**	7"	3-1/2"	.156	11'	324 lbs.
ECP40-Y	40'	44'	2**	8"	3-1/2"	.188	11'	361 lbs.
ECP45-Y	45'	49-1/2'	2**	8"	3-1/2"	.188	11'	413 lbs.

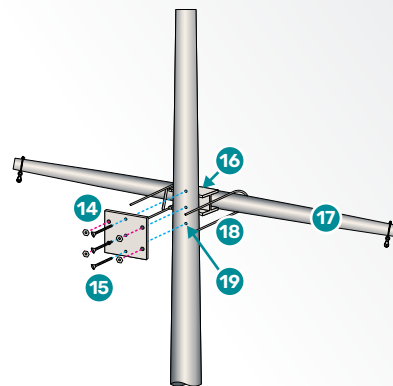

#### STANDARD FLAGPOLE CONFIGURATION

1. Aluminum ball
2. Cast aluminum revolving truck
3. Swivel snaps with covers
4. Three halyards
5. Three cast aluminum cleats
6. 3000 PSI concrete (supplied by others)
7. Foundation sleeve
8. Dry tamped sand (supplied by others)
9. Steel base plate
10. Support plate
11. Grounding spike
12. Aluminum flash collar
13. Hardwood wedges (supplied by others)

#### Yardarm Assembly Detail

14. Yardarm plate
15. 1/4 x 20 flat head screws (included)
16. V-slot on welded H-beam
17. Yardarm assembly
18. U-bolts (2 required)
19. Pre-drilled tapped holes

**NAUTICAL SERIES WITH YARDARM**

**External Halyard Ground Set Cone Tapered Aluminum Flagpoles**

NOTE: All pole pricing below includes the yardarm. See [page 138](#) for pricing on yardarms only.

**SATIN**

Model	Item #	1-2	3-6	7+
ECXP20-Y	320573	\$3,540	\$3,340	\$3,150
ECP20-Y	320574	4,190	3,980	3,770
ECXP25-Y	320575	3,760	3,540	3,300
ECXAP25-Y	320576	4,190	3,940	3,740
ECP25-Y	320577	4,950	4,720	4,440
ECXP30-Y	320578	4,120	3,950	3,710
ECXAP30-Y	320579	4,630	4,390	4,110
ECAP30-Y	320580	5,300	5,100	4,730
ECP30-Y	320581	5,430	5,170	4,830
ECSAP35-Y	320582	5,010	4,780	4,480
ECXP35-Y	320583	5,480	5,230	4,840
ECAP35-Y	320584	6,050	5,750	5,410
ECP35-Y	320585	6,720	6,400	6,050
ECXP40-Y	320586	7,470	7,130	6,720
ECP40-Y	320588	8,400	8,050	7,630
ECP45-Y	320589	9,220	8,780	8,300

**CLEAR ANODIZED**

Model	Item #	1-2	3-6	7+
ECXP20-Y	320598	\$4,390	\$4,160	\$3,960
ECP20-Y	320599	5,110	4,880	4,610
ECXP25-Y	320600	4,660	4,470	4,140
ECXAP25-Y	320601	5,040	4,840	4,560
ECP25-Y	320602	6,060	5,710	5,420
ECXP30-Y	320603	5,230	4,960	4,730
ECXAP30-Y	320604	5,670	5,390	5,040
ECAP30-Y	320605	6,500	6,220	5,840
ECP30-Y	320606	6,650	6,340	5,960
ECSAP35-Y	320607	6,260	5,920	5,570
ECXP35-Y	320608	6,840	6,450	6,140
ECAP35-Y	320609	7,530	7,110	6,660
ECP35-Y	320610	8,270	7,900	7,410
ECXP40-Y	320611	9,120	8,720	8,200
ECP40-Y	320613	10,320	9,810	9,240
ECP45-Y	320614	11,210	10,610	10,040

**BRONZE ANODIZED**

Model	Item #	1-2	3-6	7+
ECXP20-Y	320623	\$4,490	\$4,270	\$4,050
ECP20-Y	320624	5,220	4,970	4,690
ECXP25-Y	320625	4,790	4,600	4,290
ECXAP25-Y	320626	5,330	5,000	4,780
ECP25-Y	320627	6,170	5,940	5,570
ECXP30-Y	320628	5,390	5,170	4,830
ECXAP30-Y	320629	5,950	5,670	5,360
ECAP30-Y	320630	6,800	6,450	6,140
ECP30-Y	320631	6,960	6,590	6,240
ECSAP35-Y	320632	6,500	6,170	5,860
ECXP35-Y	320633	7,160	6,800	6,350
ECAP35-Y	320634	7,840	7,470	7,070
ECP35-Y	320635	8,650	8,200	7,740
ECXP40-Y	320636	9,610	9,140	8,640
ECP40-Y	320638	10,770	10,250	9,690
ECP45-Y	320639	11,700	11,090	10,510

**BLACK ANODIZED**

Model	Item #	1-2	3-6	7+
ECXP20-Y	320648	\$4,720	\$4,490	\$4,200
ECP20-Y	320649	5,450	5,220	4,910
ECXP25-Y	320650	5,110	4,800	4,510
ECXAP25-Y	320651	5,510	5,230	4,910
ECP25-Y	320652	6,590	6,240	5,900
ECXP30-Y	320653	5,770	5,500	5,170
ECXAP30-Y	320654	6,220	5,900	5,540
ECAP30-Y	320655	7,110	6,760	6,340
ECP30-Y	320656	7,360	6,990	6,590
ECSAP35-Y	320657	6,840	6,480	6,150
ECXP35-Y	320658	7,530	7,180	6,680
ECAP35-Y	320659	8,220	7,840	7,410
ECP35-Y	320660	9,060	8,570	8,120
ECXP40-Y	320661	10,040	9,580	8,990
ECP40-Y	320663	11,360	10,770	10,210
ECP45-Y	320664	12,330	11,730	11,080

## NAUTICAL SERIES WITH YARDARM & GAFF

### External Halyard Ground Set Cone Tapered Aluminum Flagpoles

#### STANDARD ACCESSORIES

- Gold anodized aluminum ball ornament
- Cast aluminum revolving truck with pulley
- Aluminum yardarm and gaff with pulleys and mounting hardware
- 4 lengths of solid braided polyester halyard
- Swivel flag snaps with vinyl snap covers
- 4 cast aluminum cleats with mounting screws
- Spun aluminum flash collar
- Galvanized steel foundation sleeve

\* Flagpole models available in both one and two section styles; please specify when placing your order. Single section pole(s) will be shipped if not specified. **Add 10% to the pricing for two section style flagpoles.**

\*\* Flagpole models available in multi-piece pole(s) only.

- ◆ Yardarm Center diameter is 3-1/2", End diameter is 2"
- Gaff Butt diameter is 3-1/2", Top diameter is 2"

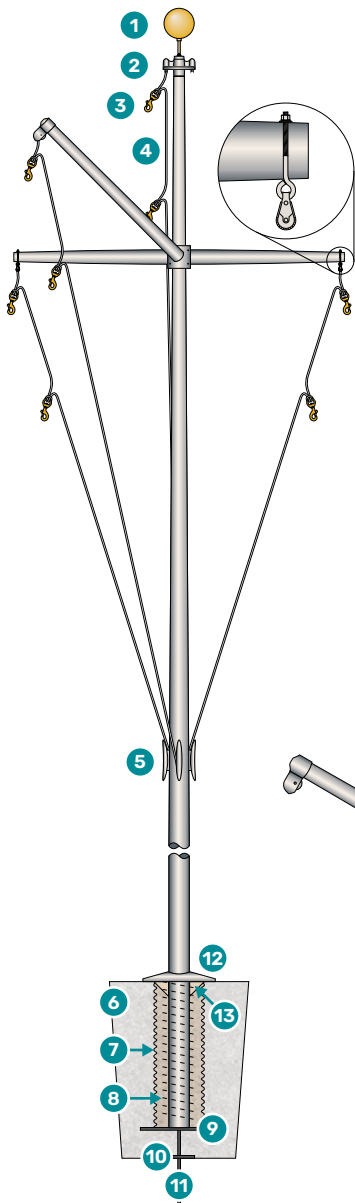

Model	Exp. Height	Overall Length	# of Sections	Butt Dia.	Top Dia.	Wall	◆ Yardarm Length	■ Gaff Length	Shipping Weight
ECXP20-YG	20'	23'	1	5"	3"	.125	6'	5'	185 lbs.
ECP20-YG	20'	23'	1	5"	3"	.188	6'	5'	203 lbs.
ECXP25-YG	25'	27'	1	5"	3"	.125	6-1/2'	5-1/2'	217 lbs.
ECXAP25-YG	25'	27'	1	5"	3"	.156	6-1/2'	5-1/2'	217 lbs.
ECP25-YG	25'	27'	1	6"	3-1/2"	.188	6-1/2'	5-1/2'	263 lbs.
ECXP30-YG	30'	33'	1 or 2*	5"	3"	.125	8-1/2'	6-1/2'	227 lbs.
ECXAP30-YG	30'	33'	1 or 2*	5"	3"	.156	8-1/2'	6-1/2'	235 lbs.
ECAP30-YG	30'	33'	1 or 2*	6"	3-1/2"	.156	8-1/2'	6-1/2'	279 lbs.
ECP30-YG	30'	33'	1 or 2*	6"	3-1/2"	.188	8-1/2'	6-1/2'	290 lbs.
ECSAP35-YG	35'	38-1/2'	1	5"	3"	.188	9-1/2'	7-1/2'	289 lbs.
ECXP35-YG	35'	38-1/2'	1 or 2*	6"	3-1/2"	.156	9-1/2'	7-1/2'	307 lbs.
ECAP35-YG	35'	38-1/2'	1 or 2*	7"	3-1/2"	.156	9-1/2'	7-1/2'	336 lbs.
ECP35-YG	35'	38-1/2'	1 or 2*	7"	3-1/2"	.188	9-1/2'	7-1/2'	356 lbs.
ECXP40-YG	40'	44'	2**	7"	3-1/2"	.156	11'	9'	366 lbs.
ECP40-YG	40'	44'	2**	8"	3-1/2"	.188	11'	9'	403 lbs.
ECP45-YG	45'	49-1/2'	2**	8"	3-1/2"	.188	11'	9'	455 lbs.

#### STANDARD FLAGPOLE CONFIGURATION

1. Aluminum ball
2. Cast aluminum revolving truck
3. Swivel snaps with covers
4. Four halyards
5. Four cast aluminum cleats
6. 3000 PSI concrete (supplied by others)
7. Foundation sleeve
8. Dry tamped sand (supplied by others)
9. Steel base plate
10. Support plate
11. Grounding spike
12. Aluminum flash collar
13. Hardwood wedges (supplied by others)

#### Yardarm & Gaff Assembly Detail

14. Yardarm plate
15. Gaff
16. 1/4 x 20 flat head screws (included)
17. V-slot on welded H-beam
18. Yardarm assembly
19. U-bolts (2 required)
20. Pre-drilled tapped holes

## NAUTICAL SERIES WITH YARDARM & GAFF

### External Halyard Ground Set Cone Tapered Aluminum Flagpoles

NOTE: All pole pricing below includes the yardarm and gaff. See [page 138](#) for pricing on yardarms and gaffs only.

#### SATIN

Model	Item #	1-2	3-6	7+
ECXP20-YG	320673	\$4,520	\$4,280	\$4,000
ECP20-YG	320674	5,220	4,950	4,640
ECXP25-YG	320675	4,780	4,520	4,210
ECXAP25-YG	320676	5,230	4,940	4,630
ECP25-YG	320677	6,030	5,750	5,430
ECXP30-YG	320678	5,290	5,040	4,690
ECXAP30-YG	320679	5,800	5,450	5,140
ECAP30-YG	320680	6,430	6,150	5,750
ECP30-YG	320681	6,540	6,250	5,850
ECSAP35-YG	320682	6,170	5,890	5,480
ECXP35-YG	320683	6,660	6,350	5,880
ECAP35-YG	320684	7,190	6,880	6,430
ECP35-YG	320685	7,960	7,570	7,070
ECXP40-YG	320686	8,700	8,310	7,830
ECP40-YG	320688	9,620	9,270	8,670
ECP45-YG	320689	10,440	9,960	9,370

#### CLEAR ANODIZED

Model	Item #	1-2	3-6	7+
ECXP20-YG	320698	\$5,620	\$5,360	\$5,040
ECP20-YG	320699	6,440	6,140	5,750
ECXP25-YG	320700	6,000	5,750	5,360
ECXAP25-YG	320701	6,420	6,160	5,750
ECP25-YG	320702	7,480	7,080	6,680
ECXP30-YG	320703	6,650	6,340	6,050
ECXAP30-YG	320704	7,150	6,760	6,350
ECAP30-YG	320705	7,990	7,570	7,150
ECP30-YG	320706	8,150	7,740	7,270
ECSAP35-YG	320707	7,770	7,360	6,960
ECXP35-YG	320708	8,330	7,930	7,480
ECAP35-YG	320709	9,040	8,560	8,120
ECP35-YG	320710	9,790	9,360	8,770
ECXP40-YG	320711	10,770	10,250	9,650
ECP40-YG	320713	11,960	11,350	10,710
ECP45-YG	320714	12,840	12,190	11,490

#### BRONZE ANODIZED

Model	Item #	1-2	3-6	7+
ECXP20-YG	320723	\$5,820	\$5,560	\$5,260
ECP20-YG	320724	6,600	6,280	5,940
ECXP25-YG	320725	6,260	5,950	5,600
ECXAP25-YG	320726	6,790	6,370	6,060
ECP25-YG	320727	7,690	7,360	6,890
ECXP30-YG	320728	6,890	6,610	6,240
ECXAP30-YG	320729	7,480	7,150	6,690
ECAP30-YG	320730	8,310	7,930	7,480
ECP30-YG	320731	8,460	8,040	7,580
ECSAP35-YG	320732	8,220	7,810	7,360
ECXP35-YG	320733	8,840	8,430	7,920
ECAP35-YG	320734	9,530	9,120	8,560
ECP35-YG	320735	10,390	9,830	9,270
ECXP40-YG	320736	11,520	10,980	10,320
ECP40-YG	320738	12,700	12,080	11,350
ECP45-YG	320739	13,640	12,900	12,200

#### BLACK ANODIZED

Model	Item #	1-2	3-6	7+
ECXP20-YG	320748	\$6,150	\$5,820	\$5,500
ECP20-YG	320749	6,920	6,600	6,220
ECXP25-YG	320750	6,610	6,270	5,900
ECXAP25-YG	320751	7,010	6,640	6,280
ECP25-YG	320752	8,160	7,740	7,290
ECXP30-YG	320753	7,410	7,070	6,610
ECXAP30-YG	320754	7,840	7,410	7,000
ECAP30-YG	320755	8,740	8,310	7,810
ECP30-YG	320756	9,040	8,500	8,040
ECSAP35-YG	320757	8,700	8,310	7,800
ECXP35-YG	320758	9,400	8,980	8,420
ECAP35-YG	320759	10,120	9,650	9,110
ECP35-YG	320760	10,920	10,420	9,780
ECXP40-YG	320761	12,160	11,520	10,850
ECP40-YG	320763	13,430	12,750	12,060
ECP45-YG	320764	14,380	13,690	12,900

# OUTDOOR FLAGPOLES



## ALUMINUM YARDARMS

### Cone Tapered For Single Mast Nautical Poles

Each yardarm is supplied with end pulleys, (2) lengths of solid braided polyester halyard with swivel flag snaps & snap covers, (2) 9" cast aluminum cleats with mounting screws plus all mounting hardware for a standard installation.

Model	For Pole Height	Overall Length	Center Dia.	Dia. At Ends	Shipping Weight
Y60	20'	6'	3-1/2"	2"	31 lbs.
Y65	25'	6-1/2'	3-1/2"	2"	33 lbs.
Y85	30'	8-1/2'	3-1/2"	2"	40 lbs.
Y95	35'	9-1/2'	3-1/2"	2"	43 lbs.
Y110	40'/45'	11'	3-1/2"	2"	52 lbs.

### SATIN

Model	Item #	1-2	3-6	7+
Y60	320773	\$1,460	\$1,360	\$1,290
Y65	320774	1,520	1,460	1,330
Y85	320775	1,640	1,560	1,460
Y95	320776	1,650	1,600	1,490
Y110	320777	1,810	1,740	1,640

### CLEAR ANODIZED

Model	Item #	1-2	3-6	7+
Y60	320782	\$1,770	\$1,670	\$1,590
Y65	320783	1,850	1,770	1,650
Y85	320784	2,060	1,900	1,810
Y95	320785	2,160	1,980	1,850
Y110	320786	2,320	2,220	2,110

### BRONZE ANODIZED

Model	Item #	1-2	3-6	7+
Y60	320791	\$1,780	\$1,690	\$1,640
Y65	320792	1,900	1,840	1,740
Y85	320793	2,200	2,110	1,940
Y95	320794	2,310	2,200	2,060
Y110	320795	2,560	2,430	2,280

### BLACK ANODIZED

Model	Item #	1-2	3-6	7+
Y60	320800	\$1,870	\$1,810	\$1,690
Y65	320801	2,060	1,900	1,810
Y85	320802	2,310	2,200	2,060
Y95	320803	2,390	2,280	2,170
Y110	320804	2,690	2,560	2,410



## ALUMINUM GAFFS

### Cone Tapered For Single Mast Nautical Poles

Each gaff is supplied with a cast aluminum truck, (1) length of solid braided polyester halyard with swivel flag snaps & snap covers, (1) 9" cast aluminum cleat with mounting screws plus all mounting hardware for a standard installation.

Model	For Pole Height	Overall Length	Butt Dia.	Top Dia.	Shipping Weight
G50	20'	5'	3-1/2"	2"	30 lbs.
G56	25'	5-1/2'	3-1/2"	2"	30 lbs.
G66	30'	6-1/2'	3-1/2"	2"	33 lbs.
G76	35'	7-1/2'	3-1/2"	2-3/8"	37 lbs.
G90	40'/45'	9'	3-1/2"	2-3/8"	42 lbs.

### SATIN

Model	Item #	1-2	3-6	7+
G50	320809	\$950	\$920	\$880
G56	320810	1,020	950	900
G66	320811	1,100	1,030	950
G76	320812	1,150	1,110	1,020
G90	320813	1,220	1,150	1,030

### CLEAR ANODIZED

Model	Item #	1-2	3-6	7+
G50	320818	\$1,250	\$1,180	\$1,060
G56	320819	1,330	1,300	1,210
G66	320820	1,420	1,340	1,300
G76	320821	1,490	1,460	1,340
G90	320822	1,590	1,490	1,410

### BRONZE ANODIZED

Model	Item #	1-2	3-6	7+
G50	320827	\$1,320	\$1,280	\$1,180
G56	320828	1,420	1,340	1,300
G66	320829	1,490	1,420	1,340
G76	320830	1,680	1,640	1,510
G90	320831	1,840	1,750	1,640

### BLACK ANODIZED

Model	Item #	1-2	3-6	7+
G50	320836	\$1,380	\$1,320	\$1,250
G56	320837	1,490	1,420	1,340
G66	320838	1,600	1,510	1,420
G76	320839	1,850	1,770	1,650
G90	320840	1,980	1,860	1,770

Alternative bases on this page cannot be sold separately. Must be added at time of purchase of flagpole.

## OUTDOOR FLAGPOLES

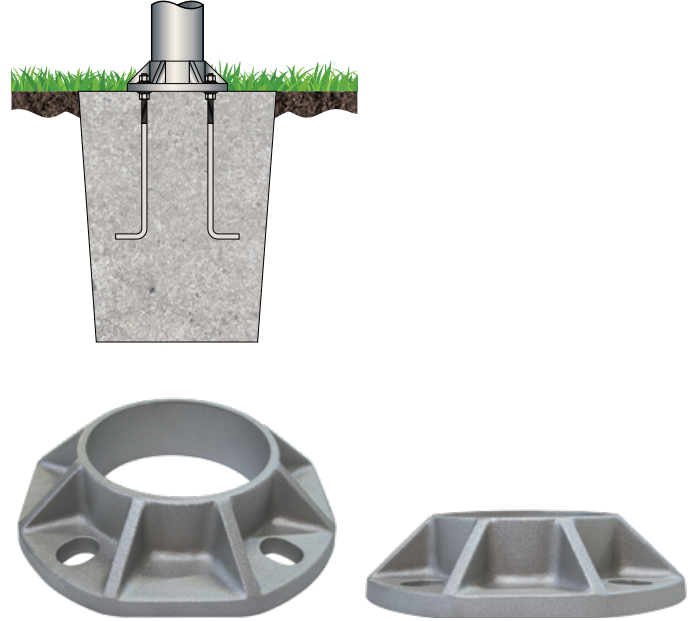
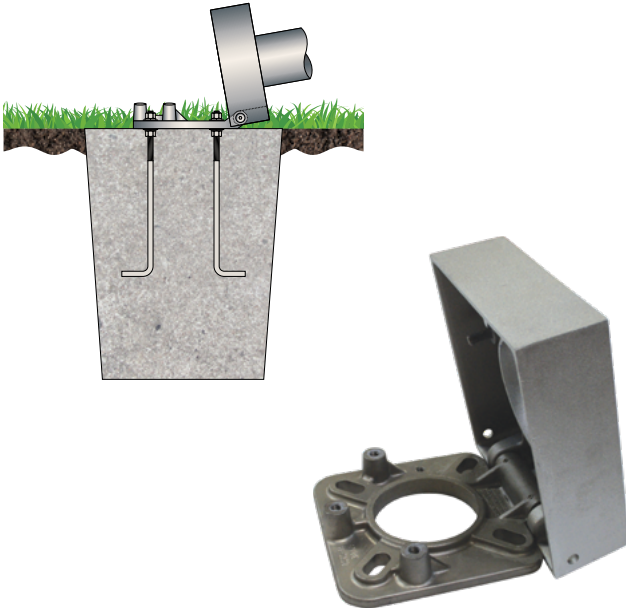

## ALTERNATIVE BASES

### TILTING SHOE BASE FLAGPOLES

All of the cone tapered aluminum flagpoles on [pages 124-137](#) with a 3", 4", 5" or 6" butt diameter can be supplied with a tilting shoe base, with the exceptions noted below. The tilting base is circumferentially welded to the base eliminating the need for a flash collar. The hinged portion of the base is held in place by (3) stainless steel, allen head bolts and pivots on a solid aluminum pivot rod. Anchor bolts are furnished for mounting to a concrete base. Not recommended for nautical poles.

- Maximum flagpole height for Tilting Shoe Base mount is 30' exposed
- Tilting Shoe Base is not available with the Hurricane Series Flagpoles
- Adding any Shoe Base mount will reduce the wind rating of the flagpole
- Shoe Base mounts are recommended for grade level mounting only

For tilting shoe base flagpoles, add the following pricing to the flagpole prices on [pages 124-137](#).

Item#	Butt Dia.	1-2	3-6	7+
323882	3"	\$860	\$840	\$770
323883	4"	1,050	980	950
323884	5"	1,070	1,040	960
323885	6"	1,070	1,040	960

### SHOE BASE FLAGPOLES

All cone tapered aluminum flagpoles up to 8" butt diameter on [pages 124-137](#) can be supplied with a shoe base mounting system. The aluminum base is circumferentially welded to the flagpole shaft. A high profile spun aluminum flash collar is supplied as standard unless otherwise specified. Anchor bolts are furnished for mounting to a concrete base. In addition to a shoe base, a mandrel is inserted into pole for added structural support.

- Adding any Shoe Base mount will reduce the wind rating of the flagpole
- Shoe Base mounts are recommended for grade level mounting only

For shoe base flagpoles, add the pricing below to the flagpole prices on [pages 124-137](#).

Item#	Butt Dia.	1-2	3-6	7+
323887	3"	\$530	\$520	\$500
323889	4"	570	550	530
323890	5"	650	590	580
323891	6"	670	650	600
323892	7"	680	670	650
323893	8"	720	710	680
-	10"	Call for pricing.		
-	12"	Call for pricing.		

If ordering three or more flagpoles that are different models, please contact a sales representative to inquire about our quantity discount.

## VERTICAL WALL MOUNT SERIES

### External Halyard Cone Tapered Aluminum Flagpoles

#### STANDARD ACCESSORIES

- Gold anodized aluminum ball ornament
- Cast aluminum revolving truck on 5" & 6" diameter poles; all others have a stationary truck as standard
- Cast aluminum cleat with mounting screws
- Solid braided polyester halyard
- Swivel flag snaps with vinyl covers
- Cast aluminum mounting brackets
- Mounting bolts with expansion shields are supplied as standard. If thru wall bolts are required, please advise length of bolt needed.

\* Flagpole models available in both one and two section styles; please specify when placing your order. Single section pole(s) will be shipped if not specified. **Add 10% to the pricing for two section style flagpoles.**

Model	Overall Length	# of Sections	Butt Dia.	Top Dia.	Wall	Rec. Flag Size	Shipping Weight
EVWM8	8'	1	2-3/8"	1-7/8"	.140	3' x 5'	31 lbs.
EVWM10	10'	1	2-3/8"	1-7/8"	.140	3' x 5'	35 lbs.
EVWM12	12'	1	2-3/8"	1-7/8"	.140	3' x 5'	38 lbs.
EVWS8	8'	1	3"	1-7/8"	.125	3' x 5'	31 lbs.
EVWS10	10'	1	3"	1-7/8"	.125	3' x 5'	34 lbs.
EVWS12	12'	1	3"	1-7/8"	.125	3' x 5'	38 lbs.
EVWS14	14'	1	3"	1-7/8"	.125	3' x 5'	42 lbs.
EVWS17	17'	1	3"	1-7/8"	.125	3' x 5'	48 lbs.
EVWS20	20'	1	3"	1-7/8"	.125	3' x 5'	53 lbs.
EVWS22	22'	1	3"	1-7/8"	.125	3' x 5'	57 lbs.
EVWS25	25'	1	3"	1-7/8"	.125	3' x 5'	63 lbs.
EVWS27	27'	1	3"	1-7/8"	.125	3' x 5'	67 lbs.
EVWAF16	16'	1	4"	2-3/8"	.125	3' x 5'	81 lbs.
EVWAF20	20'	1	4"	2-3/8"	.125	3' x 5'	94 lbs.
EVWAF22	22'	1	4"	2-3/8"	.125	3' x 5'	101 lbs.
EVWAF25	25'	1	4"	2-3/8"	.125	4' x 6'	110 lbs.
EVWAF27	27'	1	4"	2-3/8"	.125	4' x 6'	117 lbs.
EVWAF30	30'	1 or 2*	4"	2-3/8"	.125	5' x 8'	178 lbs.
LVW20	20'	1	5"	3"	.125	4' x 6'	97 lbs.
LVWC20	20'	1	5"	3"	.188	4' x 6'	99 lbs.
LVW23	23'	1	5"	3"	.125	4' x 6'	108 lbs.
LVWC23	23'	1	5"	3"	.188	4' x 6'	111 lbs.
LVW25	25'	1	5"	3"	.125	4' x 6'	115 lbs.
LVWA25	25'	1	5"	3"	.156	4' x 6'	131 lbs.
LVW27	27'	1	5"	3"	.125	4' x 6'	123 lbs.
LVWA27	27'	1	5"	3"	.156	4' x 6'	139 lbs.
LVW30	30'	1 or 2*	6"	3-1/2"	.156	5' x 8'	178 lbs.
LVWC30	30'	1 or 2*	6"	3-1/2"	.188	5' x 8'	230 lbs.
LVW33	33'	1 or 2*	6"	3-1/2"	.156	5' x 8'	192 lbs.
LVWC33	33'	1 or 2*	6"	3-1/2"	.188	5' x 8'	250 lbs.
LVW35	35'	1 or 2*	6"	3-1/2"	.156	6' x 10'	201 lbs.



Brackets for 2-3/8" Through 5" Poles



Brackets For 6" Poles

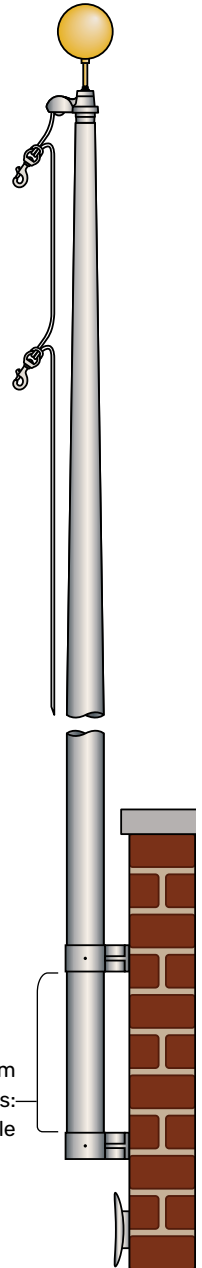

Recommended minimum spread between brackets: 10% of the length of the pole

Brackets for 7" and 8" Poles Available Upon Request

## VERTICAL WALL MOUNT SERIES

External Halyard Cone Tapered Aluminum Flagpoles

Complete Sets Including Brackets

Model	Item #	SATIN			CLEAR ANODIZED			BRONZE ANODIZED			BLACK ANODIZED					
		1-2	3-6	7+	Item #	1-2	3-6	7+	Item #	1-2	3-6	7+	Item #	1-2	3-6	7+
EVWM8	322698	\$1,110	\$1,050	\$1,010	322739	\$1,410	\$1,330	\$1,280	322780	\$1,460	\$1,380	\$1,320	322821	\$1,480	\$1,410	\$1,330
EVWM10	322699	1,150	1,100	1,020	322740	1,460	1,380	1,320	322781	1,490	1,420	1,340	322822	1,510	1,460	1,370
EVWM12	322700	1,220	1,110	1,050	322741	1,490	1,420	1,340	322782	1,590	1,490	1,410	322823	1,600	1,510	1,420
EVWS8	322705	900	870	840	322746	1,120	1,040	960	322787	1,130	1,080	970	322828	1,180	1,120	1,030
EVWS10	322706	920	880	850	322747	1,180	1,120	1,020	322788	1,250	1,130	1,040	322829	1,280	1,180	1,120
EVWS12	322707	950	920	880	322748	1,280	1,180	1,080	322789	1,300	1,210	1,120	322830	1,320	1,250	1,180
EVWS14	322708	1,050	1,020	930	322749	1,320	1,250	1,180	322790	1,340	1,300	1,210	322831	1,380	1,320	1,250
EVWS17	322709	1,150	1,050	1,020	322750	1,410	1,330	1,280	322791	1,420	1,340	1,300	322832	1,480	1,410	1,330
EVWS20	322710	1,220	1,110	1,030	322751	1,460	1,380	1,320	322792	1,570	1,480	1,380	322833	1,590	1,490	1,410
EVWS22	322711	1,290	1,230	1,150	322752	1,510	1,420	1,370	322793	1,600	1,510	1,420	322834	1,650	1,570	1,480
EVWS25	322712	1,390	1,300	1,250	322753	1,650	1,570	1,460	322794	1,680	1,640	1,510	322835	1,740	1,650	1,510
EVWS27	322713	1,430	1,360	1,290	322754	1,680	1,640	1,490	322795	1,770	1,670	1,590	322836	1,780	1,680	1,600
EVWAF16	322720	2,260	2,170	2,060	322761	2,740	2,620	2,490	322802	2,880	2,720	2,530	322843	3,040	2,880	2,690
EVWAF20	322721	2,320	2,220	2,130	322762	2,830	2,680	2,510	322803	3,010	2,830	2,620	322844	3,080	2,950	2,820
EVWAF22	322722	2,340	2,230	2,150	322763	2,900	2,730	2,530	322804	3,050	2,900	2,730	322845	3,160	3,040	2,880
EVWAF25	322723	2,440	2,330	2,220	322764	3,250	3,090	2,950	322805	3,090	3,010	2,830	322846	3,240	3,060	2,920
EVWAF27	322724	2,480	2,360	2,240	322765	3,340	3,120	3,020	322806	3,160	3,050	2,900	322847	3,340	3,120	3,020
EVWAF30	322725	2,780	2,640	2,480	322766	3,460	3,290	3,110	322807	3,530	3,360	3,180	322848	3,570	3,450	3,250
LVW20	322726	2,790	2,640	2,460	322767	3,420	3,250	3,080	322808	3,750	3,530	3,350	322849	3,920	3,730	3,450
LVWC20	322727	3,300	3,170	3,040	322768	4,070	3,850	3,610	322809	4,390	4,140	3,950	322850	4,490	4,290	4,080
LVW23	322728	2,840	2,680	2,530	322769	3,460	3,340	3,120	322810	3,830	3,550	3,370	322851	3,950	3,790	3,540
LVWC23	322729	3,350	3,190	3,060	322770	4,130	3,950	3,720	322811	4,450	4,190	4,020	322852	4,510	4,200	4,050
LVW25	322730	2,890	2,770	2,580	322771	3,730	3,460	3,320	322812	3,940	3,770	3,520	322853	4,000	3,840	3,570
LVWA25	322731	3,280	3,100	2,970	322772	4,050	3,920	3,730	322813	4,140	3,950	3,770	322854	4,410	4,200	4,000
LVW27	322732	2,980	2,790	2,630	322773	3,750	3,530	3,350	322814	3,960	3,810	3,550	322855	4,030	3,900	3,630
LVWA27	322733	3,320	3,150	3,000	322774	4,140	3,950	3,750	322815	4,200	4,000	3,830	322856	4,490	4,280	4,030
LVW30	322734	4,190	3,950	3,770	322775	5,230	4,960	4,730	322816	5,340	5,040	4,830	322857	5,450	5,230	4,930
LVWC30	322735	4,560	4,340	4,060	322776	5,500	5,240	4,970	322817	5,570	5,330	5,030	322858	5,810	5,500	5,230
LVW33	322736	4,280	4,070	3,880	322777	5,300	5,000	4,780	322818	5,420	5,200	4,910	322859	5,560	5,320	5,000
LVWC33	322737	4,520	4,300	4,070	322778	5,570	5,330	5,030	322819	5,600	5,360	5,110	322860	5,900	5,560	5,280
LVW35	322738	4,290	4,080	3,890	322779	5,400	5,120	4,890	322820	5,540	5,300	4,960	322861	5,670	5,390	5,110

### BRACKETS ONLY

\*Satin brackets can be used with both Satin and Clear Anodized poles

For Pole Butt Dia.	Model	Lbs	SATIN*			BRONZE			BLACK					
			Item #	1-2	3-6	7+	Item #	1-2	3-6	7+	Item #	1-2	3-6	7+
2-3/8"	EVWM/B	4.1	323026	\$290	\$280	\$240	323040	\$345	\$330	\$320	323047	\$345	\$330	\$320
3"	EVWS/B	7.7	323027	290	280	240	323041	345	330	320	323048	345	330	320
4"	EVWAF/B	20	323029	800	730	710	323043	900	870	840	323050	900	870	840
5"	LVW/B	14	323030	800	730	710	323044	900	870	840	323051	900	870	840
6"	LVW6/B	25	323031	1,210	1,130	1,060	323045	1,280	1,240	1,180	323052	1,280	1,240	1,180

Brackets only do not include mounting hardware. Mounting hardware priced separately on [page 174](#).

If ordering three or more flagpoles that are different models, please contact a sales representative to inquire about our quantity discount.

## OUTRIGGER WALL MOUNT SERIES

### External Halyard Aluminum Flagpoles

#### STANDARD ACCESSORIES

- Gold anodized aluminum ball ornament
- Cast aluminum stationary truck
- Solid braided polyester halyard
- Swivel flag snaps with vinyl covers
- Cast aluminum cleat with mounting screws
- Cast aluminum mounting bracket
- Mounting bolts with expansion shields are supplied as standard.  
If thru wall bolts are required, please advise length of bolt needed.

Mounting holes depicted are representations only and do not show actual bolt patterns. Templates are available upon request. Mounting back plate not included.

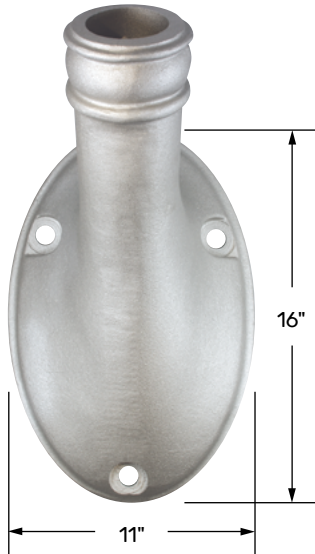
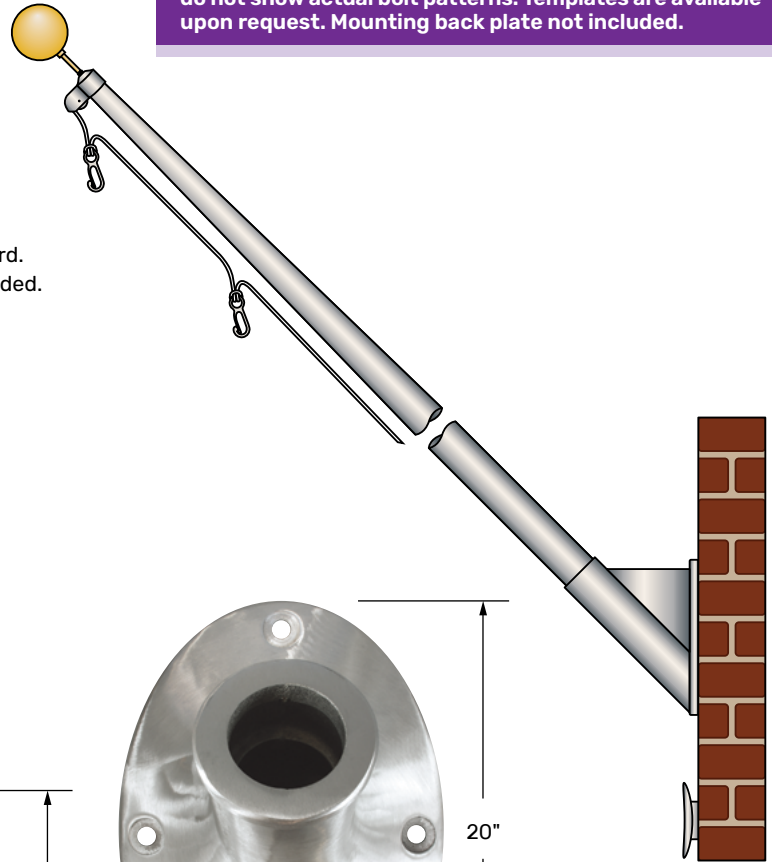

**ECOM**  
2-3/8" Butt Diameter  
Poles Only  
45° Angle

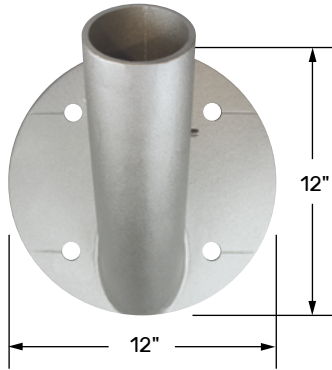

**ECOST & ECOS**  
3" Butt Diameter  
Poles Only  
45° Angle



**ECO**  
3-1/2" Butt Diameter  
Poles Only  
60° Angle

All Models are Cone Tapered Except the ECOS Models which are Non-Tapering Poles

Model	Overall Length	Cone Tapered	Non-Tapered	Butt Dia.	Top Dia.	Wall	Suggested Flag Size	Shipping Weight
ECOM8	8'	•		2-3/8"	1-7/8"	.140	3' x 5'	51 lbs.
ECOM10	10'	•		2-3/8"	1-7/8"	.140	3' x 5'	58 lbs.
ECOM12	12'	•		2-3/8"	1-7/8"	.140	3' x 5'	58 lbs.
ECOST8	8'	•		3"	1-7/8"	.125	3' x 5'	36 lbs.
ECOST10	10'	•		3"	1-7/8"	.125	3' x 5'	39 lbs.
ECOS8	8'		•	3"	3"	.125	3' x 5'	35 lbs.
ECOS10	10'		•	3"	3"	.125	3' x 5'	38 lbs.
ECO8	8'	•		3-1/2"	2-3/8"	.125	3' x 5'	54 lbs.
ECO10	10'	•		3-1/2"	2-3/8"	.125	3' x 5'	58 lbs.
ECO12	12'	•		3-1/2"	2-3/8"	.125	3' x 5'	62 lbs.

## OUTRIGGER WALL MOUNT SERIES

### External Halyard Aluminum Flagpoles

Outrigger complete sets include bracket & mounting hardware.

#### SATIN COMPLETE SETS

Model	Item #	1-2	3-6	7+
ECOM8	323061	\$1,610	\$1,570	\$1,470
ECOM10	323062	1,650	1,600	1,470
ECOM12	323063	1,700	1,610	1,490
ECOST8	323066	960	930	910
ECOST10	323067	950	930	900
ECOS8	323068	920	880	840
ECOS10	323069	930	900	870
ECO8	324061	2,330	2,230	2,140
ECO10	324057	2,340	2,260	2,160
ECO12	323070	2,430	2,270	2,170

#### CLEAR ANODIZED COMPLETE SETS

Model	Item #	1-2	3-6	7+
ECOM8	323073	\$2,060	\$1,940	\$1,840
ECOM10	323074	2,080	1,960	1,850
ECOM12	323075	2,110	2,000	1,860
ECOST8	323078	1,290	1,230	1,170
ECOST10	323079	1,320	1,280	1,190
ECOS8	323080	1,060	1,020	960
ECOS10	323081	1,180	1,080	1,040
ECO8	324062	3,110	3,020	2,830
ECO10	324058	3,160	3,050	2,880
ECO12	323082	3,210	3,060	2,910

#### BRONZE ANODIZED COMPLETE SETS

Model	Item #	1-2	3-6	7+
ECOM8	323085	\$2,360	\$2,260	\$2,150
ECOM10	323086	2,390	2,280	2,170
ECOM12	323087	2,430	2,320	2,210
ECOST8	323090	1,330	1,260	1,170
ECOST10	323091	1,340	1,320	1,240
ECOS8	323092	1,130	1,060	970
ECOS10	323093	1,210	1,180	1,080
ECO8	324063	3,200	3,060	2,900
ECO10	324059	3,240	3,090	2,920
ECO12	323094	3,260	3,110	3,010

#### BLACK ANODIZED COMPLETE SETS

Model	Item #	1-2	3-6	7+
ECOM8	323097	\$2,370	\$2,270	\$2,170
ECOM10	323098	2,410	2,320	2,210
ECOM12	323099	2,490	2,370	2,260
ECOST8	323102	1,420	1,370	1,290
ECOST10	323103	1,380	1,340	1,320
ECOS8	323104	1,210	1,180	1,060
ECOS10	323105	1,280	1,210	1,130
ECO8	324064	3,260	3,110	2,950
ECO10	324060	3,320	3,160	3,020
ECO12	323106	3,340	3,160	3,010

#### SATIN BRACKET ONLY

\* Satin brackets can be used with both Satin and Clear Anodized poles

Model	Item #	1-2	3-6	7+	Lbs.
ECOM/B	323157	\$920	\$900	\$860	26
ECOST/B	323158	540	530	480	8.4
ECO/B	323159	1,840	1,740	1,650	22

#### BRONZE BRACKET ONLY

Model	Item #	1-2	3-6	7+	Lbs.
ECOM/B	323163	\$1,250	\$1,180	\$1,120	26
ECOST/B	323164	620	600	570	8.4
ECO/B	323165	2,080	1,940	1,840	22

#### BLACK BRACKET ONLY

Model	Item #	1-2	3-6	7+	Lbs.
ECOM/B	323166	\$1,250	\$1,180	\$1,120	26
ECOST/B	323167	620	600	570	8.4
ECO/B	323168	2,080	1,940	1,840	22



ECOM



ECOST & ECOS



ECO

Brackets only do not include mounting hardware. Mounting hardware priced separately on [page 174](#).

# OUTDOOR FLAGPOLES

## FRANKLIN SERIES

The Franklin series comes complete with 1-1/2" diameter clear anodized aluminum pole, 3" gold anodized aluminum ball ornament, cast aluminum single-sheave stationary truck, 50' of 1/4" solid braided polyester halyard, (2) nylon flag snaps per halyard, 9" cast aluminum cleat(s) with mounting screws and cast aluminum mounting bracket(s). Mounting hardware not included.



### OUTRIGGER SETS

With bracket

Model	Item #	Len.	1-2	3-6	7+	Lbs.
EOA6	323403	6'	\$630	\$600	\$560	14
EOA9	323404	9'	690	680	640	17
EOA10	323405	10'	710	690	680	18

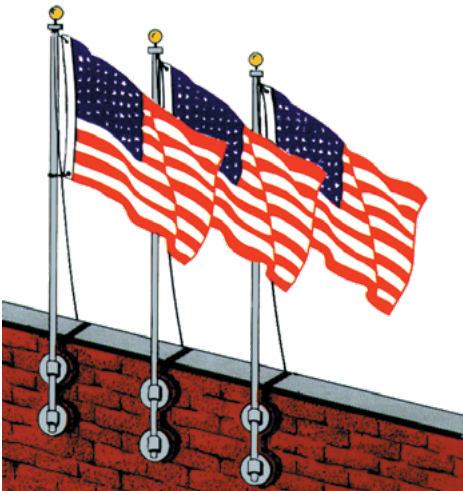

### VERTICAL WALL SETS

With brackets

Model	Item #	Len.	1-2	3-6	7+	Lbs.
EVWA6	323415	6'	\$590	\$560	\$520	13
EVWA9	323416	9'	650	640	630	16
EVWA10	323417	10'	690	680	640	17
EVWA12	323418	12'	710	690	650	19

### CLEAR ANODIZED POLES ONLY

Item #	Diameter	Length	Wall	Price	Lbs.
310039	1-1/2"	72"	.125	\$89	3.7
323739	1-1/2"	96"	.125	129	4.6
323427	1-1/2"	108"	.125	140	5.6
323428	1-1/2"	120"	.125	156	6.2
323429	1-1/2"	144"	.125	189	7.4



### OUTRIGGER BRACKET

- Displays pole at 30° angle
- Mounting hardware not included

Model	Item #	1-2	3-6	7+	Lbs.
EOA	323422	\$218	\$216	\$214	3.4



### VERTICAL WALL BRACKETS

- Mounting hardware not included
- Priced per set of top & bottom bracket

Model	Item #	1-2	3-6	7+	Lbs.
EVWA	323426	\$211	\$197	\$183	2.2



Gold



Clear



Satin



Bronze



Black



White

ALUMINUM BALL ORNAMENTS

Model	Dia.	Spindle Threading	Lbs.	Gold Anodized			Clear Anodized			Satin		
				Item #	1-5	6+	Item #	1-5	6+	Item #	1-5	6+
SB102	2"	1/2"-13NC	.16	330089	\$29	\$24	-	-	-	-	-	-
SB103	3"	1/2"-13NC	.30	330000	43	38	330007	\$55	\$54	330082	\$53	\$51
SB104	4"	1/2"-13NC	.45	330001	54	52	330008	72	66	330083	64	61
SB105	5"	1/2"-13NC	.60	330002	63	57	330009	83	77	330084	69	64
SB106	6"	1/2"-13NC	.80	330003	79	70	330010	117	105	330085	92	82
SB108	8"	1/2"-13NC	1.4	330004	142	131	330011	179	162	330086	146	138
SB110	10"	5/8"-11NC	2.2	330005	250	224	-	-	-	330087	238	229
SB112	12"	5/8"-11NC	3.1	330006	318	292	330013	323	292	330088	281	277

Model	Dia.	Spindle Threading	Lbs.	Bronze			Black			White		
				Item #	1-5	6+	Item #	1-5	6+	Item #	1-5	6+
SB103	3"	1/2"-13NC	.30	330014	\$54	\$51	330021	\$54	\$51	330028	\$54	\$51
SB104	4"	1/2"-13NC	.45	330015	68	62	330022	68	62	330029	68	62
SB105	5"	1/2"-13NC	.60	330016	80	77	330023	80	77	330030	80	77
SB106	6"	1/2"-13NC	.80	330017	109	98	330024	109	98	330031	109	98
SB108	8"	1/2"-13NC	1.4	330018	170	153	330025	170	153	330032	170	153
SB110	10"	5/8"-11NC	2.2	330019	309	280	330026	309	280	330033	309	280
SB112	12"	5/8"-11NC	3.1	330020	381	345	330027	381	345	330034	381	345

COPPER BALL ORNAMENTS

Model	Item #	Dia.	Spindle Threading	1-5	6+	Lbs.
CB104	330091	4"	1/2"-13NC	\$254	\$242	1.5
CB105	330092	5"	1/2"-13NC	318	302	2.0
CB106	330093	6"	1/2"-13NC	380	362	2.5
CB108	330094	8"	5/8"-11NC	501	479	4.1
CB110	330095	10"	5/8"-11NC	737	701	4.9
CB112	330096	12"	5/8"-11NC	1,242	1,180	6.5



GOLD LEAF COPPER BALL ORNAMENTS

Model	Item #	Dia.	Spindle Threading	1-5	6+	Lbs.
GL104	330047	4"	1/2"-13NC	\$402	\$362	1.5
GL105	330048	5"	1/2"-13NC	473	448	2.0
GL106	330049	6"	1/2"-13NC	578	552	2.6
GL108	330050	8"	5/8"-11NC	1,055	1,006	4.2
GL110	330051	10"	5/8"-11NC	1,570	1,503	7.7
GL112	330052	12"	5/8"-11NC	2,311	2,198	8.1



# OUTDOOR FLAGPOLE ACCESSORIES

ORNAMENTS

## STAINLESS STEEL BALL ORNAMENTS

Model	Dia.	Spindle Threading	Lbs.	Item #	Satin Finish		Mirror Finish		
					1-5	6+	Item #	1-5	6+
SS104	4"	1/2"-13NC	1.5	330035	\$311	\$284	330041	\$376	\$338
SS105	5"	1/2"-13NC	2.0	330036	382	348	330042	446	399
SS106	6"	1/2"-13NC	2.5	330037	395	358	330043	477	420
SS108	8"	1/2"-13NC	4.1	330038	497	449	-	-	-
SS110	10"	5/8"-11NC	6.1	330039	689	621	330045	802	720
SS112	12"	5/8"-11NC	7.8	330040	845	765	330046	940	860



Satin



Mirror

## NATURAL ALUMINUM FLYING EAGLES



Model	Wing Span	Height	Spindle Threading	Lbs.	Item #	1-5	6+
						\$	\$
E-9	8-1/2"	15"	1/2"-13NC	2.4	330099	\$222	\$206
E-14	14"	20"	1/2"-13NC	5.5	330100	315	291



E-9



E-11



E-14

## GOLD ALUMINUM FLYING EAGLES

Model	Wing Span	Height	Spindle Threading	Lbs.	Item #	1-5	6+
						\$	\$
E-11	11-1/4"	12"	1/2"-13NC	2.7	330055	\$182	\$172
E-16	15"	18"	1/2"-13NC	5.4	330056	229	214
E-24	24"	10"	1/2"-13NC	6.4	330057	400	364



E-16



E-24



## GOLD ANODIZED ALUMINUM GLOBE

Can be used with the following eagles: E-9 Natural; E-14 Natural; E-16 Gold.

Item #	Diameter	Price	Lbs.
330090	3"	\$29.20	.07

## METAL EAGLE ORNAMENTS

Gold powder coated painted finish

Model	Item #	Wing Span	Ht.	Spindle Threading	Price	Lbs.
E-8PC	050538	8-1/4"	7"	1/2"-13NC	\$64.00	1.4
E-9PC	330098	9-1/4"	7-1/4"	1/2"-13NC	112.00	2.0
E-12PC	330097	12"	8-1/2"	1/2"-13NC	118.00	3.3



## PLAIN ALUMINUM CROSSES

Gold powder coated painted finish

Model	Item #	Cross Ht.	Cross Width	Spindle Threading	1-5	6+	Lbs.
					\$	\$	
PC8	330078	8-1/2"	4-1/4"	1/2"-13NC	\$167	\$153	1.3
PC12	330079	13"	6-3/4"	1/2"-13NC	231	214	1.7



## ALUMINUM BOTONÉE CROSS

Gold powder coated painted finish

Model	Item #	Cross Ht.	Cross Width	Spindle Threading	1-5	6+	Lbs.
					\$	\$	
BC12	330081	12"	12"	5/8"-11NC	\$277	\$249	6.8





**ST-1 SERIES**

- For external halyard poles
- Cap style
- Stationary
- Single pulley
- **Construction:** cast aluminum
- **Pulley:** 1" outside diameter nylon on 3/16" stainless steel axle
- **Max halyard diameter:** 1/4"
- **Truck:** secured by 1 stainless steel set screw (size 1/4"-20NC)
- **Ornaments:** accepts spindle threading of 1/2"-13NC. Secured by 1 stainless steel pan head screw (size 10-32). **Can be supplied with 5/8" threading size for use with 5/8" ornaments.**

Model	Fits Pole Diameter	Lbs.	Silver			Bronze			White			Black		
			Item #	1-5	6+	Item #	1-5	6+	Item #	1-5	6+	Item #	1-5	6+
ST-1-38	1-3/8"	1.0	340000	\$45.50	\$42.00	340005	\$52.00	\$46.50	340010	\$52.00	\$46.50	340015	\$52.00	\$46.50
ST-1-12	1-1/2"	1.0	340001	45.50	42.00	340006	52.00	46.50	340011	52.00	46.50	340016	52.00	46.50
ST-1-34	1-3/4"	.90	340002	45.50	42.00	340007	52.00	46.50	340012	52.00	46.50	340017	52.00	46.50
ST-1-16	1-15/16"	.80	340003	45.50	42.00	340008	52.00	46.50	340013	52.00	46.50	340018	52.00	46.50
ST-1-20	2"	.80	340004	45.50	42.00	340009	52.00	46.50	340014	52.00	46.50	340019	52.00	46.50



**ST-32 SERIES**

- For external halyard poles
- Cap style
- Stationary
- Double pulley
- **Construction:** cast aluminum
- **Pulleys:** 1-1/2" outside diameter nylon on 1/4" stainless steel axles
- **Max halyard diameter:** 5/16"
- **Truck:** secured by 3 stainless steel set screws (size 5/16"-18NC)
- **Ornaments:** accepts spindle threading of 1/2"-13NC. Secured by 1 stainless steel set screw (1/4"-20NC). **Can be supplied with 5/8" threading size for use with 5/8" ornaments.**

Model	Fits Pole Diameter	Lbs.	Silver			Bronze			White			Black		
			ITEM #	1-5	6+	ITEM #	1-5	6+	ITEM #	1-5	6+	ITEM #	1-5	6+
ST-3	1-7/8"	1.9	340040	\$92	\$84	340042	\$99	\$92	340044	\$99	\$92	340046	\$99	\$92
ST-2	2-3/8"	1.7	340041	92	84	340043	99	92	340045	99	92	340047	99	92



**RTC-1 SERIES**

- For external halyard poles
- Cap style
- Revolving
- Single pulley
- **Construction:** cast aluminum
- **Pulley:** 1-1/2" outside diameter nylon on 1/4" stainless steel axle
- **Max halyard diameter:** 5/16"
- **Truck:** secured by 3 stainless steel set screws (1/4"-20NC on RTC-1-2, RTC-1-138; 5/16"-18NC on RTC-1-238)
- **Ornaments:** accepts spindle threading of 1/2"-13NC. Secured by 1 stainless steel set screw (1/4"-20NC). **Can be supplied with 5/8" threading size for use with 5/8" ornaments.**
- **Movement:** utilizes stainless steel ball bearing assemblies for ease of rotation, product life, and strength

Model	Fits Pole Diameter	Lbs.	Silver			Bronze			White			Black		
			Item #	1-5	6+	Item #	1-5	6+	Item #	1-5	6+	Item #	1-5	6+
RTC-1-138	1-3/8"	1.8	340351	\$158	\$141	340308	\$175	\$156	340309	\$175	\$156	340352	\$175	\$156
RTC-1-2	2"	1.6	340104	158	141	340106	175	156	340108	175	156	340110	175	156
RTC-1-238	2-3/8"	1.9	340105	158	141	340107	175	156	340109	175	156	340111	175	156

# OUTDOOR FLAGPOLE ACCESSORIES



## OT SERIES

- For external halyard poles
- Cap style
- Stationary
- Single pulley
- **Construction:** cast aluminum
- **Pulley:** nylon on 1/4" stainless steel axle (1-1/2" outside diameter on OTH, OT1, OT25, OT35; 2" on OT2, OT3, OT325)
- **Max halyard diameter:** 5/16"
- **Truck:** secured by stainless steel set screws (one 1/4"-20NC on OTH and OT178; three 5/16"-18NC on OT1, OT2, OT25, OT3, OT325, OT35)
- **Ornaments:** accepts spindle threading of 1/2"-13NC. Secured by 1 stainless steel pan head screw (size 10-32). **Can be supplied with 5/8" threading size for use with 5/8" ornaments.**

Model	Fits Pole Diameter	Lbs.	Silver			Bronze			White			Black		
			Item #	1-5	6+	Item #	1-5	6+	Item #	1-5	6+	Item #	1-5	6+
OT178	1-7/8"	.60	340364	\$42.00	\$39.50	340365	\$46.50	\$43.00	340366	\$46.50	\$43.00	340367	\$46.50	\$43.00
OTH	2"	.55	340056	42.00	39.50	340062	46.50	43.00	340068	46.50	43.00	340074	46.50	43.00
OT1	2-3/8"	.95	340057	58.50	46.50	340063	63.00	59.00	340069	63.00	59.00	340075	63.00	59.00
OT25	2-1/2"	.95	340058	60.50	52.00	340064	70.00	61.00	340070	70.00	61.00	340076	70.00	61.00
OT2	2-3/4"	1.5	340059	64.50	57.00	340065	74.00	63.00	340071	74.00	63.00	340077	74.00	63.00
OT3	3"	1.3	340060	72.00	60.50	340066	79.00	70.00	340072	79.00	70.00	340078	79.00	70.00
OT325	3-1/4"	1.2	340343	74.00	62.00	340344	82.00	79.00	340345	82.00	79.00	340346	82.00	79.00
OT35	3-1/2"	1.8	340061	78.00	73.00	340067	84.00	80.00	340073	84.00	80.00	340079	84.00	80.00

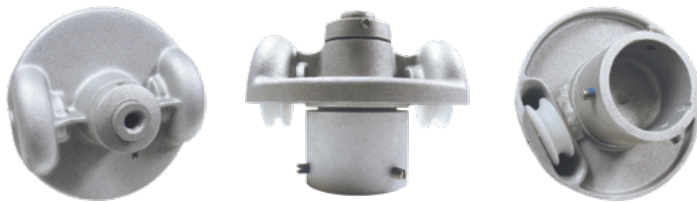

## RTC-2 SERIES

- For external halyard poles
- Cap style
- Revolving
- Double pulley
- **Construction:** cast aluminum
- **Pulley:** 1-15/16" outside diameter nylon on 1/4" stainless steel axles
- **Max halyard diameter:** 5/16"
- **Truck:** secured by 3 stainless steel set screws (1/4"-20NC on RTC-2-2, RTC-2-138; 5/16"-18NC on RTC-2-238)
- **Ornaments:** accepts spindle threading of 1/2"-13NC. Secured by 1 stainless steel set screw (1/4"-20NC). **Can be supplied with 5/8" threading size for use with 5/8" ornaments.**
- **Movement:** utilizes stainless steel ball bearing assemblies for ease of rotation, product life, and strength

Model	Fits Pole Diameter	Lbs.	Silver			Bronze			White			Black		
			Item #	1-5	6+	Item #	1-5	6+	Item #	1-5	6+	Item #	1-5	6+
RTC-2-138	1-3/8"	2.5	340353	\$158	\$141	340310	\$175	\$156	340311	\$175	\$156	340354	\$175	\$156
RTC-2-2	2"	2.3	340120	158	141	340122	175	156	340124	175	156	340126	175	156
RTC-2-238	2-3/8"	2.6	340121	158	141	340123	175	156	340125	175	156	340127	175	156



**RTS-1 SERIES**

- For external halyard poles
- Threaded
- Revolving
- Single pulley
- **Construction:** cast aluminum
- **Pulley:** 1-1/2" outside diameter nylon on 1/4" stainless steel axle
- **Max halyard diameter:** 5/16"
- **Truck Spindle:** 1-1/4" NPT threading
- **Flagpole:** For up to 3-1/2" outside top diameter pole with female fitting installed
- **Ornaments:** accepts spindle threading of 1/2"-13NC. Secured by 1 stainless steel set screw (1/4"-20NC). **Can be supplied** with 5/8" threading size for use with 5/8" ornaments.
- **Movement:** utilizes stainless steel ball bearing assemblies for ease of rotation, product life, and strength

Model	Fits Pole Diameter	Lbs.	Silver			Bronze			White			Black		
			Item #	1-5	6+	Item #	1-5	6+	Item #	1-5	6+	Item #	1-5	6+
RTS-1-125	3-1/2"	1.9	340136	\$129	\$117	340137	\$141	\$129	340138	\$141	\$129	340139	\$141	\$129



**RTA-1 SERIES**

- For external halyard poles
- Threaded
- Revolving
- Single pulley
- **Construction:** cast aluminum
- **Pulley:** 1-1/2" outside diameter machined aluminum on 1/4" stainless steel axle
- **Max halyard diameter:** 5/16"
- **Truck Spindle:** 1-1/4" NPT threading
- **Flagpole:** For up to 3-1/2" outside top diameter pole with female fitting installed
- **Ornaments:** accepts spindle threading of 1/2"-13NC. Secured by 1 stainless steel set screw (1/4"-20NC). **Can be supplied** with 5/8" threading size for use with 5/8" ornaments.
- **Movement:** utilizes stainless steel ball bearing assemblies for ease of rotation, product life, and strength

Model	Fits Pole Diameter	Lbs.	Silver			Bronze			White			Black		
			Item #	1-5	6+	Item #	1-5	6+	Item #	1-5	6+	Item #	1-5	6+
RTA-1-125	3-1/2"	2.0	340360	\$145	\$132	340361	\$155	\$145	340362	\$155	\$145	340363	\$155	\$145



**RTS-2 SERIES**

- For external halyard poles
- Threaded
- Revolving
- Double pulley
- **Construction:** cast aluminum
- **Pulley:** 1-15/16" outside diameter nylon on 1/4" stainless steel axles
- **Max halyard diameter:** 5/16"
- **Truck Spindle:** 1-1/4" NPT threading
- **Flagpole:** For up to 3-1/2" outside top diameter pole with female fitting installed
- **Ornaments:** accepts spindle threading of 1/2"-13NC. Secured by 1 stainless steel set screw (1/4"-20NC). **Can be supplied** with 5/8" threading size for use with 5/8" ornaments.
- **Movement:** utilizes stainless steel ball bearing assemblies for ease of rotation, product life, and strength

Model	Fits Pole Diameter	Lbs.	Silver			Bronze			White			Black		
			Item #	1-5	6+	Item #	1-5	6+	Item #	1-5	6+	Item #	1-5	6+
RTS-2-125	3-1/2"	2.6	340144	\$141	\$129	340145	\$147	\$134	340146	\$147	\$134	340147	\$147	\$134

# OUTDOOR FLAGPOLE ACCESSORIES



## HDT-1 SERIES

- For external halyard poles
- Threaded
- Revolving
- Single pulley
- **Construction:** cast aluminum
- **Pulley:** 2-1/2" outside diameter cast aluminum on 1/2" stainless steel axle
- **Max halyard diameter:** 3/8"
- **Truck Spindle:** 1-1/4" NPT threading
- **Flagpole:** up to 6" outside top diameter pole with female fitting installed
- **Ornaments:** accepts spindle threading of 1/2"-13NC. Secured by 1 stainless steel set screw (1/4"-20NC). **Can be supplied with 5/8" threading size for use with 5/8" ornaments.**
- **Movement:** utilizes enclosed stainless steel bearings and raceway

Model	Fits Pole Diameter	Lbs.	Silver			Bronze			White			Black		
			Item #	1-5	6+	Item #	1-5	6+	Item #	1-5	6+	Item #	1-5	6+
HDT-1	6"	4.8	340335	\$298	\$271	340336	\$323	\$292	340337	\$323	\$292	340338	\$323	\$292



## HDT-2 SERIES

- For external halyard poles
- Threaded
- Revolving
- Double pulley
- **Construction:** cast aluminum
- **Pulley:** 3-3/4" outside diameter cast aluminum on 1/2" stainless steel axles
- **Max halyard diameter:** 3/8"
- **Truck Spindle:** 1-1/4" NPT threading
- **Flagpole:** up to 5-1/2" outside top diameter pole with female fitting installed
- **Ornaments:** accepts spindle threading of 1/2"-13NC. Secured by 1 stainless steel set screw (1/4"-20NC). **Can be supplied with 5/8" threading size for use with 5/8" ornaments.**
- **Movement:** utilizes enclosed stainless steel bearings and raceway

Model	Fits Pole Diameter	Lbs.	Silver			Bronze			White			Black		
			Item #	1-5	6+	Item #	1-5	6+	Item #	1-5	6+	Item #	1-5	6+
HDT-2	5-1/2"	5.1	340152	\$340	\$309	340153	\$368	\$333	340154	\$368	\$333	340155	\$368	\$333



## EXTRA HEAVY-DUTY SERIES

- For external halyard poles
- Threaded
- Revolving
- Double pulley
- **Construction:** cast aluminum
- **Pulleys:** 3-7/8" outside diameter cast aluminum on 1/2" stainless steel axles
- **Max halyard diameter:** 3/8"
- **Truck Spindle:** 1-1/4" NPT threading
- **Flagpole:** For up to 8" outside top diameter pole with female fitting installed
- **Ornaments:** accepts spindle threading of 1/2"-13NC. Secured by 1 stainless steel set screw (1/4"-20NC). **Can be supplied with 5/8" threading size for use with 5/8" ornaments.**
- **Movement:** utilizes stainless steel sealed ball bearing assemblies for ease of rotation, product life and strength

Model	Spindle Material	Lbs.	Silver			Bronze			White			Black		
			Item #	1-5	6+	Item #	1-5	6+	Item #	1-5	6+	Item #	1-5	6+
XHDT	Aluminum	9.7	340160	\$1,255	\$1,130	340162	\$1,330	\$1,195	340164	\$1,330	\$1,195	340166	\$1,330	\$1,195
XHDT-SS	Stainless Steel	12	340161	2,415	2,165	340163	2,455	2,200	340165	2,455	2,200	340167	2,455	2,200



**IH-1 SERIES**

- For rope style internal halyard poles
- Cap style
- Stationary
- Single pulley
- **Construction:** cast aluminum
- **Internal Pulley:** 1-1/2" outside diameter nylon on 1/4" stainless steel axle. Pulley assembly affixed to inside of truck by 5/16"-18NC stainless steel set screw
- **External pulley:** cast nylon on 1/4" stainless steel axle (2" outside diameter on IH-1-3; 1-1/2" on IH-1-35)
- **Max halyard diameter:** 5/16"
- **Truck:** secured by 3 stainless steel set screws (size 5/16"-18NC)
- **Ornaments:** accepts spindle threading of 1/2"-13NC. Secured by 1 stainless steel pan head screw (size 10-32). **Can be supplied with 5/8" threading size for use with 5/8" ornaments.**

Model	Fits Pole Diameter	Lbs.	Silver			Bronze			White			Black		
			Item #	1-5	6+	Item #	1-5	6+	Item #	1-5	6+	Item #	1-5	6+
IH-1-3	3"	1.6	340178	\$107	\$98	340180	\$121	\$107	340182	\$121	\$107	340184	\$121	\$107
IH-1-35	3-1/2"	2.3	340179	142	131	340181	165	145	340183	165	145	340185	165	145



**IH-2 SERIES**

- For cable or rope style internal halyard poles
- Threaded
- Revolving
- Single pulley
- **Construction:** cast aluminum
- **Cable Bushing:** IHT-3 has a bronze fitting; all other sizes supplied with a stainless steel bushing at the cable exit point
- **Truck Spindle:** 1-1/4" NPT threading
- **Ornaments:** accepts spindle threading of 1/2"-13NC. Secured by 1 stainless steel set screw (1/4"-20NC). **Can be supplied with 5/8" threading size for use with 5/8" ornaments.**
- **Movement:** IHT-3 utilizes stainless steel sealed bearing assemblies; all other sizes utilize enclosed stainless steel bearings and raceway.

Model	Truck Base Dia.	Truck Ht.	Max. Pole Top Dia.	Lbs.	Silver			Bronze			White			Black		
					Item #	1-5	6+	Item #	1-5	6+	Item #	1-5	6+	Item #	1-5	6+
IHT-VR	5"	4-1/2"	3"	4.3	340194	\$375	\$341	340198	\$413	\$375	340206	\$413	\$375	340202	\$413	\$375
IHT-1	6-1/2"	6-1/2"	4"	6.4	340195	563	504	340199	611	551	340207	611	551	340203	611	551
IHT-2	7-1/2"	7-1/4"	5"	8.7	340196	678	610	340200	738	663	340208	738	663	340204	738	663
IHT-3	10-1/2"	8-1/2"	7-1/2"	13.6	340197	1,393	1,253	340201	1,545	1,387	340209	1,545	1,387	340205	1,545	1,387

# OUTDOOR FLAGPOLE ACCESSORIES

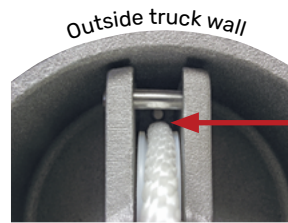

Recommended:  
Thread halyard to inside of  
halyard pin stop as shown.

## IHT-VS SERIES

- For rope style internal halyard poles
- Threaded
- Stationary
- Single pulley
- **Construction:** cast aluminum
- **Internal pulley:** 2" outside diameter cast nylon on 1/4" stainless steel axle. Pulley assembly affixed to inside of truck.
- **Max halyard diameter:** 5/16"
- **Truck spindle:** 1-1/4" NPT threading
- **Flagpole:** For up to 3-1/2" outside top diameter pole with female fitting installed
- **Ornaments:** accepts spindle threading of 1/2"-13NC. Secured by 1 stainless steel set screw (1/4"-20NC). **Can be supplied with 5/8" threading size for use with 5/8" ornaments.**

Model	Fits Pole Diameter	Lbs.	Silver		Bronze		White		Black					
			Item #	1-5	6+	Item #	1-5	6+	Item #	1-5	6+			
IHT-VS	3-1/2"	2.4	340312	\$147	\$134	340313	\$166	\$147	340314	\$166	\$147	340315	\$166	\$147



## 150 SERIES

- For external halyard poles
- Threaded
- Revolving
- Double pulley
- **Construction:** cast aluminum
- **Pulleys:** 1-15/16" outside diameter nylon on 1/4" stainless steel axles
- **Max halyard diameter:** 5/16"
- **Truck spindle:** 1-1/2" NPT threading
- **Flagpole:** for up to 4" outside top diameter pole with female fitting installed
- **Ornaments:** accepts spindle threading of 1/2"-13NC. Secured by 1 stainless steel set screw (1/4"-20NC). **Can be supplied with 5/8" threading size for use with 5/8" ornaments.**
- **Movement:** utilizes stainless steel ball bearing assemblies for ease of rotation, product life, and strength

Model	Fits Pole Diameter	Lbs.	Silver		Bronze		White		Black					
			Item #	1-5	6+	Item #	1-5	6+	Item #	1-5	6+			
RTS-2-150	4"	2.6	340170	\$237	\$214	340171	\$269	\$237	340172	\$269	\$237	340173	\$269	\$237

## POLE TOP ADAPTERS

These adapters are used when mounting a truck that has a spindle threading of 1-1/4" NPT and the pole does not have a threaded top plug installed. The adapter is tapped 1-1/4" NPT and is designed to slip over the top of the pole and is secured by three 1/4"-20NC stainless steel set screws. Please specify color when ordering. If not specified, silver will be supplied.



Model	Fits Pole Diameter	Lbs.	Silver			Bronze			White			Black		
			Item #	1-5	6+	Item #	1-5	6+	Item #	1-5	6+	Item #	1-5	6+
PTA-238	2-3/8"	.65	340238	\$90	\$84	340247	\$101	\$90	340256	\$101	\$90	340265	\$101	\$90
PTA-212	2-1/2"	.68	340239	90	84	340248	101	90	340257	101	90	340266	101	90
PTA-3	3"	1.0	340240	126	116	340249	137	125	340258	137	125	340267	137	125
PTA-312	3-1/2"	1.3	340241	126	116	340250	137	125	340259	137	125	340268	137	125
PTA-4	4"	1.6	340242	151	132	340251	164	147	340260	164	147	340269	164	147
PTA-412	4-1/2"	2.0	340243	151	132	340252	164	147	340261	164	147	340270	164	147
PTA-5	5"	2.4	340244	151	132	340253	164	147	340262	164	147	340271	164	147
PTA-512	5-1/2"	2.9	340245	197	176	340254	213	191	340263	213	191	340272	213	191
PTA-6	6"	3.8	340246	197	176	340255	213	191	340264	213	191	340273	213	191

## FLAGPOLE CAPS

Cast aluminum construction designed to slip over the top of the flagpole and be secured with three 1/4"-20NC stainless steel set screws. The top of the cap is designed to accept an ornament with a spindle threading of 1/2"-13NC. Please specify color when ordering. If not specified, silver will be supplied.



Model	Fits Pole Diameter	Lbs.	Silver			Bronze			White			Black		
			Item #	1-5	6+	Item #	1-5	6+	Item #	1-5	6+	Item #	1-5	6+
FC-20	2"	.60	340274	\$35.50	\$32.00	340276	\$41.00	\$38.50	340278	\$41.00	\$38.50	340280	\$41.00	\$38.50
FC-212	2-1/2"	.60	340275	41.00	38.50	340277	44.00	41.50	340279	44.00	41.50	340281	44.00	41.50

## ROPE PULLEYS

\* 340356 is also used with our Vertical Mount Pulley Assemblies. Please note that the diameter of all of our nylon pulleys can vary plus or minus 1/16".

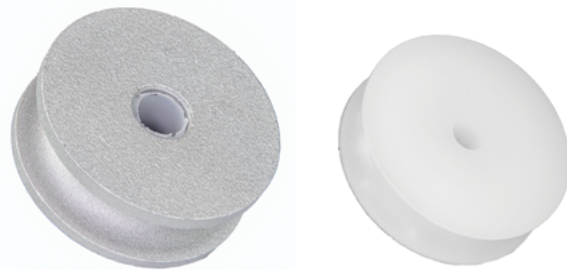

Aluminum

Nylon

Item #	Dia.	Width	Material	Maximum Axle Dia.	Maximum Rope Dia.	Used With Our Truck Model Number...	1-5	6+	Lbs.
340302	1"	3/8"	Nylon	3/16"	1/4"	ST-1-38, ST-1-12, ST-1-16, ST-1-20	\$5.70	\$5.10	.01
340356*	1-1/2"	1/2"	Nylon	1/4"	1/4"	OTH, IH-1-35, OT35	7.90	6.80	.03
340355	1-1/2"	9/16"	Nylon	1/4"	1/4"	ST2, ST3, OT1, OT25, IH-1 Inner Pulley Insert	7.90	6.80	.03
340358	1-1/2"	3/4"	Nylon	1/4"	5/16"	RTS-1-125, RTC-1-138, RTC-1-2, RTC-1-238	8.30	7.90	.04
340357	1-15/16"	9/16"	Nylon	1/4"	5/16"	RTS-2-125, RTC-2-138, RTC-2-2, RTC-2-238	8.30	7.90	.04
340320	2"	1/2"	Nylon	1/4"	5/16"	OT2, OT3, OT325, IH-1-3, IHT-VS	6.80	6.20	.04
340359	2-1/2"	7/8"	Aluminum	1/2"	3/8"	HDT-1	39.50	35.50	.40
340305	3-3/4"	3/4"	Aluminum	1/2"	3/8"	HDT-2	40.00	37.00	.45

# OUTDOOR FLAGPOLE ACCESSORIES



Deluxe



Standard

## PULLEY & EYEBOLT ASSEMBLIES

Includes hex nut, washer & lock washer

Model	Item #	Overall Length	Thread Length	Bolt Threading	Bolt Material	Pulley Housing Material	Pulley Material	Max. Rope Diameter	1-5	6+	Lbs.
Deluxe	340236	4-1/8"	2-3/8"	5/16"-18NC	Stainless Steel	Stainless Steel	Nylon	5/16"	\$32.50	\$31.00	.02
Standard	340237	3-1/8"	1"	#8-32NC	Zinc Plated Steel	Zinc	Zinc	3/16"	9.80	8.90	.07



## VERTICAL MOUNT PULLEY ASSEMBLIES

Cast aluminum construction. 1-1/2" outside diameter cast nylon pulley on a 1/4" stainless steel axle. Attaches with two 1/4"-20NC stainless steel flat head screws or two stainless steel straps (not included). Maximum halyard diameter is 5/16". Not supplied as standard with holes drilled for mounting. **Add \$2.00 for drilling.**

Item #	Color	1-5	6+	Lbs.
340298	Silver	\$46.00	\$42.50	.60
340299	Bronze	52.00	48.00	.60
340300	Black	52.00	48.00	.60
340301	White	52.00	48.00	.60



## THREADED TOP PLUGS

Screws into top of pole with 1-1/4" NPT threading and allows for insertion of ornament with either a 1/2"-13NC or 5/8"-11NC spindle threading.

Item #	For Ornament Spindle Size	1-5	6+	Lbs.
340306	1/2"-13NC	\$49.00	\$44.50	.25
340307	5/8"-11NC	54.00	48.00	.25

## STANDARD CAST ALUMINUM CLEATS

- Two 1/4"-20NC stainless steel mounting screws included
- Standard colors are: silver, bronze, white & black
- If not specified when ordering, silver will be supplied



Model	Length	Distance Between Hole Centers	Lbs.	Silver		Bronze		White		Black					
				Item #	1-5	6+	Item #	1-5	6+	Item #	1-5	6+			
CL6	6"	2"	.25	350000	\$16.00	\$14.50	350002	\$19.70	\$17.10	350004	\$19.70	\$17.10	350006	\$19.70	\$17.10
CL9	9"	2-3/4"	.55	350001	21.90	19.10	350003	24.20	21.80	350005	24.20	21.80	350007	24.20	21.80

## LIGHT-DUTY CAST ALUMINUM CLEATS

- Two #10-5/8" self-tapping flat head mounting screws included
- Standard colors are: silver, bronze, white & black
- If not specified when ordering, silver will be supplied



Model	Length	Distance Between Hole Centers	Lbs.	Silver		Bronze		White		Black					
				Item #	1-5	6+	Item #	1-5	6+	Item #	1-5	6+			
CLC	4-1/2"	3/4"	.04	350008	\$8.20	\$7.80	350010	\$10.90	\$9.70	350012	\$10.90	\$9.70	350014	\$10.90	\$9.70
CLH	6"	1"	.06	350009	8.70	8.30	350011	12.20	11.70	350013	12.20	11.70	350015	12.20	11.70

**HEAVY-DUTY CAST ALUMINUM CLEAT**

- Two 3/8"-16NC stainless steel slotted flat head screws included
- Standard colors are: silver, bronze, white & black
- If not specified when ordering, silver will be supplied



Length	Distance Between Hole Centers	Lbs.	Silver			Bronze			White			Black		
			Item #	1-5	6+	Item #	1-5	6+	Item #	1-5	6+	Item #	1-5	6+
14-3/4"	4-7/8"	2.2	350016	\$164.00	\$153.00	350017	\$175.00	\$169.00	350018	\$175.00	\$169.00	350019	\$175.00	\$169.00



**CAST NYLON CLEATS**

Two #10-1-1/2" self-tapping mounting screws included

Model	Item #	Color	Distance Between Hole Centers		Lbs.	
			1-5	6+		
CLP-G	350020	Gray	1-1/8"	\$6.20	\$5.70	.07
CLP-W	350021	White	1-1/8"	6.20	5.70	.07

**STANDARD STAINLESS STEEL CLEATS**

Mirror finished cleat with two 1/4"-20NC stainless steel mounting screws included

Model	Length	Distance Between Hole Centers		Lbs.	Item #	Price
		1-5	6+			
CL9/SS	9"	2-3/4"	1.16	350024	\$53.00	

**CLEAT COVER BOXES**

Cast aluminum with stainless steel hinge pins. Design allows for easy installation utilizing the cleat holes to mount the cleat cover box. Comes complete with your choice of padlock or cylinder lock. Two extra long 1/4"-20NC stainless steel mounting screws are included. The distance between bolt centers is 2-3/4". Rope cleat is not included - recommended cleats are the CL9; see previous page for pricing. Standard colors are Silver, or painted to match Bronze, White or Black.

**With Cylinder Lock And Mounting Screws**

Model	Fits Pole Dia.	Lbs.	Silver			Bronze		
			Item #	1-5	6+	Item #	1-5	6+
CBC-335	3"-3½"	5.0	350042	\$223	\$197	350050	\$243	\$223
CBC-412	4"-12"	5.0	350043	223	197	350051	243	223

Model	Fits Pole Dia.	Lbs.	White			Black		
			Item #	1-5	6+	Item #	1-5	6+
CBC-335	3"-3½"	5.0	350054	\$243	\$223	350058	\$243	\$223
CBC-412	4"-12"	5.0	350055	243	223	350059	243	223

**With Padlock And Mounting Screws**

Model	Fits Pole Dia.	Lbs.	Silver			Bronze		
			Item #	1-5	6+	Item #	1-5	6+
CB-335	3"-3½"	5.6	350044	\$236	\$213	350052	\$264	\$236
CB-412	4"-12"	5.6	350045	236	213	350053	264	236

Model	Fits Pole Dia.	Lbs.	White			Black		
			Item #	1-5	6+	Item #	1-5	6+
CB-335	3"-3½"	5.6	350056	\$264	\$236	350060	\$264	\$236
CB-412	4"-12"	5.6	350057	264	236	350061	264	236



# OUTDOOR FLAGPOLE ACCESSORIES

## HALYARD COVERS WITH MOUNTING SCREWS

This 1-3/4" wide by 1" deep aluminum channel is designed to be used with the cleat cover boxes on [page 155](#) to provide additional protection 5' above the cleat cover box. The 5' and 6' models have an upper & lower hinge assembly and is secured to the pole with six #10-32NC stainless steel pan head screws (included). Note: Shown with cleat cover box which is sold separately and is not included in the pricing below. Standard colors are Silver, Clear Anodized, Bronze Anodized, Black Anodized, or painted White.



Model	Length	Lbs.	Item #	Silver		Clear			Bronze			White			Black		
				1-5	6+	Item #	1-5	6+	Item #	1-5	6+	Item #	1-5	6+	Item #	1-5	6+
HC-5	5'	5.1	350066	\$211	\$187	350070	\$256	\$229	350074	\$256	\$229	350078	\$256	\$229	350082	\$256	\$229
HC-6	6'	5.9	350067	229	211	350071	285	256	350075	285	256	350079	285	256	350083	285	256

## CLEAT SCREWS

	Material	Length	Thread	Color	Item #	Price	Lbs.
A	Stainless Steel	1-1/2"	1/4"-20NC	Silver	350025	\$1.60	.05
B	Zinc Plated Steel	3"	3/8"-16NC	Silver	350026	3.28	.18
C	Zinc Plated Steel	5/8"	#10	Silver	350027	0.54	.01
D	Zinc Plated Steel	1-1/2"	#10	Silver	350028	0.56	.01
D	Stainless Steel	1-1/2"	#14	White Painted	350249	1.68	.05
E	Brass Alloy	1-1/2"	1/4"-20NC	Brass	350041	1.64	.02

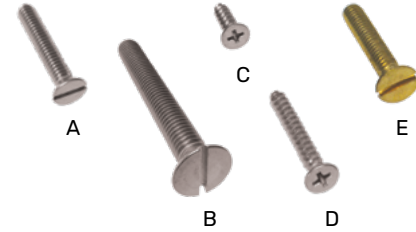

## LOCKS & KEYS FOR CLEAT BOXES

Model	Item #	Description	1-5	6+	Lbs.
CBC-L	350090	Cylinder Lock With Keys	\$27.70	\$25.70	.14
CBC-K	360292	Key Only For Cylinder Lock	11.40	11.10	.04
CB-L	350092	Padlock With Keys	20.50	18.80	.46



## CLEAT COVER BOX MOUNTING SCREW

2-1/2" x 1/4"-20NC

Item #	Color	Price	Lbs.
350062	Silver	\$1.66	.03



## HALYARD COVER MOUNTING SCREW

5/8" x #10-32NC stainless steel

Item #	Color	Price	Lbs.
350086	Silver	\$0.74	.01



## STAINLESS STEEL SPRING CLIPS

Item #	Length	1-11	12-143	144+	Lbs.
350136	2-3/8"	\$5.50	\$4.50	\$4.30	.06
350254	2-3/4"	7.30	6.90	6.40	.09





**SOLID BRASS SWIVEL SNAPS**

Model	Item#	Length	1-11	12-143	144+	Lbs.
ESS	350124	3"	\$7.90	\$7.10	\$6.80	.13
ESSL	350125	3-3/4"	11.00	9.80	9.00	.17
ESSXL	350126	4-3/4"	18.80	16.70	15.80	.30



**CHROME PLATED BRASS SWIVEL SNAP**

Model	Item#	Length	1-11	12-143	144+	Lbs.
ESSC	350128	3-1/2"	\$11.00	\$9.70	\$8.50	.13



**SOLID BRASS DOUBLE SNAP**

Model	Item#	Length	1-11	12-143	144+	Lbs.
DS-4	350135	4"	\$9.60	\$8.50	\$7.80	.14



White



Brown

**RUBBER COATED BRASS SWIVEL SNAPS**

Model	Item#	Length	Color	1-11	12-143	144+	Lbs.
ESR-W	350133	3"	White	\$16.90	\$16.00	\$13.40	.13
ESR-B	350134	3"	Brown	17.60	16.90	14.20	.13



**NICKEL PLATED ZINC SWIVEL SNAP**

Model	Item#	Length	1-11	12-143	144+	Lbs.
ESSZ	350127	3-1/2"	\$6.30	\$6.00	\$5.40	.10



**STAINLESS STEEL SWIVEL SNAPS**

Model	Item#	Length	1-11	12-143	144+	Lbs.
SSFS1	350129	3-3/4"	\$32.00	\$30.50	\$28.50	.13
SSFS2	350130	4-3/4"	39.50	36.50	35.00	.28



**NYLON SNAPS**

Model	Item#	Length	1-11	12-143	144+	Lbs.
ESN	350131	2-3/4"	\$1.30	\$1.24	\$1.18	.01
EVL	350132	3"	16.40	15.50	15.20	.04



**STAINLESS STEEL SWIVEL SNAP WITH LARGE EYE OPENING**

Ideal for 25' x 40' flags and larger.

Model	Item#	Length	1-11	12-143	144+	Lbs.
SSFS3	350257	4-3/4"	\$41.50	\$39.50	\$36.00	.35

# OUTDOOR FLAGPOLE ACCESSORIES

## VINYL SNAP COVERS

Model	Item#	Color	Len.	Dia.	1-11	12-143	144+	Lbs.
EVC-G	350137	Gray	3-1/2"	1-1/4"	\$4.00	\$3.70	\$3.60	.05
EVC-B	350138	Brown	3-1/2"	1-1/4"	4.00	3.70	3.60	.05
EVC-BL	350258	Black	3-1/2"	1-1/4"	4.00	3.70	3.60	.05
EVCXL-G	350139	Gray	4-1/4"	1-1/2"	5.60	5.40	5.00	.08
EVCXL-B	350140	Brown	4-1/4"	1-1/2"	5.60	5.40	5.00	.08
EVCXL-BL	350259	Black	4-1/4"	1-1/2"	5.60	5.40	5.00	.08

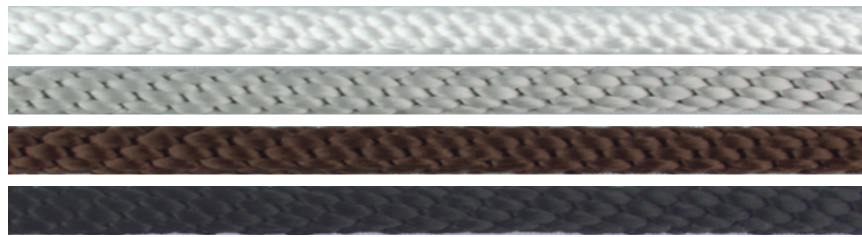

## POLYESTER HALYARD - SOLID BRAIDED

Cut-To-Length - Priced Per Foot

Model	Dia.	Lbs.	Item#	White		Silver		Bronze		Black	
				Price	Item#	Price	Item#	Price	Item#	Price	Item#
PH6	3/16"	.01	350195	\$0.48	350200	\$0.50	350204	\$0.50	350208	\$0.50	
PH8	1/4"	.01	350196	0.52	350201	0.56	350205	0.56	350209	0.56	
PH10	5/16"	.02	350197	0.60	350202	0.64	350206	0.64	350210	0.64	
PH12	3/8"	.02	350198	0.74	350203	0.84	350207	0.84	350211	0.84	



### Spools

Model	Feet Per Spool	Dia.	Lbs.	Item#	White		Silver		
					1-2 Spools	3+ Spools	Item#	1-2 Spools	3+ Spools
PH6	1,500	3/16"	16	350195	\$719	\$482	350200	\$749	\$574
PH8	1,000	1/4"	14	350196	519	361	350201	558	410
PH10	600	5/16"	11	350197	361	290	350202	384	313
PH12	600	3/8"	15	350198	446	338	350203	504	361
PH16	250	1/2"	16	350199	746	649	-	-	-

Model	Feet Per Spool	Dia.	Lbs.	Item#	Bronze		Black		
					1-2 Spools	3+ Spools	Item#	1-2 Spools	3+ Spools
PH6	1,500	3/16"	16	350204	\$749	\$574	350208	\$749	\$574
PH8	1,000	1/4"	14	350205	558	410	350209	558	410
PH10	600	5/16"	11	350206	384	313	350210	384	313
PH12	600	3/8"	15	350207	504	361	350211	504	361



**POLYESTER HALYARD - SOLID BRAIDED**

Pre-Bagged

Model	Length	Dia.	Lbs.	White		Silver		Bronze	
				Item#	Price	Item#	Price	Item#	Price
NH4	28'	1/8"	.12	350141	\$7.30	-	-	-	-
PH6	30'	3/16"	.30	350142	15.20	350154	\$16.90	350166	\$16.90
PH6	40'	3/16"	.40	350143	20.30	-	-	350167	21.70
PH8	30'	1/4"	.34	-	-	350252	18.00	-	-
PH8	40'	1/4"	.45	350144	21.80	350156	25.30	350168	25.30
PH8	50'	1/4"	.65	350145	27.20	350157	29.30	350169	29.30
PH8	60'	1/4"	.75	350146	31.80	350158	34.60	350170	34.60
PH10	40'	5/16"	.90	-	-	350253	27.20	-	-
PH10	50'	5/16"	.90	350147	31.80	350159	34.60	350171	34.60
PH10	60'	5/16"	.95	350148	36.90	350160	38.90	350172	38.90
PH10	70'	5/16"	1.2	350149	41.30	350161	45.80	350173	45.80
PH10	80'	5/16"	1.4	350150	48.10	350162	50.40	350174	50.40
PH10	90'	5/16"	1.5	350151	52.50	350163	57.20	350175	57.20
PH10	100'	5/16"	1.5	350152	59.60	350164	64.00	350176	64.00
PH12	120'	3/8"	2.5	350153	73.60	350165	82.00	350177	82.00



**TECHNORA® FLAGPOLE HALYARD**

High performance fibers are encased inside a polyester fiber yarn jacket resulting in a high strength, low stretch, U.V. and abrasion resistant flagpole halyard. Available in White.

Item#	Description	Dia.	Color	Price	Lbs.
350256	Cut-To-Length	1/4"	White	\$2.33/Foot	.02
350256	1000' Spool	1/4"	White	\$2,330/Spool	18

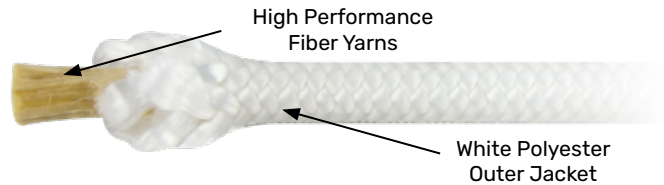

**ZIPKLIP® FLAG FASTENERS**

These nylon flag fastener clips are sold two per set and come complete with stainless steel spring clips. The clips are held firmly in place with a positive lock set screw. Maximum rope diameter 5/16".

Item#	Price	Lbs.
350255	\$16.70 Per Set of Two	.20



# OUTDOOR FLAGPOLE ACCESSORIES

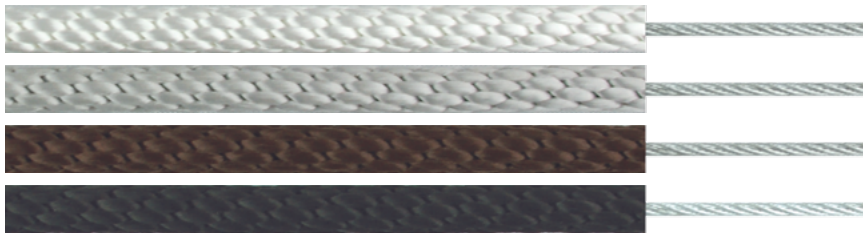

## POLYESTER WIRE CENTER HALYARD

Cut-To-Length - Priced Per Foot

Model	Dia.	Lbs.	White		Silver		Bronze		Black	
			Item#	Price	Item#	Price	Item#	Price	Item#	Price
NWCH6	3/16"	.03	350228	\$1.07	350232	\$1.16	350236	\$1.16	350240	\$1.16
NWCH8	1/4"	.03	350229	1.16	350233	1.20	350237	1.20	350241	1.20
NWCH10	5/16"	.04	350230	1.44	350234	1.52	350238	1.52	350242	1.52
NWCH12	3/8"	.04	350231	1.93	350235	2.00	350239	2.00	350243	2.00



### Spools

Model	Feet Per Spool	Dia.	Lbs.	White		Silver	
				Item#	Price	Item#	Price
NWCH6	1,000	3/16"	32	350228	\$1,073	350232	\$1,158
NWCH8	1,000	1/4"	35	350229	1,158	350233	1,200
NWCH10	500	5/16"	21	350230	718	350234	761
NWCH12	500	3/8"	26	350231	965	350235	1,001

Model	Feet Per Spool	Dia.	Lbs.	Bronze		Black	
				Item#	Price	Item#	Price
NWCH6	1,000	3/16"	31	350236	\$1,158	350240	\$1,158
NWCH8	1,000	1/4"	34	350237	1,200	350241	1,200
NWCH10	500	5/16"	20	350238	761	350242	761
NWCH12	500	3/8"	23	350239	1,001	350243	1,001





**M-WINCH:**  
**Reliable. Maintenance-Free. Built to Last.**

Our M-Winch features a gearless, self-locking design that holds securely at any position—no separate brake required. Its direct-drive system ensures smooth and efficient raising and lowering of your flag.

Designed for durability and ease, the M-Winch requires no welding, eliminating the risk of discoloration on anodized finishes. Completely maintenance-free, it never needs lubrication.

Installation is simple: the winch slides into the pole and is secured with a stainless steel bolt on the back. Each unit comes with a lock and key for added security.

Model	Fits Pole Dia.	Lbs.	Item#	Satin		Clear		Bronze		White		Black	
				Price	Item#	Price	Item#	Price	Item#	Price	Item#	Price	Item#
M-5	5" w/.125 WALL	1.3	360000	\$790	360009	\$830	360018	\$830	360027	\$830	360036	\$830	360036
M-5	5" w/.156 or .188 WALL	1.3	360516	790	360517	830	360518	830	360519	830	360520	830	360520
M-6	6"	2.1	360001	1,250	360010	1,290	360019	1,290	360028	1,290	360037	1,290	360037
M-6H	6" w/.250 WALL	2.1	360501	1,250	360502	1,290	360503	1,290	360505	1,290	360504	1,290	360504
M-7	7"	2.3	360002	1,250	360011	1,290	360020	1,290	360029	1,290	360038	1,290	360038
M-8	8"	4.5	360003	1,400	360012	1,470	360021	1,470	360030	1,470	360039	1,470	360039
M-10	10"	4.9	360004	1,470	360013	1,520	360022	1,520	360031	1,520	360040	1,520	360040
M-10H	10"	4.9	360508	1,470	360509	1,520	360510	1,520	360512	1,520	360511	1,520	360511
M-1034	10-3/4"	5.1	360005	1,700	360014	1,770	360023	1,770	360032	1,770	360041	1,770	360041
M-12	12" w/.250 WALL	5.0	360466	1,700	360467	1,770	360468	1,770	360469	1,770	360470	1,770	360470
M-12	12" w/.375 WALL	5.0	360006	1,700	360015	1,770	360024	1,770	360033	1,770	360042	1,770	360042
M-1234	12-3/4"	7.9	360007	3,430	360016	3,450	360025	3,450	360034	3,450	360043	3,450	360043
M-14	14"	8.1	360008	3,430	360017	3,450	360026	3,450	360035	3,450	360044	3,450	360044

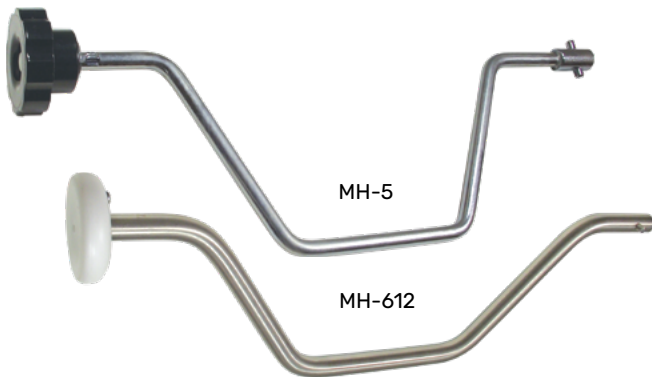

**LOCK & KEY FOR M-WINCHES**

\* Please provide number located on cylinder lock when ordering replacement keys.

**M-WINCH HANDLES**

Model	Item#	For M-Winch Model #	Price	Lbs.
MH-5	360045	M-5	\$92	.50
MH-612	360046	M-6 Thru M-14	\$196	1.1

Model	Item#	Description	Price	Lbs.
M-L	360054	Lock with Key	\$123	.08
M-K	360055	Key Only*	\$17	.01

Products on this page are intended exclusively as replacement parts for Eder Flag products. Their warranty is valid only when used with factory-installed Eder Flag shafts. Any request for service or warranty coverage must include invoice documentation for both the product and the shaft.

## STAINLESS STEEL WINCHES

These winches are available for use on flagpoles with a butt diameter of 6" or larger. These gearless winches utilize cast bronze internal brakes which release when a winch handle is inserted and rotational pressure is applied. The winch is locked at any position by removing the handle which engages the brake system. The small size is generally used on flagpoles up to 45'; the large size is used on flagpoles from 50' thru 80' and the X-Large size is used on flagpoles higher than 80'. The winch is mounted to the inside of the flagpole with two 5/16"-18NC stainless steel bolts with mounting centers being 3-1/2". Recommended stainless steel cable diameter is 1/8". Monthly lubrication required.

Model	Item#	Size	Height	Width	Drum Width	1-5	6+	Lbs.
SSW1	360047	Small	4-1/8"	3-1/8"	1-1/2"	\$800	\$770	3.5
SSW2	360048	Large	4-1/8"	3-5/8"	2"	800	770	3.8
SSW3	360049	X-Large	4-1/8"	6-5/8"	5"	1,380	1,270	4.8

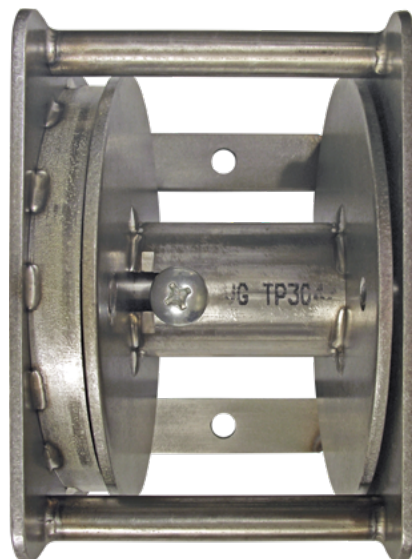

## HANDLE FOR STAINLESS STEEL WINCHES

Designed to be used with any of the stainless steel winches described above.

Model	Item#	1-5	6+	Lbs.
WH1	360051	\$77.00	\$71.00	1.3



## CAM ACTION CLEATS

Used in rope style internal halyard flagpoles. The mounted version is secured onto a 1-1/2" x 3-3/8" aluminum block with two #10-32NC stainless steel pan head screws. The unmounted version is also supplied with two #10-32NC stainless steel mounting screws. Recommended maximum rope diameter is 5/16".

Item#	Description	1-5	6+	Lbs.
360052	Mounted	\$60.00	\$53.00	.50
360053	Unmounted	34.00	32.50	.25



Mounted



Unmounted

## STANDARD FLAG ARRANGEMENTS

Constructed of 1/8" stainless steel aircraft cable with a stainless steel thimble attached at each end with 2 copper crimps. These flag arrangements provide the method of attaching the flag or flags to the cable assembly. This is also an excellent method for changing the quantity of flags or the size(s) of flag(s) without having to change the entire cable assembly. Standard flag arrangements are supplied with either 2 or 3 stainless steel quick links depending on the recommended flag size. Deluxe arrangements are supplied with a more complete set of accessories.

Model	Item#	For Flag Size	# of Quick Links	1-5	6+	Lbs.
FA1	360473	12" x 18"	2	\$56	\$48	.35
FA2	360079	2' x 3'	2	68	64	.50
FA25	360080	2-1/2' x 4'	2	74	68	.55
FA3	360081	3' x 5'	2	77	69	.55
FA4	360082	4' x 6'	2	79	74	.60
FA5	360083	5' x 8' or 5' x 9-1/2'	2	83	77	.65
FA6	360084	6' x 10'	2	88	83	.65
FA8	360085	8' x 12'	3	183	161	.70
FA10	360086	10' x 15' or 10' x 19'	3	187	167	.95
FA12	360087	12' x 18'	3	200	183	1.0
FA15	360088	15' x 25'	3	205	191	1.1
FA20	360089	20' x 30' or 20' x 38'	3	213	193	1.3
FA25	360090	25' x 40'	3	232	210	2.0
FA30	360091	30' x 50' or 30' x 60'	3	239	213	2.8

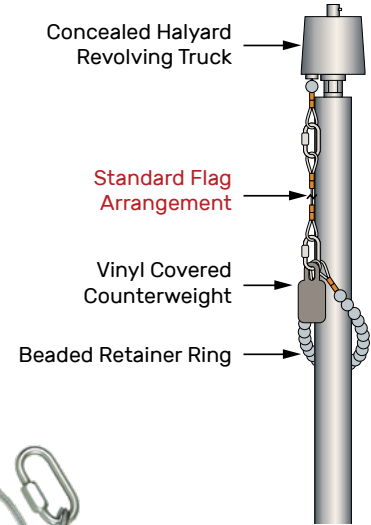

Arrangement shown with 2 Quick Links

## DELUXE FLAG ARRANGEMENTS

Constructed of 1/8" stainless steel aircraft cable with a stainless steel thimble attached at each end with 2 copper crimps. These flag arrangements provide the method of attaching the flag or flags to the cable assembly. This is also an excellent method for changing the quantity of flags or the size(s) of flag(s) without having to change the entire cable assembly. Deluxe flag arrangements are supplied with either 2 or 3 stainless steel quick links and stainless steel swivel snaps depending on recommended flag size. Shock spring and safety cable are supplied on 8'x12' and larger flag sizes.

Model	Item#	For Flag Size	Supplied With				1-5	6+	Lbs.
			Quick Links	Flag Snaps	Shock Spring	Safety Cable			
FA2	360474	2' x 3'	2	2 (Stainless Steel SSFS-1)	-	-	\$104	\$96	1.2
FA25	360475	2-1/2' x 4'	2	2 (Stainless Steel SSFS-1)	-	-	116	101	1.3
FA3	360476	3' x 5'	2	2 (Stainless Steel SSFS-1)	-	-	118	104	1.3
FA4	360477	4' x 6'	2	2 (Stainless Steel SSFS-1)	-	-	123	112	1.3
FA5	360478	5' x 8' or 5' x 9-1/2'	2	2 (Stainless Steel SSFS-1)	-	-	129	118	1.4
FA6	360479	6' x 10'	2	2 (Stainless Steel SSFS-1)	-	-	142	129	1.4
FA8	360480	8' x 12'	3	2 (Stainless Steel SSFS-2)	1	1	203	183	2.3
FA10	360481	10' x 15' or 10' x 19'	3	2 (Stainless Steel SSFS-2)	1	1	205	187	2.6
FA12	360482	12' x 18'	3	2 (Stainless Steel SSFS-2)	1	1	217	200	2.6
FA15	360483	15' x 25'	3	2 (Stainless Steel SSFS-2)	1	1	224	205	2.7
FA20	360484	20' x 30' or 20' x 38'	3	2 (Stainless Steel SSFS-2)	1	1	238	213	2.9
FA25	360485	25' x 40'	3	2 (Stainless Steel SSFS-2)	1	1	245	217	3.6
FA30	360486	30' x 50' or 30' x 60'	3	2 (Stainless Steel SSFS-2)	1	1	250	219	4.4



Arrangement for flag size 6' x 10' or smaller

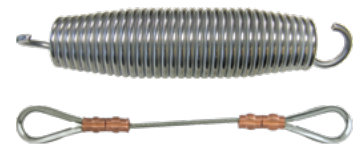

Shock spring and Safety Cable supplied with arrangements for 8' x 12' or larger flag sizes

# OUTDOOR FLAGPOLE ACCESSORIES

## CABLE ASSEMBLIES

Constructed of stainless steel aircraft cable incorporating a stainless steel swivel to minimize stress on the cable and reduce the possibility of the lower cable twisting due to the rotation of the truck assembly. If ordering a cable assembly separate from a flagpole, some field assembly will be required as the upper cable must be threaded through the truck assembly. The thimble and crimps for the outer end of the assembly are sent unattached. Standard cable assemblies are designed for flagpoles with an M-Winch installed at 4' above grade.

\*To be used with 5" diameter poles with our M-5 Winch installed.

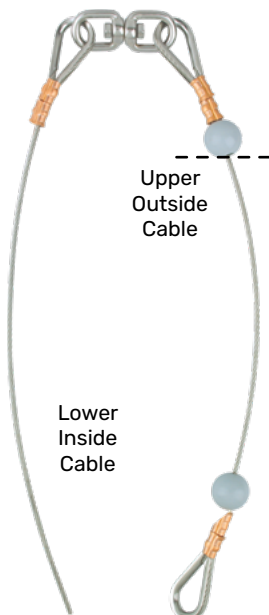

Item#	Exposed Ht. of Flagpole	Lower Inside Cable		Upper Outside Cable		1-5	6+	Lbs.
		Dia.	Len.	Dia.	Len.			
360056	20'	3/32"	17'	1/8"	17'	\$164	\$150	1.4
360332	25**	3/32"	21'	1/8"	21'	185	161	1.6
360057	25'	1/8"	21'	1/8"	21'	185	161	1.9
360333	30**	3/32"	27'	1/8"	27'	197	176	1.9
360058	30'	1/8"	27'	1/8"	27'	197	176	2.2
360334	35**	3/32"	31-1/2'	1/8"	31-1/2'	209	189	2.1
360059	35'	1/8"	31-1/2'	1/8"	31-1/2'	209	189	2.5
360060	40'	1/8"	37'	3/16"	37'	228	208	4.2
360061	45'	1/8"	42'	3/16"	42-1/2'	238	216	4.6
360062	50'	1/8"	46'	3/16"	46-1/2'	261	231	5.1
360063	60'	1/8"	56-1/2'	3/16"	57'	324	294	6.1
360064	70'	1/8"	66-1/2'	3/16"	67'	345	309	7.0
360066	80'	1/8"	76-1/2'	3/16"	77'	365	334	8.0
360067	90'	1/8"	86-1/2'	3/16"	87'	466	420	8.9
360068	100'	1/8"	96-1/2'	3/16"	97'	496	454	9.9
360069	110'	1/8"	106-1/2'	3/16"	107'	517	466	11
360070	120'	1/8"	116-1/2'	3/16"	117'	527	474	12
360071	130'	1/8"	126-1/2'	3/16"	127'	606	547	13
360072	140'	1/8"	136-1/2'	3/16"	137'	626	560	14
360073	150'	1/8"	146-1/2'	3/16"	147'	669	606	15
360074	160'	1/8"	156-1/2'	3/16"	157'	713	647	16
360075	170'	1/8"	166-1/2'	3/16"	167'	755	681	17
360076	180'	1/8"	176-1/2'	3/16"	177'	842	755	18
360077	190'	1/8"	186-1/2'	3/16"	187'	904	815	19
360078	200'	1/8"	196-1/2'	3/16"	197'	995	893	20

## ROPE ASSEMBLIES

These assemblies are typically used in rope style internal halyard flagpoles where a cam cleat has been installed. Comes complete with a zinc plated carbon steel rope thimble attached to one end of the rope and stainless steel quick link.



Poly Rope Assembly # 360096 shown

### Polyester Rope Assemblies

Ht. of Pole	Len. of Rope	Dia. of Rope	Lbs.	White			Silver			Bronze			Black		
				Item#	1-5	6+	Item#	1-5	6+	Item#	1-5	6+	Item#	1-5	6+
20'	50'	1/4"	1.7	360096	\$34.50	\$31.00	360106	\$34.50	\$31.00	360116	\$34.50	\$31.00	360126	\$34.50	\$31.00
25'	60'	1/4"	2.1	360097	39.00	34.50	360107	40.00	37.00	360117	40.00	37.00	360127	40.00	37.00
30'	70'	1/4"	2.4	360098	41.50	39.00	360108	44.00	40.00	360118	44.00	40.00	360128	44.00	40.00
35'	80'	1/4"	2.7	360099	44.00	41.50	360109	46.50	43.00	360119	46.50	43.00	360129	46.50	43.00
40'	90'	1/4"	3.1	360100	50.50	44.00	360110	54.00	46.50	360120	54.00	46.50	360130	54.00	46.50

### Polyester With Wire Center Rope Assemblies

Ht. of Pole	Len. of Rope	Dia. of Rope	Lbs.	White			Silver			Bronze			Black		
				Item#	1-5	6+	Item#	1-5	6+	Item#	1-5	6+	Item#	1-5	6+
20'	50'	3/16"	1.6	360137	\$60	\$56	360147	\$68	\$61	360157	\$68	\$61	360167	\$68	\$61
25'	60'	3/16"	1.9	360138	68	61	360148	80	74	360158	80	74	360168	80	74
30'	70'	3/16"	2.2	360139	75	69	360149	91	83	360159	91	83	360169	91	83
35'	80'	3/16"	2.5	360140	84	77	360150	105	97	360160	105	97	360170	105	97
40'	90'	3/16"	2.8	360340	124	93	360341	132	122	360342	132	122	360343	132	122

**TECHNORA® ROPE ASSEMBLIES**

High performance fibers are encased inside a polyester fiber yarn jacket resulting in a high strength, low stretch, U.V. and abrasion resistant flagpole halyard.

Ht. of Pole	Len. of Rope	Dia. of Rope	Lbs.	Item#	White	
					1-5	6+
20'	50'	1/4"	2.0	360495	\$114	\$101
25'	60'	1/4"	2.4	360496	138	125
30'	70'	1/4"	2.7	360497	169	155
35'	80'	1/4"	3.0	360498	183	160
40'	90'	1/4"	3.4	360499	205	187

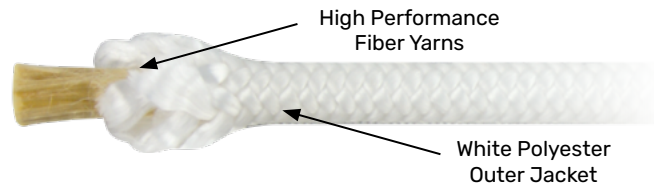

**ROPE RETAINER RINGS**

Retainer rings are generally used with internal halyard flagpoles by providing a means of keeping the bottom of the flag close to the pole and as an aid to raise and lower the flag. Retainer rings can also be used on large multi-grommet flags on both external and internal halyard flagpoles as a means to keep the flags close to the pole and reduce the strain on the upper and lower grommets of the flag. These roped retainer rings are constructed of 3/16" polyester wire center halyard with a zinc plated carbon steel thimble attached to both ends with an aluminum crimp. Complete with stainless steel quick link. Standard colors are White, Silver, Bronze and Black. Please specify color when ordering. If not specified Silver will be supplied.

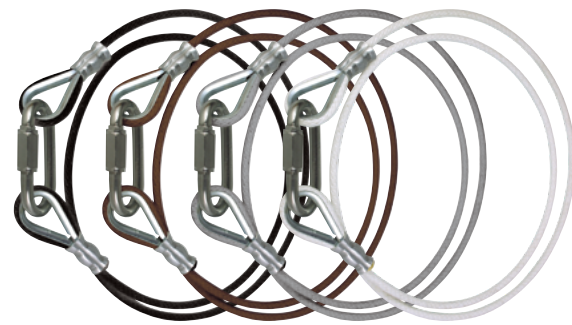

Model	Butt Dia. of Pole	Lbs.	Item#	White		Silver			Bronze			Black		
				1-5	6+	Item#	1-5	6+	Item#	1-5	6+	Item#	1-5	6+
RRR5	5"	.30	360230	\$31.00	\$28.50	360239	\$37.00	\$33.50	360248	\$37.00	\$33.50	360257	\$37.00	\$33.50
RRR6	6"	.30	360231	33.50	30.00	360240	39.00	34.50	360249	39.00	34.50	360258	39.00	34.50
RRR65	6-1/2"	.30	360232	34.50	31.00	360241	40.00	37.00	360250	40.00	37.00	360259	40.00	37.00
RRR7	7"	.32	360233	37.00	33.50	360242	43.00	40.00	360251	43.00	40.00	360260	43.00	40.00
RRR8	8"	.32	360234	39.00	34.50	360243	44.00	41.50	360252	44.00	41.50	360261	44.00	41.50
RRR10	10"	.34	360235	40.00	37.00	360244	46.50	43.00	360253	46.50	43.00	360262	46.50	43.00
RRR105	10-1/2"	.34	360236	44.00	41.50	360245	59.00	50.50	360254	59.00	50.50	360263	59.00	50.50
RRR115	11-1/2"	.36	360237	50.50	43.00	360246	65.50	59.00	360255	65.50	59.00	360264	65.50	59.00
RRR12	12"	.36	360238	56.00	46.50	360247	69.00	64.00	360256	69.00	64.00	360265	69.00	64.00
RRR16	16"	.50	360349	71.00	67.00	-	-	-	360350	86.00	79.00	-	-	-
RRR163	16-3/4"	.50	360351	86.00	79.00	-	-	-	360352	86.00	79.00	-	-	-

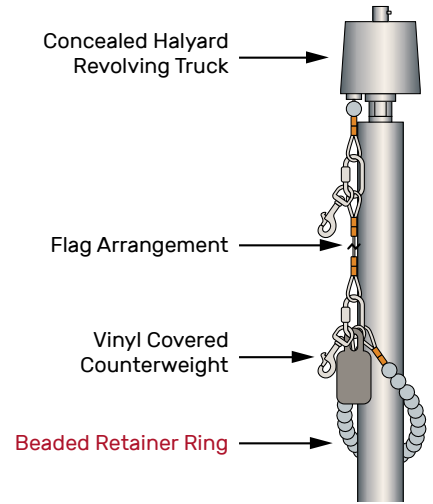

## BEADED RETAINER RINGS

Retainer rings are generally used with internal halyard flagpoles by providing a means of keeping the bottom of the flag close to the pole and as an aid to raise and lower the flag. Retainer rings can also be used on large multi-grommet flags on both external and internal halyard flagpoles as a means to keep the flags close to the pole and reduce the strain on the upper and lower grommets of the flag.

These beaded rings are constructed of either 1" or combination of 1" & 2" diameter nylon balls strung onto 1/8" stainless steel aircraft cable with a stainless steel thimble attached to each end with two copper crimps. Complete with stainless steel quick link. The length of each retainer ring is determined by measuring from the outside tip of each thimble (the quick link is not included in the measurement).

Model	Length	Pole Butt Dia.	Dia. of Balls	Lbs.	Item#	White		Silver			Bronze			Black		
						1-5	6+	Item#	1-5	6+	Item#	1-5	6+	Item#	1-5	6+
RR5	30"	5"	1"	.75	360176	\$71	\$67	360194	\$83	\$77	360212	\$83	\$77	360488	\$83	\$77
RR6	34"	6"	1"	.80	360177	74	68	360195	86	79	360213	86	79	360489	86	79
RR7	38"	7"	1"	.85	360178	78	71	360196	88	83	360214	88	83	360490	88	83
RR8	42"	8"	1"	.90	360179	79	74	360197	93	84	360215	93	84	360491	93	84
RR10	50"	10"	1"	1.1	360180	86	79	360198	96	86	360216	96	86	360492	96	86
RR11	53"	11"	1"	1.2	360181	93	83	360199	108	96	360217	108	96	360493	108	96
RR12	57"	12"	1"	1.2	360182	96	86	360200	112	98	360218	112	98	360494	112	98
RR13	61"	13"	1" & 2"	2.5	360183	185	164									
RR14	65"	14"	1" & 2"	2.7	360184	197	176									
RR16	76"	16"	1" & 2"	3.1	360185	221	203									
RR18	82"	18"	1" & 2"	3.4	360186	257	230									
RR20	92"	20"	1" & 2"	3.8	360187	279	257									
RR22	97"	22"	1" & 2"	4.2	360188	308	279									
RR24	105"	24"	1" & 2"	4.6	360189	341	308									
RR30	122"	30"	1" & 2"	5.8	360190	402	364									
RR32	131"	32"	1" & 2"	6.2	360191	428	385									
RR34	139"	34"	1" & 2"	6.6	360192	473	428									
RR36	146"	36"	1" & 2"	7.0	360193	494	452									

**NYLON RETAINER RING BALLS**

Drilled to be strung onto 1/8" stainless steel aircraft cable.

Item#	Dia. of Ball	Color of Ball	1-99	100+	
360266	1"	White	\$1.18	\$1.00	.02
360267	1"	Silver	1.28	1.20	.02
360268	1"	Bronze	1.28	1.20	.02
360487	1"	Black	1.28	1.20	.02
360269	1-1/2"	White	5.00	4.80	.06
360270	2"	White	7.70	6.80	.15



**INTERNAL HALYARD DOOR & FRAME UNITS**

This unit is designed for 5" diameter poles and is used with rope style internal halyard systems. Each unit consists of a hinged door mounted to the front of the frame and a cam cleat (optional) mounted to the back of the frame. The entire unit is inserted into the flagpole shaft and secured with eight 1/4"-20NC stainless steel screws. Lock & keys included. Standard colors are Silver, or painted to match Clear, Bronze, White or Black. Please specify color when ordering. If not specified Silver will be supplied.



Description	Lbs.	Item#	Silver		Clear			Bronze			White			Black		
			1-5	6+	Item#	1-5	6+	Item#	1-5	6+	Item#	1-5	6+	Item#	1-5	6+
With Cam Cleat	3.0	360293	\$257	\$224	-	-	-	360297	\$272	\$250	-	-	-	360301	\$272	\$250
No Cam Cleat	2.8	360294	203	187	360296	\$219	\$203	360298	219	203	360300	\$219	\$203	360302	219	203



Flat Locking Tab

**LOCK & KEYS FOR DOOR & FRAME UNIT**

This lock is suited for any of the doors listed above.

Model	Item#	Description	1-5	6+	Lbs.
DFL	360303	Lock with 2 Keys	\$26.60	\$24.60	.14
DFK	360292	Key Only	11.40	11.10	.04

# OUTDOOR FLAGPOLE ACCESSORIES



6"

7" through 12"

## INTERNAL HALYARD DOORS FOR ALUMINUM FLAGPOLES

With lock & keys

Model	Pole Dia.	Lbs.	Item#	Satin		Clear			Bronze			White			Black		
				1-5	6+	Item#	1-5	6+	Item#	1-5	6+	Item#	1-5	6+	Item#	1-5	6+
IHD6	6"	.42	360271	\$250	\$237	360276	\$259	\$246	360335	\$259	\$246	360281	\$259	\$246	360286	\$259	\$246
IHD7	7"	.46	360272	250	237	360277	259	246	360336	259	246	360282	259	246	360287	259	246
IHD8	8"	.60	360273	250	237	360278	259	246	360337	259	246	360283	259	246	360288	259	246
IHD10	10"	.72	360274	284	278	360279	306	294	360338	306	294	360284	306	294	360289	306	294
IHD12	12"	.76	360275	284	278	360280	306	294	360339	306	294	360285	306	294	360290	306	294



Bend in Locking Tab

## LOCK & KEYS FOR INTERNAL HALYARD DOORS

This lock is suited for any of the doors listed above.

Model	Item#	Description	1-5	6+	Lbs.
IHCL	360291	Lock with 2 Keys	\$26.60	\$24.60	.14
IHDK	360292	Key Only	11.40	11.10	.04



CW35



CW7 & CW14

## COUNTERWEIGHTS

Fabricated from 2" diameter steel and then coated with vinyl. The 3-1/2" pound weights are supplied with one eyebolt attached to one end while the 7 pound and 14 pound weights are supplied with an eyebolt attached to each end.

Model	Length	Lbs.	White		Silver			Bronze			Black			
			Item#	1-5	6+	Item#	1-5	6+	Item#	1-5	6+	Item#	1-5	6+
CW35	3-1/2"	3.3	360313	\$69	\$60	360316	\$69	\$60	360319	\$69	\$60	360513	\$69	\$60
CW7	7"	6.7	360314	93	84	360317	93	84	360320	93	84	360514	93	84
CW14	14"	13	360315	124	113	360318	124	113	360321	124	113	360515	124	113

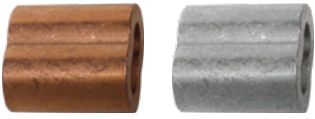

**CABLE & ROPE CRIMPS**

Model	Item#	For Cable or Rope Dia.	Material	1-5	6+	Lbs.
CC3	360328	3/32"	Copper	\$1.24	\$1.12	.01
CC1	360324	1/8"	Copper	1.24	1.12	.02
CC2	360325	5/32"	Copper	3.44	3.22	.02
ARC1	360326	1/4" - 5/16"	Aluminum	2.80	2.70	.02
ARC316	360500	3/16"	Aluminum	2.80	2.70	.02



**QUICK LINK**

Stainless steel

Model	Item#	Length	Width	1-5	6+	Lbs.
SSQL	360329	2-7/8"	1-3/8"	\$18.20	\$13.60	.20



**COPPER CABLE STOP**

For use with stainless steel winches on [page 162](#).

Model	Item#	For Cable Diameter	1-5	6+	Lbs.
CS1	360327	1/8"	\$1.24	\$1.12	.01



**CABLE SWIVEL CONNECTORS**

Stainless steel

Model	Item#	Length	Width	1-5	6+	Lbs.
IHCSC	360323	2-3/4"	1-1/8"	\$10.50	\$10.00	.20
IHCSC	360472	3-5/8"	1-3/8"	21.60	20.50	.28



**CABLE & ROPE THIMBLES**

- IHTH-3 & IHTH-1 are stainless steel
- IHTH-2 & IHTH-4 are zinc plated steel

Model	Item#	For Cable or Rope Dia.	1-5	6+	Lbs.
IHTH-3	360331	3/32"	\$4.50	\$4.00	.02
IHTH-1	360322	1/8" - 5/32"	5.20	4.60	.02
IHTH-2	300238	1/8" - 5/32"	1.78	1.46	.02
IHTH-4	360471	5/16"	2.48	1.68	.05

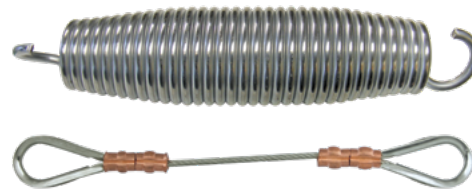

**SHOCK SPRING & SAFETY CABLE**

- Recommended for flagpoles which use arrangements for 8' x 12' or larger flags.
- The shock spring is zinc plated high carbon steel, 5-1/2" overall length.
- The safety cable is 1/8" stainless steel aircraft cable and is 9" long. Each end has a stainless steel thimble attached with 2 copper crimps.

Model	Item#	Description	1-5	6+	Lbs.
IHSS	360092	Shock Spring	\$20.20	\$18.20	.04
SCO	360093	Safety Cable	13.20	11.90	.02

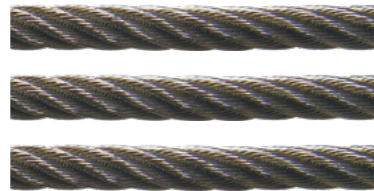

**STAINLESS STEEL CABLE**

Priced per foot

Model	Item#	Diameter	1'-199'	200'+	Lbs.
SSC32	360330	3/32"	\$3.00	\$2.80	.10
SSC18	360094	1/8"	3.00	2.80	.10
SSC316	360095	3/16"	3.40	3.00	.10

# OUTDOOR FLAGPOLE ACCESSORIES

FLASH COLLARS - STANDARD

## STANDARD PROFILE ALUMINUM FLASH COLLARS

The charts on this page contain the most commonly requested sizes. If custom sizes are needed, call or email for pricing and availability. 5" x 12" flash collars shown below. Flash collar shape may vary depending on pole diameter & outside diameter.



Satin

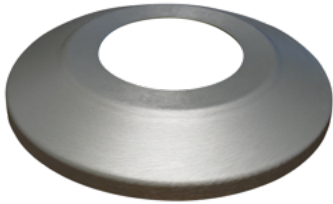

Clear

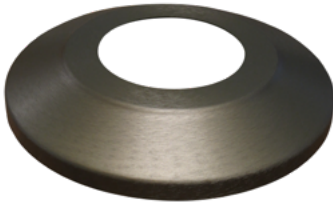

Bronze

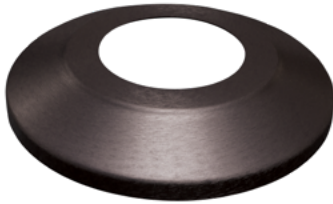

Black



White

Pole Dia.	Outside			Lbs.	Item #	Satin			Clear		
	Dia.	Ht.				1-5	6+	Item #	1-5	6+	
2"	8"	2 1/4"	.50	370000	\$40.00	\$37.00	320064	\$51.50	\$47.50		
2 3/8"	8"	2 1/4"	.45	370001	40.00	37.00	370025	51.50	47.50		
2 1/2"	8"	2 1/4"	.45	370002	40.00	37.00	320065	51.50	47.50		
2"	12"	1 1/4"	.80	370003	49.00	44.00	370026	70.00	63.00		
2 3/8"	12"	1 1/4"	.80	370004	49.00	44.00	370027	70.00	63.00		
2 1/2"	12"	1 1/4"	.80	370005	49.00	44.00	370028	70.00	63.00		
3"	12"	1 1/4"	.85	370006	49.00	44.00	370029	70.00	63.00		
3 1/2"	12"	1 1/4"	.80	370007	49.00	44.00	370030	70.00	63.00		
4"	12"	1 1/4"	.75	370008	49.00	44.00	370031	70.00	63.00		
4 3/8"	12"	1 1/4"	.75	370009	49.00	44.00	370032	70.00	63.00		
5"	12"	1 1/4"	.75	370010	49.00	44.00	370033	70.00	63.00		
5 1/2"	12"	1 1/4"	.70	370011	49.00	44.00	370034	70.00	63.00		
6"	12"	1 1/4"	.65	370012	49.00	44.00	370035	70.00	63.00		
5"	16"	2 3/8"	1.4	370633	84.00	79.00	370634	110.00	100.00		
6"	16"	2 3/8"	1.4	370013	84.00	79.00	370036	110.00	100.00		
7"	16"	2 3/8"	1.4	370014	84.00	79.00	370037	110.00	100.00		
8"	16"	2 3/8"	1.3	370015	84.00	79.00	370038	110.00	100.00		
7"	22"	3 3/8"	2.5	370016	171.00	155.00	370039	224.00	206.00		
8"	22"	3 3/8"	2.7	370017	171.00	155.00	370040	224.00	206.00		
10"	22"	3 3/8"	2.9	370018	171.00	155.00	370041	224.00	206.00		
8"	30"	4 1/4"	5.9	370019	410.00	371.00	370042	537.00	491.00		
10"	30"	4 1/4"	5.4	370020	410.00	371.00	370043	537.00	491.00		
12"	30"	4 1/4"	5.3	370021	410.00	371.00	370044	537.00	491.00		
8"	38"	4 3/4"	7.5	370022	1,101.00	978.00	370045	1,248.00	1,122.00		
10"	38"	4 3/4"	6.9	370023	1,101.00	978.00	370046	1,248.00	1,122.00		
12"	38"	4 3/4"	6.7	370024	1,101.00	978.00	370047	1,248.00	1,122.00		

Pole Dia.	Outside			Lbs.	Bronze #313			Black			White		
	Dia.	Ht.			Item #	1-5	6+	Item #	1-5	6+	Item #	1-5	6+
2"	8"	2 1/4"	.50	370048	\$51.50	\$47.50	370073	\$70.00	\$63.00	370098	\$51.50	\$47.50	
2 3/8"	8"	2 1/4"	.45	370049	51.50	47.50	370074	70.00	63.00	370099	51.50	47.50	
2 1/2"	8"	2 1/4"	.45	370050	51.50	47.50	370075	70.00	63.00	370100	51.50	47.50	
2"	12"	1 1/4"	.80	370051	70.00	63.00	370076	77.50	73.00	370101	70.00	63.00	
2 3/8"	12"	1 1/4"	.80	370052	70.00	63.00	370077	77.50	73.00	370102	70.00	63.00	
2 1/2"	12"	1 1/4"	.80	370053	70.00	63.00	370078	77.50	73.00	370103	70.00	63.00	
3"	12"	1 1/4"	.85	370054	70.00	63.00	370079	77.50	73.00	370104	70.00	63.00	
3 1/2"	12"	1 1/4"	.80	370055	70.00	63.00	370080	77.50	73.00	370105	70.00	63.00	
4"	12"	1 1/4"	.75	370056	70.00	63.00	370081	77.50	73.00	370106	70.00	63.00	
4 3/8"	12"	1 1/4"	.75	370057	70.00	63.00	370082	77.50	73.00	370107	70.00	63.00	
5"	12"	1 1/4"	.75	370058	70.00	63.00	370083	77.50	73.00	370108	70.00	63.00	
5 1/2"	12"	1 1/4"	.70	370059	70.00	63.00	370084	77.50	73.00	370109	70.00	63.00	
6"	12"	1 1/4"	.65	370060	70.00	63.00	370085	77.50	73.00	370110	70.00	63.00	
5"	16"	2 3/8"	1.4	370635	110.00	100.00	370636	126.00	116.00	370637	110.00	100.00	
6"	16"	2 3/8"	1.4	370061	110.00	100.00	370086	126.00	116.00	370111	110.00	100.00	
7"	16"	2 3/8"	1.4	370062	110.00	100.00	370087	126.00	116.00	370112	110.00	100.00	
8"	16"	2 3/8"	1.3	370063	110.00	100.00	370088	126.00	116.00	370113	110.00	100.00	
7"	22"	3 3/8"	2.5	370064	224.00	206.00	370089	243.00	221.00	370114	224.00	206.00	
8"	22"	3 3/8"	2.7	370065	224.00	206.00	370090	243.00	221.00	370115	224.00	206.00	
10"	22"	3 3/8"	2.9	370066	224.00	206.00	370091	243.00	221.00	370116	224.00	206.00	
8"	30"	4 1/4"	5.9	370067	537.00	491.00	370092	558.00	506.00	370117	537.00	491.00	
10"	30"	4 1/4"	5.4	370068	537.00	491.00	370093	558.00	506.00	370118	537.00	491.00	
12"	30"	4 1/4"	5.3	370069	537.00	491.00	370094	558.00	506.00	370119	537.00	491.00	
8"	38"	4 3/4"	7.5	370070	1,248.00	1,122.00	370095	1,347.00	1,215.00	370120	1,248.00	1,122.00	
10"	38"	4 3/4"	6.9	370071	1,248.00	1,122.00	370096	1,347.00	1,215.00	370121	1,248.00	1,122.00	
12"	38"	4 3/4"	6.7	370072	1,248.00	1,122.00	370097	1,347.00	1,215.00	370122	1,248.00	1,122.00	

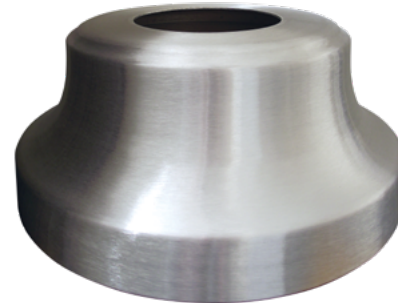

Satin

**HIGH PROFILE TRUMPET ALUMINUM FLASH COLLARS**

Trumpet collars are generally used with flagpoles where a shoe base is welded to the bottom; however, these collars can be used on standard in-ground mounted flagpoles if a higher profile is desired. Supplied in a standard wall thickness of .060". The chart below contains the most commonly requested sizes. If custom sizes are needed, call or email for pricing and availability.

Pole Dia.	Outside Dia.	Ht.	Lbs.	Satin						Clear			Bronze #313			Black			White		
				Item #	1-5	6+	Item #	1-5	6+	Item #	1-5	6+	Item #	1-5	6+	Item #	1-5	6+	Item #	1-5	6+
2½"	10"	3½"	1.5	370468	\$80	\$74	370478	\$103	\$91	370488	\$103	\$91	370498	\$118	\$105	370508	\$103	\$91			
3"	10"	2¾"	1.5	370469	80	74	370479	103	91	370489	103	91	370499	118	105	370509	103	91			
3"	16"	5¾"	1.5	370470	131	121	370480	167	153	370490	167	153	370500	188	175	370510	167	153			
4"	16"	5¾"	1.8	370471	131	121	370481	167	153	370491	167	153	370501	188	175	370511	167	153			
5"	16"	6¼"	1.7	370472	131	121	370482	167	153	370492	167	153	370502	188	175	370512	167	153			
6"	16"	7⅞"	1.7	370473	131	121	370483	167	153	370493	167	153	370503	188	175	370513	167	153			
7"	16"	7⅞"	1.6	370474	131	121	370484	167	153	370494	167	153	370504	188	175	370514	167	153			
8"	16"	7⅞"	1.6	370475	131	121	370485	167	153	370495	167	153	370505	188	175	370515	167	153			
10"	22"	8¼"	3.3	370476	274	250	370486	309	284	370496	309	284	370506	335	305	370516	309	284			
12"	26"	11"	4.9	370477	511	469	370487	587	522	370497	587	522	370507	609	544	370517	587	522			

**HIGH PROFILE SPLIT TRUMPET ALUMINUM FLASH COLLARS**

A split trumpet collar differs from a standard trumpet collar because it can be installed on a flagpole without removing the pole from the foundation sleeve. It's perfect for poles where a standard collar was not previously installed or when replacing damaged collars. The collar is split in half and mounting tabs with screws are installed on the under side of the collar. The quantity and size of the mounting tabs may vary depending on the size of the flash collar ordered. Supplied in a standard wall thickness of .060". The chart below contains the most commonly requested sizes. If custom sizes are needed, call or email for pricing and availability.

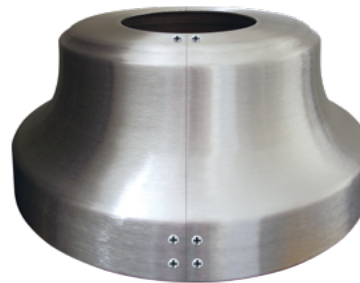

Satin

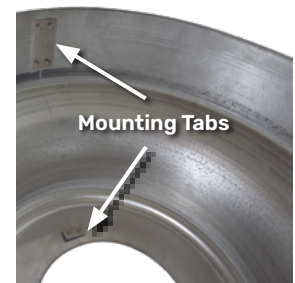

Pole Dia.	Outside Dia.	Ht.	Lbs.	Satin						Clear			Bronze #313			Black			White		
				Item #	1-5	6+	Item #	1-5	6+	Item #	1-5	6+	Item #	1-5	6+	Item #	1-5	6+	Item #	1-5	6+
2½"	10"	3"	2.0	370518	\$250	\$242	370528	\$284	\$271	370538	\$284	\$271	370548	\$293	\$284	370558	\$284	\$271			
3"	10"	3"	2.0	370519	250	242	370529	284	271	370539	284	271	370549	293	284	370559	284	271			
3"	16"	5¾"	2.0	370520	305	291	370530	344	326	370540	344	326	370550	354	337	370560	344	326			
4"	16"	5¾"	2.3	370521	305	291	370531	344	326	370541	344	326	370551	354	337	370561	344	326			
5"	16"	6¼"	2.2	370522	305	291	370532	344	326	370542	344	326	370552	354	337	370562	344	326			
6"	16"	7½"	2.2	370523	305	291	370533	344	326	370543	344	326	370553	354	337	370563	344	326			
7"	16"	7½"	2.1	370524	305	291	370534	344	326	370544	344	326	370554	354	337	370564	344	326			
8"	16"	7½"	2.1	370525	305	291	370535	344	326	370545	344	326	370555	354	337	370565	344	326			
10"	22"	8¼"	3.8	370526	442	413	370536	499	461	370546	499	461	370556	527	506	370566	499	461			
12"	26"	11"	5.4	370527	681	630	370537	764	695	370547	764	695	370557	790	712	370567	764	695			

# OUTDOOR FLAGPOLE ACCESSORIES

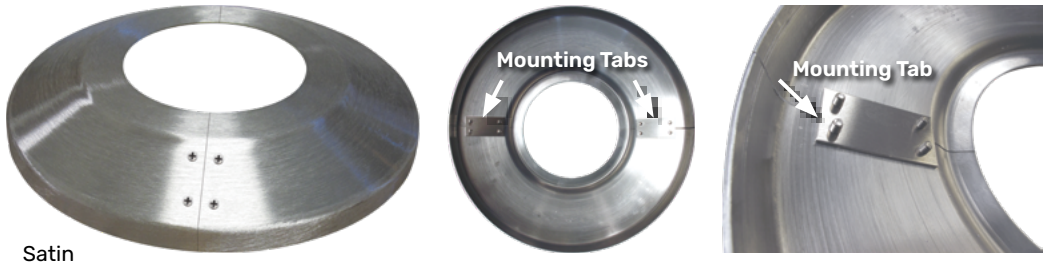

## STANDARD PROFILE SPLIT ALUMINUM FLASH COLLARS WITH .060" WALL THICKNESS

A split collar can be useful when replacing or adding a collar to an installed flagpole without removing the pole from the foundation sleeve. The collar is split in half and mounting tabs with screws are installed on the under side of the collar. The quantity and size of the mounting tabs may vary depending on the size of the flash collar ordered.

Pole Dia.	Outside			Item #	Satin		Clear			Bronze #313		Black		White				
	Dia.	Ht.	Lbs.		1-5	6+	1-5	6+	1-5	6+	1-5	6+	1-5	6+				
2"	8"	2 1/4"	.55	370233	\$188	\$172	370643	\$195	\$192	370281	\$195	\$192	370306	\$212	\$205	370331	\$195	\$192
2 3/8"	8"	2 1/4"	.50	370234	188	172	370258	195	192	370282	195	192	370307	212	205	370332	195	192
2 1/2"	8"	2 1/4"	.50	370235	188	172	370644	195	192	370283	195	192	370308	212	205	370333	195	192
2"	12"	1 1/4"	.85	370236	191	188	370259	212	205	370284	212	205	370309	218	213	370334	212	205
2 3/8"	12"	1 1/4"	.85	370237	191	188	370260	212	205	370285	212	205	370310	218	213	370335	212	205
2 1/2"	12"	1 1/4"	.85	370238	191	188	370261	212	205	370286	212	205	370311	218	213	370336	212	205
3"	12"	1 1/4"	.90	370239	191	188	370262	212	205	370287	212	205	370312	218	213	370337	212	205
3 1/2"	12"	1 1/4"	.85	370240	191	188	370263	212	205	370288	212	205	370313	218	213	370338	212	205
4"	12"	1 1/4"	.80	370241	191	188	370264	212	205	370289	212	205	370314	218	213	370339	212	205
4 3/8"	12"	1 1/4"	.80	370242	191	188	370265	212	205	370290	212	205	370315	218	213	370340	212	205
5"	12"	1 1/4"	.80	370243	191	188	370266	212	205	370291	212	205	370316	218	213	370341	212	205
5 1/2"	12"	1 1/4"	.75	370244	191	188	370267	212	205	370292	212	205	370317	218	213	370342	212	205
6"	12"	1 1/4"	.70	370245	191	188	370268	212	205	370293	212	205	370318	218	213	370343	212	205
5"	16"	2 1/2"	1.9	370645	221	214	370646	251	242	370647	251	242	370648	268	255	370649	251	242
6"	16"	2 1/2"	1.9	370246	221	214	370269	251	242	370294	251	242	370319	268	255	370344	251	242
7"	16"	2 1/2"	1.9	370247	221	214	370270	251	242	370295	251	242	370320	268	255	370345	251	242
8"	16"	2 1/2"	1.8	370248	221	214	370271	251	242	370296	251	242	370321	268	255	370346	251	242
7"	22"	3 1/2"	3.0	370249	327	308	370272	393	373	370297	393	373	370322	402	380	370347	393	373
8"	22"	3 1/2"	3.2	370250	327	308	370273	393	373	370298	393	373	370323	402	380	370348	393	373
10"	22"	3 1/2"	3.4	370251	327	308	370274	393	373	370299	393	373	370324	402	380	370349	393	373
8"	30"	4 1/4"	6.4	370252	582	536	370275	695	646	370300	695	646	370325	713	664	370350	695	646
10"	30"	4 1/4"	5.9	370253	582	536	370276	695	646	370301	695	646	370326	713	664	370351	695	646
12"	30"	4 1/4"	5.8	370254	582	536	370277	695	646	370302	695	646	370327	713	664	370352	695	646
8"	38"	4 3/4"	8.0	370255	1,300	1,175	370278	1,454	1,325	370303	1,454	1,325	370328	1,557	1,423	370353	1,454	1,325
10"	38"	4 3/4"	7.4	370256	1,300	1,175	370279	1,454	1,325	370304	1,454	1,325	370329	1,557	1,423	370354	1,454	1,325
12"	38"	4 3/4"	7.2	370257	1,300	1,175	370280	1,454	1,325	370305	1,454	1,325	370330	1,557	1,423	370355	1,454	1,325

## GALVANIZED STEEL FOUNDATION SLEEVES

The most common type of flagpole installation is the in-ground foundation sleeve method which calls for 1' of the flagpole to be encased in the ground sleeve for each 10' of exposed flagpole height. The diameter of the sleeve should be at least 2" greater than the outside butt diameter of the flagpole with the area between the flagpole and the sleeve filled with dry sand. Sleeves

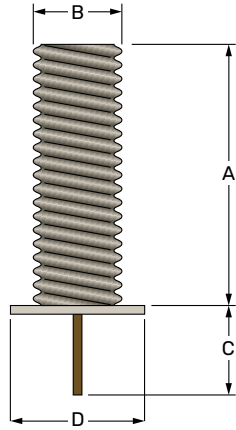

### WITH BASE PLATE & GROUNDING SPIKE

Item #	A	B	C	D	1-5	6+	Lbs.
380000	2'	6"	6"	8"	\$150	\$144	20
380002	3'	6"	6"	8"	193	187	24



## PVC SLEEVES

Poles slip into form fit sleeves snugly - no voids to fill with sand. Standard sleeves require wood wedges & sand for a proper installation.

Item #	For Pole Dia.	Len.	Type	1-5	6+	Lbs.
380015	1-3/8"	12"	Form Fit	\$11.30	\$10.00	.14
380016	1-5/8"	15"	Form Fit	13.40	12.20	.20
380017	1-3/4"	20"	Form Fit	15.50	14.20	.26
380018	2"	15"	Form Fit	20.30	18.10	.25
380020	2"	20"	Form Fit	21.90	20.30	.34
380021	2-1/2"	30"	Form Fit	29.40	27.70	1.1
380022	3"	20"	Form Fit	36.10	34.30	.95
380023	3"-3/2"	24"	Standard	31.70	30.00	1.6
380024	3"-3/2"	30"	Standard	43.50	42.10	1.9

with a 6" diameter are supplied with a base plate and grounding spike. Sleeves with a diameter greater than 6" are supplied with a base plate, support plate, grounding spike and, for ease of vertical alignment, steel centering structure welded to the inside of the base plate. If you require sizes other than listed or have special on-site conditions, please contact us.

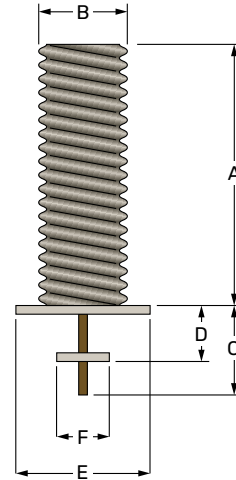

### WITH BASE PLATE, SUPPORT PLATE, GROUNDING SPIKE & STEEL CENTERING STRUCTURE

\* 4' & 4-1/2' ground sleeves are available in both one and two piece options. The two piece option would allow for parcel carrier shipping. Please contact a sales representative for details.

Item#	A	B	C	D	E	F	1-5	6+	Lbs.
380003	3'	8"	18"	6"	12"	6"	\$273	\$249	30
380004	3-1/2'	8"	18"	6"	12"	6"	279	258	32
380005	3'	10"	18"	6"	16"	8"	294	278	37
380006	3-1/2'	10"	18"	6"	16"	8"	314	299	44
380007	4**	12"	18"	6"	16"	8"	423	404	55
380196	4-1/2**	12"	18"	6"	16"	8"	455	428	60
380008	5'	12"	18"	6"	18"	9"	498	473	70
380009	5'	15"	18"	6"	20"	10"	882	837	86
380010	6'	15"	24"	10"	20"	10"	1,019	974	122
380011	6'	18"	24"	10"	24"	12"	1,131	1,073	135
380012	7'	15"	24"	12"	24"	12"	1,131	1,073	141
380013	7'	18"	24"	12"	24"	12"	1,311	1,246	156
380014	8'	18"	24"	12"	24"	12"	1,401	1,335	160

# OUTDOOR FLAGPOLE ACCESSORIES

SLEEVES, LIGHTS & MISCELLANEOUS

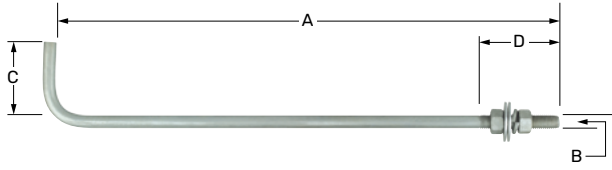

## GALVANIZED STEEL ANCHOR BOLTS

- For shoe base installations
- Complete with 2 hex nuts, 2 washers & 1 lock washer

Item #	A	B	C	D	1-5	6+	Lbs.
380037	16"	5/8"	3-1/2"	4"	\$43	\$39	2.4
380038	24"	3/4"	4"	5"	46	42	3.5
380039	36"	1"	4"	6"	88	86	8.4
380040	40"	1"	4"	6"	96	93	9.0
380041	54"	1-1/4"	6"	8"	227	205	29



## THRU WALL BOLTS

- For mounting Outrigger & Vertical Wall Mount brackets
- Zinc plated steel complete with one acorn nut, one hex nut, two washers & two lock washers.

Item #	Size	Color	1-5	6+	Lbs
380048	5/8" x 6"	Silver	\$25.50	\$24.50	.75
380049	5/8" x 12"	Silver	30.50	29.50	1.2
380050	5/8" x 18"	Silver	31.00	29.50	1.7
380051	5/8" x 24"	Silver	32.00	30.00	2.1
380052	5/8" x 30"	Silver	33.00	32.00	2.5
380053	5/8" x 36"	Silver	37.50	34.50	2.9



## COPPER CLAD LIGHTNING KIT

Each kit contains a 5' long by 1/2" diameter copper clad rod, one 3' long by 1/2" diameter copper wire plus one connecting bracket.

### Complete Set

Item #	1-5	6+	Lbs.
380033	\$200	\$179	4.5

### 5' X 1/2" Rod Only

Item #	Price	Lbs.
380035	\$111	1.2

### Wire Only

Item #	Per Foot	Lbs.
380034	\$16.40	.36

### Bracket Only

Item #	1-5	6+	Lbs.
380036	\$64	\$59	.36

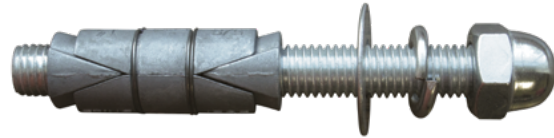

## MOUNTING BOLT WITH EXPANSION SHIELD

- For mounting Outrigger & Vertical Wall Mount brackets
- Zinc plated steel complete with one acorn nut, one washer, one lock washer, and one expansion shield.

Item #	Size	Color	1-5	6+	Lbs
380103	5/8" x 6"	Silver	\$29.50	\$28.00	.81

## TUNNEL LIGHTS

Sold in sets only - 18" long by 6" diameter aluminum cylinders. Fixtures accept 150 watt or PAR 38 LED outdoor flood lamps for up, down or up/down lighting (lamps not included in the pricing below). See table below for wiring set-up cost which is not included in tunnel light pricing.



For Pole Dia.	Lbs	Item #	Silver		Clear			Bronze #313			White			Black		
			1-5	6+	Item #	1-5	6+	Item #	1-5	6+	Item #	1-5	6+	Item #	1-5	6+
5" - 7"	18	380112	\$1,750	\$1,590	380119	\$2,020	\$1,810	380126	\$2,020	\$1,810	380133	\$2,020	\$1,810	380140	\$2,020	\$1,810
8" - 12"	18	380116	2,020	1,810	380123	2,190	2,020	380130	2,190	2,020	380137	2,190	2,020	380144	2,190	2,020

Pole Type	Access Door	Price
External	No	\$590.00
External	Yes	1,050.00
Internal	No	710.00
Internal	Yes	1,320.00

## ADD ON FOR FACTORY SET-UP OF WIRING

Electrical access doors can only be supplied on 5" and larger diameter poles with a minimum wall thickness of .156. For flagpoles with tunnel lights and access door, please allow 20-24 weeks of lead time.

**DELUXE LED SOLAR FLAGPOLE LIGHT**

This solar-powered flagpole light is ideal for residential flagpoles 15' to 25'

- 200 x 1W ultra brite SMD 2835 LEDs, 1100 lumens
- Two 3.2V 4000 mAh LiFePO4 batteries (8000mAh total)
- 5v 6.2w efficiency monocrystalline solar panels
- IP65 rated water resistant
- Light Dimension is 10" x 10" x 1.5"
- For use with all trucks except for the ST series



Item#	Color	1-5	6+	Lbs
380209	White	\$132.00	\$125.00	1.9
380212	Black	\$132.00	\$125.00	1.9



**TUNNEL LIGHT REPLACEMENT LENS**

Item #	1-5	6+	Lbs
380190	\$250	\$230	.33



**OBSTRUCTION (BEACON) LIGHT**

This light measures 6" x 4-3/4" and is ideal for taller flagpoles near airports or flight paths. ETL verified to FAA standards. Supplied standard with LED steady-burn bulb; please contact us if flasher unit is required. Set-up of flagpole to accept this lighting fixture can be done at the factory; call for pricing.

Model	Item #	1-5	6+	Lbs.
OL-R	380148	\$720	\$700	2.8

**TOUCH-UP PAINT**

12 oz. Aerosol Spray. Aerosol sprays cannot be shipped by air freight.

Model	Item #	Color	1-5	6+	Lbs
TUP-AL	390006	Aluminum/clear	\$64	\$61	1.0
TUP-311	390007	Light Bronze #311	64	61	1.0
TUP-312	390008	Med. Bronze #312	64	61	1.0
TUP-313	390009	Dark Bronze #313	64	61	1.0
TUP-BL	390010	Black	64	61	1.0
TUP-WH	390011	White	64	61	1.0
TUP-G	390012	Gold	64	61	1.0



# OUTDOOR FLAGPOLE ACCESSORIES

## NON-TANGLE RODS

### For Wall Mounted Outrigger Flagpoles

Crafted from durable 3/8" diameter stainless steel rod. Each size includes stainless steel fittings designed to securely attach to the flag's grommets.

- 30" and 48" lengths include one stainless steel fitting for attachment to the bottom edge of the flag.
- 72" and 84" lengths include three stainless steel fittings for secure attachment along the bottom edge.

Note: A reinforcing patch must be sewn into the flag to ensure proper attachment of the flag clamp. For optimal safety and performance, regular inspection of the rope and flag is recommended.



## FLAGPOLE PLAQUES

Engraved brass plaques are available and are curved to fit the butt diameter of the flagpole. Letter styles available are block or roman style. The plaques are supplied with brass rivets.

Please specify flagpole base diameter when ordering.

**BLOCK  
STYLE  
LETTERING**

**ROMAN  
STYLE  
LETTERING**

Pole Diameter	Price
3"	\$118.00 + \$5.50 Per Letter
4", 5", 6"	\$150.00 + \$5.50 Per Letter



Model	Item #	Length	For Flag Size	1-5	6+	Lbs.
NTR-30	390000	30"	3' x 5' or 4' x 6'	\$240	\$230	1.6
NTR-48	390001	48"	5' x 8'	265	240	2.3
NTR-72	390002	72"	6' x 10'	365	325	3.1
NTR-84	390003	84"	8' x 12'	375	345	4.3

## 5' FLAGPOLE MOCK-UPS

Pole Type	Model	Item #	Price	Lbs.
External Halyard	FMU-X	390013	\$770	19
Vanguard Internal Halyard	FMU-Y	390014	1,040	22
M-Winch Internal Halyard	FMU-M	390015	1,800	25

External Halyard

Vanguard Internal Halyard

M-Winch Internal Halyard



All sales will be subject to the terms and conditions contained herein. An objection by Buyer to any of the terms contained herein shall be deemed to have been waived if Eder Flag Manufacturing Co., Inc. (EFMC) does not receive the objection in writing within 10 days of receipt of invoice or acknowledgment or before part of the merchandise or services is accepted by Buyer, whichever may occur first.

1. **WARRANTY DISCLAIMER.** All products made by EFMC are inspected before shipment. If any goods prove to have been defective in material or workmanship at time of shipment, a claim shall be made by Buyer pursuant to the provisions set forth below. EFMC will repair or replace the goods at EFMC's discretion. Unless otherwise agreed by EFMC in writing, EFMC makes no warranties, express or implied. In no event shall EFMC be liable to Buyer for incidental or consequential damages.
2. **STATUTE OF LIMITATIONS.** Any action by Buyer against EFMC for breach of contract or any other legal theory must be commenced by Buyer within (1) year after the cause of action has occurred.
3. **RETURNS.** All returns must be authorized in advance by EFMC within (10) days of receipt of goods by Buyer. Buyer must pre-pay all freight on authorized returned goods. Freight claims resulting from return shipment are the responsibility of Buyer. Credit on account minus a restocking charge will be made upon inspection of returned goods. Custom, non-stock and special order items are not returnable. Returns will not be accepted after (10) days from receipt of merchandise and no adjustments of any kind will be made after 90 days from receipt of merchandise.
4. **SHORTAGES.** Claims for shortages must be made by Buyer within 48 hours of receipt of the goods, and no claims made after the expiration of such period will be entertained or allowed.
5. **DELAYS.** All orders are accepted by EFMC upon the express understanding by the Buyer that EFMC shall not be liable for delays in delivery of the goods or inability to deliver the goods caused by or due to inability to obtain transportation, equipment, or material, or by reason of fires, floods, storms, embargoes, actions of any military or civil authorities, whether legal or de facto, strikes, labor difficulties, riots, lock outs, acts of God, or similar or different circumstances beyond the control of the EFMC.
6. **FREIGHT.** All costs of freight, transportation, or mailing, unless prepaid, and all demurrage charges shall be paid by Buyer. Buyer shall also pay for all increased freight rates whether prepayment for freight rates has been made or not. Likewise, if freight charges have been prepaid and the actual freight charges are less than quoted, Buyer forfeits the difference.
7. **WAIVER.** A waiver by EFMC of any breach by Buyer shall not constitute a waiver by EFMC of any other breach by Buyer.
8. **DELIVERY.** Delivery of the goods by EFMC to the carrier at the point of origin shall constitute delivery of the goods to Buyer and thereafter the shipment of the goods shall be at Buyer's risk. All claims and allowances for damage to the merchandise incurred in transit must be filed against and presented to the carrier by Buyer. EFMC is not responsible for any delay, damage, or loss when goods are shipped under a buyers shipping account. Goods sent by mail are insured at cost of Buyer. See [ederflag.com](http://ederflag.com) for additional shipping details.
9. **PAYMENT.** Prices Net 15 to approved credit. Terms are from date of invoice and not from date the goods are received. No extra dating. All payments shall be made in U.S. dollars. Any amounts past due are subject to a service charge of 1.5% per month (18% annually) starting 30 days after invoice date. The minimum merchandise billing amount of \$75.00 net and a service charge of \$5.00 will be charged on orders less than the minimum. **Credit/Debit Card Payments:** All credit/debit card payments will incur a convenience fee. If a credit/debit card payment is used at time of shipment, a 2% convenience fee will be added to the invoice. If a credit/debit card payment is used to pay an outstanding balance, net terms, a 3% convenience fee will be added to the invoice total. ACH and check payments are the preferred method of payment.
10. **CUSTOM PRODUCT.** Custom screen printed banners and flags are subject to variation in quantity. All orders subject to plus/minus 10% variance. Order accepted only on the basis that final invoice will reflect actual quantity delivered and Buyer agrees to accept and pay for overruns. All prices and specifications subject to change without notice. Deposit required for all custom and applique items, please see a customer service associate for details.
11. **CANCELLATIONS.** Orders for custom, non-stock and special order items cannot be cancelled except upon terms acceptable to EFMC that will compensate EFMC for costs incurred.

*Continued on next page*

## TERMS & CONDITIONS

- 12. BACK ORDERS.** EFMC policy is to ship all available merchandise and back order the balance unless otherwise specified by the Buyer. Therefore, Buyer must accept partial shipments and pay partial invoices, handling fees and additional freight charges within EFMC payment terms.
- 13. DIES, TOOLS AND PATTERNS.** Charges made for dies, tools and patterns are part of the purchase price of the goods and do not convey ownership to Buyer. All dies, tools and patterns remain the property of EFMC, unless agreed by EFMC in writing.
- 14. COLLECTION.** Any collection fees, legal fees and/or court costs will be the responsibility of the Buyer in event of default based upon the terms of this agreement. In respect to such matters, legal fees by Buyer to EFMC will be defined as thirty-three and one-third percent (33⅓%) of any unpaid invoice. The jurisdiction of any and all legal disputes is the Circuit Court of Milwaukee County, Wisconsin. All parties waive the right to trial by jury.
- 15. SHIPPING WEIGHTS, PRICES and SPECIFICATIONS.** Weights published by EFMC are approximate and will vary according to size of shipping carton and/or packaging materials used. Weights are published for determining approximate freight charges by Buyer. EFMC is not responsible for any difference in calculated freight charges versus actual freight charges. All prices and specifications are subject to change without notice.
- 16. HANDLING FEES AND TAXES.** A \$3.00 Shipping and Handling Fee is added to each invoice. Where required by applicable law, sales taxes will be collected and remitted to the appropriate tax authority. To the extent known at the time of invoicing, such taxes will be added to any invoice and Buyer is responsible for all sales and use taxes. Properly completed and valid sales and use tax exemption certificates may reduce or eliminate the legal requirement to collect and remit sales taxes, if timely submitted to EFMC.
- 17. PRICING AND AVAILABILITY DISCLAIMER.** All pricing is subject to change. EFMC reserves the right to make adjustments to pricing, product and service offerings for reasons including, but not limited to, changing market condition, production discontinuations, product unavailability and errors in advertisements. All orders may be subject to product availability.

We accept ACH, Check, Visa, MasterCard and American Express

**RETAILER RESOURCES – ONLINE**

Our free retailer portal streamlines your entire ordering experience – from the moment you place an order to final fulfillment.



**Inventory and Pricing:** Gain instant access to a comprehensive list of detailed inventory listings and up-to-date pricing information.



**View Order Status:** Track your orders in real time, keeping you informed about the status of your purchases from processing to delivery.



**Efficient Ordering:** Streamline your ordering process with user-friendly tools that make placing orders faster and more convenient.



**Live Tracking:** Gain visibility into the shipping process with live tracking, giving you peace of mind and enhancing your customer service.



**24/7 Availability:** Enjoy the flexibility to place orders at any time, allowing you to manage your business effectively on your schedule.



**Account Review:** Convenient access to review your statements, balances, and invoices for efficient account management.

Please visit [ederflag.com/pages/dealer-portal](https://ederflag.com/pages/dealer-portal) to access our retailer portal, view current dealer promotions, catalogs and shop drawings.

Email [sales@ederflag.com](mailto:sales@ederflag.com) for more information.

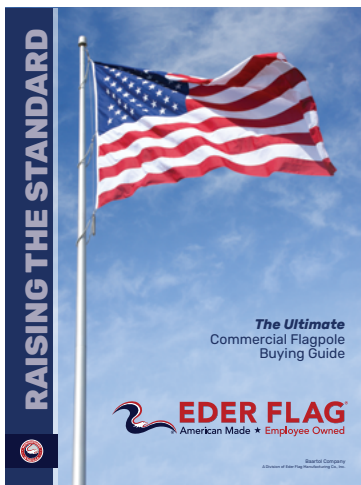

**The Ultimate Commercial Flagpole Buying Guide**

This new tool is specifically designed with the flagpole salesperson in mind. You will find commercial poles and accessories featured here, along with new descriptions and updated illustrations in a step-by-step guide for you and your customers.

Item #	Net Price
420057	\$5.00

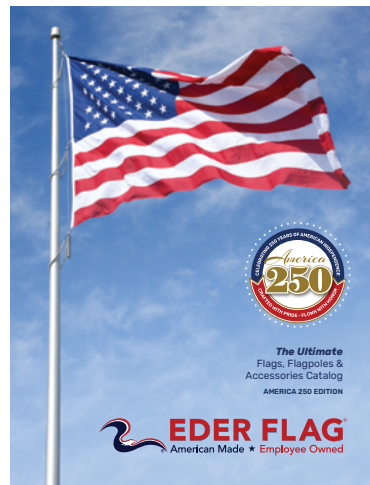

**The Ultimate Flags, Flagpoles & Accessories Catalog - AMERICA 250 EDITION**

Need additional industry-leading dealer catalogs? Order extra copies of our 2026 catalog, featuring our entire inventory of products.

Item #	Net Price
420056	\$10.00



***The Ultimate***  
**Flags, Flagpoles &  
Accessories Catalog**  
**AMERICA 250 EDITION**



**EDER FLAG**<sup>®</sup>  
American Made ★ Employee Owned

**The largest company in America  
that serves as both a flag and  
flagpole manufacturer.**

Eder Flag Manufacturing Company, Inc.  
1000 W. Rawson Ave.  
Oak Creek, Wisconsin 53154-0397

Phone: 414-764-3522  
Toll-Free Phone: 800-558-6044  
Sales Department Fax: 414-764-1039

Inquiries or orders for stock products:  
[sales@ederflag.com](mailto:sales@ederflag.com)

Quotes or orders for custom flags, banners &  
appliqué: [customdepartment@ederflag.com](mailto:customdepartment@ederflag.com)

Inquiries, quotes, or orders for flagpoles:  
[flagpoles@ederflag.com](mailto:flagpoles@ederflag.com)

**ederflag.com**

Baartol Company  
A Division of Eder Flag Manufacturing Co., Inc.